



**NONRESIDENT  
TRAINING  
COURSE**



June 1994

---

# **Journalist 3 & 2**

**NAVEDTRA 14130**

Although the words “he,” “him,” and “his” are used sparingly in this course to enhance communication, they are not intended to be gender driven or to affront or discriminate against anyone.

COMMANDING OFFICER  
NETPDTC  
6490 SAUFLEY FIELD ROAD  
PENSACOLA FL 32509-5237

20 Jul 99

ERRATA # 1

Specific Instructions and Errata for  
Nonresident Training Course

JOURNALIST 3&2

1. To obtain credit for deleted questions, show this errata to your local course administrator (ESO/scorer). The local course administrator is directed to correct the course and answer key by indicating the questions deleted.

2. No attempt has been made to issue corrections for errors in typing, punctuation, etc., which do not affect your ability to answer the question.

3. Assignment Booklet

Delete the following questions and leave the corresponding spaces blank on the answer sheet:

Questions

1-9  
1-39  
1-40  
1-42  
1-60  
5-22  
6-45  
7-13  
7-36  
7-65

Questions

8-32  
11-3  
11-34  
11-35  
12-24  
12-47  
13-13  
13-35  
13-36  
13-37



## PREFACE

By enrolling in this self-study course, you have demonstrated a desire to improve yourself and the Navy. Remember, however, this self-study course is only one part of the total Navy training program. Practical experience, schools, selected reading, and your desire to succeed are also necessary to successfully round out a fully meaningful training program.

**THE COURSE:** This self-study course is organized into subject matter areas, each containing learning objectives to help you determine what you should learn along with text and illustrations to help you understand the information. The subject matter reflects day-to-day requirements and experiences of personnel in the rating or skill area. It also reflects guidance provided by Enlisted Community Managers (ECMs) and other senior personnel, technical references, instructions, etc., and either the occupational or naval standards, which are listed in the *Manual of Navy Enlisted Manpower Personnel Classifications and Occupational Standards*, NAVPERS 18068.

**THE QUESTIONS:** The questions that appear in this course are designed to help you understand the material in the text.

**VALUE:** In completing this course, you will improve your military and professional knowledge. Importantly, it can also help you study for the Navy-wide advancement in rate examination. If you are studying and discover a reference in the text to another publication for further information, look it up.

*1994 Edition Prepared by  
JOC Dave Marr*

Published by  
NAVAL EDUCATION AND TRAINING  
PROFESSIONAL DEVELOPMENT  
AND TECHNOLOGY CENTER

**NAVSUP Logistics Tracking Number  
0504-LP-026-7890**

## **Sailor's Creed**

“I am a United States Sailor.

I will support and defend the Constitution of the United States of America and I will obey the orders of those appointed over me.

I represent the fighting spirit of the Navy and those who have gone before me to defend freedom and democracy around the world.

I proudly serve my country's Navy combat team with honor, courage and commitment.

I am committed to excellence and the fair treatment of all.”

# CONTENTS

<b>CHAPTER</b>	<b>PAGE</b>
1. The Navy Journalist . . . . .	1-1
2. Basic Newswriting . . . . .	2-1
3. Writing the Feature Speech, Sports and Accident Stories . . . . .	3-1
4. Writing for Magazines . . . . .	4-1
5. Advance Stories, Follow-ups and Rewrites . . . . .	5-1
6. Copy Editing . . . . .	6-1
7. Gathering and Disseminating Navy News . . . . .	7-1
8. Printing, Layout and Makeup . . . . .	8-1
9. Writing Headlines and Cutlines . . . . .	9-1
10. Libel, Right of Privacy, Freedom of Information . . . . . and Copyright	10-1
11. Basic Photography . . . . .	11-1
12. Basic Photojournalism . . . . .	12-1
13. Radio. . . . .	13-1
14. Television . . . . .	14-1
15. Radio and Television Interviewing . . . . .	15-1
16. Public Affairs Office Operations. . . . .	16-1
17. Home Town News . . . . .	17-1
<b>APPENDIX</b>	
I. Glossary . . . . .	AI-1
II. References Used to Develop the TRAMAN . . . . .	AII-1
INDEX . . . . .	.INDEX-1

# INSTRUCTIONS FOR TAKING THE COURSE

## ASSIGNMENTS

The text pages that you are to study are listed at the beginning of each assignment. Study these pages carefully before attempting to answer the questions. Pay close attention to tables and illustrations and read the learning objectives. The learning objectives state what you should be able to do after studying the material. Answering the questions correctly helps you accomplish the objectives.

## SELECTING YOUR ANSWERS

Read each question carefully, then select the BEST answer. You may refer freely to the text. The answers must be the result of your own work and decisions. You are prohibited from referring to or copying the answers of others and from giving answers to anyone else taking the course.

## SUBMITTING YOUR ASSIGNMENTS

To have your assignments graded, you must be enrolled in the course with the Nonresident Training Course Administration Branch at the Naval Education and Training Professional Development and Technology Center (NETPDTC). Following enrollment, there are two ways of having your assignments graded: (1) use the Internet to submit your assignments as you complete them, or (2) send all the assignments at one time by mail to NETPDTC.

**Grading on the Internet:** Advantages to Internet grading are:

- you may submit your answers as soon as you complete an assignment, and
- you get your results faster; usually by the next working day (approximately 24 hours).

In addition to receiving grade results for each assignment, you will receive course completion confirmation once you have completed all the

assignments. To submit your assignment answers via the Internet, go to:

<http://courses.cnet.navy.mil>

**Grading by Mail:** When you submit answer sheets by mail, send all of your assignments at one time. Do NOT submit individual answer sheets for grading. Mail all of your assignments in an envelope, which you either provide yourself or obtain from your nearest Educational Services Officer (ESO). Submit answer sheets to:

COMMANDING OFFICER  
NETPDTC N331  
6490 SAUFLEY FIELD ROAD  
PENSACOLA FL 32559-5000

**Answer Sheets:** All courses include one “scannable” answer sheet for each assignment. These answer sheets are preprinted with your SSN, name, assignment number, and course number. Explanations for completing the answer sheets are on the answer sheet.

**Do not use answer sheet reproductions:** Use only the original answer sheets that we provide—reproductions will not work with our scanning equipment and cannot be processed.

Follow the instructions for marking your answers on the answer sheet. Be sure that blocks 1, 2, and 3 are filled in correctly. This information is necessary for your course to be properly processed and for you to receive credit for your work.

## COMPLETION TIME

Courses must be completed within 12 months from the date of enrollment. This includes time required to resubmit failed assignments.



## **PASS/FAIL ASSIGNMENT PROCEDURES**

If your overall course score is 3.2 or higher, you will pass the course and will not be required to resubmit assignments. Once your assignments have been graded you will receive course completion confirmation.

If you receive less than a 3.2 on any assignment and your overall course score is below 3.2, you will be given the opportunity to resubmit failed assignments. **You may resubmit failed assignments only once.** Internet students will receive notification when they have failed an assignment--they may then resubmit failed assignments on the web site. Internet students may view and print results for failed assignments from the web site. Students who submit by mail will receive a failing result letter and a new answer sheet for resubmission of each failed assignment.

## **COMPLETION CONFIRMATION**

After successfully completing this course, you will receive a letter of completion.

## **ERRATA**

Errata are used to correct minor errors or delete obsolete information in a course. Errata may also be used to provide instructions to the student. If a course has an errata, it will be included as the first page(s) after the front cover. Errata for all courses can be accessed and viewed/downloaded at:

<http://www.advancement.cnet.navy.mil>

## **STUDENT FEEDBACK QUESTIONS**

We value your suggestions, questions, and criticisms on our courses. If you would like to communicate with us regarding this course, we encourage you, if possible, to use e-mail. If you write or fax, please use a copy of the Student Comment form that follows this page.

## **For subject matter questions:**

E-mail: n313.products@cnet.navy.mil  
Phone: Comm: (850) 452-1001, Ext. 2167  
DSN: 922-1001, Ext. 2167  
FAX: (850) 452-1370  
(Do not fax answer sheets.)  
Address: COMMANDING OFFICER  
NETPDTC (CODE N313)  
6490 SAUFLEY FIELD ROAD  
PENSACOLA FL 32509-5237

## **For enrollment, shipping, grading, or completion letter questions**

E-mail: fleetservices@cnet.navy.mil  
Phone: Toll Free: 877-264-8583  
Comm: (850) 452-1511/1181/1859  
DSN: 922-1511/1181/1859  
FAX: (850) 452-1370  
(Do not fax answer sheets.)  
Address: COMMANDING OFFICER  
NETPDTC (CODE N331)  
6490 SAUFLEY FIELD ROAD  
PENSACOLA FL 32559-5000

## **NAVAL RESERVE RETIREMENT CREDIT**

If you are a member of the Naval Reserve, you will receive retirement points if you are authorized to receive them under current directives governing retirement of Naval Reserve personnel. For Naval Reserve retirement, this course is evaluated at 20 points. This points will be credited as follows:

Unit 1: 12 points for the satisfactory completion of Assignments 1 through 8.

Unit 2: 8 points for the satisfactory completion of Assignments 9 through 13.

(Refer to *Administrative Procedures for Naval Reservists on Inactive Duty*, BUPERSINST 1001.39, for more information about retirement points.)

## **COURSE OBJECTIVES**

In completing this nonresident training course, you will demonstrate a knowledge of the subject

matter by correctly answering questions on the following topics regarding the Navy journalist: Basic Newswriting; Writing the Feature, Speech, Sports and Accident Stories; Writing for Magazines; Advance Stories, Follow-ups and Rewrites; Copy Editing; Gathering and Disseminating Navy News; Printing, Layout,

and Makeup; Writing Headlines and Cutlines; Libel, Right of Privacy, Freedom of Information, and Copyright; Basic Photography; Basic Photojournalism; Radio; Television; Radio and Television Interviewing; Public Affairs Office Operations; and Home Town News.

## Student Comments

**Course Title:** Journalist 3 & 2

**NAVEDTRA:** 14130 **Date:** \_\_\_\_\_

**We need some information about you:**

Rate/Rank and Name: \_\_\_\_\_ SSN: \_\_\_\_\_ Command/Unit \_\_\_\_\_

Street Address: \_\_\_\_\_ City: \_\_\_\_\_ State/FPO: \_\_\_\_\_ Zip \_\_\_\_\_

**Your comments, suggestions, etc.:**

**Privacy Act Statement:** Under authority of Title 5, USC 301, information regarding your military status is requested in processing your comments and in preparing a reply. This information will not be divulged without written authorization to anyone other than those within DOD for official use in determining performance.

NETPDTC 1550/41 (Rev 4-00)



## CHAPTER 1

# THE NAVY JOURNALIST

To the young man or woman choosing a Navy career field, whether for one enlistment or for 30 years, the journalist rating offers endless avenues for an imaginative, yet mature, thinker.

Many of the duties and responsibilities of the journalist rank among Americans' favorite hobbies and pastimes, such as writing, broadcasting and photography. The Navy journalist learns and practices a distinguished profession and becomes an official representative of the Navy in public affairs matters.

The first enlisted specialists to work full time in the field of Navy journalism were Naval Reserve personnel selected during the early years of World War II. They were designated Specialist X (Naval Correspondents). In 1948, under a major overhaul affecting almost every enlisted rating, the journalist (JO) rating was established.

### MAJOR TASKS AND RESPONSIBILITIES

*LEARNING OBJECTIVE: Identify the major tasks and responsibilities of the Navy journalist, the personal traits required for one to best perform the duties of the rating, the applicable NECs, and the purpose of the JO 3 & 2 training manual (TRAMAN).*

In our democratic society, government depends on the consent of the governed. This important principle means that, in the long run, the United States government does only what the people want it to do. Therefore, we can have a Navy only if the people know and understand the importance of the Navy and support it.

The Navy, like the other services, depends on this country's citizens for the four key tools of its trade — personnel, money, materials and the authority to carry out its mission. As a Navy journalist, your main function will be to make the facts about your Navy available to the Navy's three main publics — the people at your ship or station, Navy people in general and the people of the United States as a whole.

Your CO is responsible for informing the Navy's publics. Your responsibility is to assist your command's public affairs officer (PAO) in accomplishing the Navy's and the command's public affairs goals.

Some of the key assignments for Navy journalists include the following:

- Writing Navy news releases and feature articles from personal interviews, examination of messages or witnessing events
- Taking and processing news photographs and writing cutlines
- Preparing material for commercial radio and television use
- Serving on the staff of an Armed Forces Radio and Television Service (AFRTS) station or Navy Broadcasting Service (NBS) detachment as an interviewer or announcer (subject to the requirements for voice quality, public speaking, presence and sense of timing)
- Preparing command histories and CO, XO and C/MC biographies
- Rewriting and localizing news releases received from the Navy Internal Relations Activity (NIRA) and other sources throughout the naval establishment
- Coordinating special events
- Editing material and preparing copy, art and layouts for the printing of Navy publications, such as ship and station newspapers, command information brochures, welcome aboard brochures, cruisebooks and fact sheets
- Assisting in the preparation of speeches and other presentations on naval topics
- Preparing material on individual Navy members for release to the Navy's Fleet Home Town News Center
- Preparing official correspondence and directives and performing other administrative functions in a public affairs office

To perform these duties well, you need to master verbal, oral and visual communication techniques. You must be a constant reader who is always abreast of current events in and out of the Navy. You must know enough about the Navy to interpret and translate its activities and actions intelligently to the civilian public. In the performance of their duties, journalists are expected to produce smooth copies of their own material. Therefore, you must be a qualified typist who meets the established standards for speed and accuracy. You also must be computer literate.

Finally, a journalist must have the ability to learn, and your main learning objective must be learning to write well. You must be better than average in your use of the English language. You must learn to write quickly, plainly and accurately. Your aim is to turn out news copy that can be used by a newspaper or radio/television station with a minimal need for editing or rewriting.

The major areas in which you will be expected to develop knowledge and skills include newswriting, editing and the layout and makeup of Navy publications. Other areas are the principles of printing, radio and television, photography and administration.

As you progress in experience, maturity and service seniority, you likely will become the trusted executive of the PAO. As such, you will find yourself performing many of the functions of a PAO. This will be particularly true if your boss is a collateral-duty PAO. Collateral duty means that the officer has other assignments that are considered primary duties. In such cases his primary responsibilities often allow only minimum time for public affairs work. Therefore, you also must learn the theory and practice of public affairs policy.

## **A COMMON MISPERCEPTION**

There is a tendency for Navy journalists to believe they are part of America's free press and thus part of the investigative journalist corps. This notion could not be further from the truth.

The moniker "Navy journalist" is misleading because the JO is a **public information specialist** — not a free press journalist. Navy journalists are assigned to command information, public information and community relations duties. When assigned to public information staffs, Navy journalists write releases to tell the Navy story and to respond to queries by the investigative free press. When assigned to command information staffs, Navy journalists may write for civilian enterprise (CE) or funded command

newspapers — what the industry terms "in-house" publications.

Just as a writer for commercial industry would not write investigative articles concerning his company for the in-house publication, Navy journalists would not write investigatively concerning their own individual commands or the Navy. Navy journalists may tackle controversial social issues in print or on videotape, but they must avoid works that attack or injure, or that give the impression of attacking or injuring their commands or the Navy.

## **NEWS IN THE NAVY COMMUNITY**

New Navy journalists are often confused about their role in the Navy community. Most are familiar with the print and electronic media back home. They are used to the civilian reporter investigating, or reporting on the investigation of fraud, waste or abuse in the local, county or state government.

In arriving at their first duty assignment, they find a community that seems to be somewhat similar to that of their hometown. The CO seems to be the mayor, and the chief master-at-arms represents the chief of police. The CO's staff fills the rest of the government positions. There are schools, stores, businesses and recreational services.

However, Navy journalists must learn that the CO is not so much a mayor as he is the president of a company. Likewise, the Navy community is really much like a company town. Your job within this community is to enhance morale, to increase readiness and productivity, to be the voice of the CO to his community, and to inform, educate and entertain the Navy's internal audience.

## **PERSONAL TRAITS**

To accomplish the assignments previously mentioned, the Navy journalist must have certain personal characteristics. Some are general characteristics that contribute to success in any rating, but others are an integral part of the public affairs profession. The characteristics of appearance, voice, military bearing, courtesy and personality will become more evident as you read this TRAMAN and complete the accompanying nonresident training course (NRTC).

## **APPEARANCE**

Good personal appearance is especially important to the Navy journalist. Most of your work will be

relatively clean in nature, so it is possible to work hard and still look neat. Since your duties place you in a position to meet visitors, escort reporters, interview VIPs, act as a tour guide, and so forth, good appearance is more necessary than in some other jobs in the Navy. Always make sure every aspect of your personal appearance, from your haircut to the edge dressing on your shoes, is first-rate.

## **VOICE**

Voice and manner of speaking are important. You should avoid an overly loud voice, but likewise, you should avoid speaking too low or indistinctly. Localisms of vocabulary or accent maybe merely pleasant marks of individuality, or they maybe hindrances because they make the speaker hard to understand. If you have conspicuous speech habits of this sort, you should attempt to correct them. Your attention to pronunciation of words will always be worthwhile.

## **MILITARY BEARING**

All petty officers have an obligation to conduct themselves with dignity and in such a manner as to reflect credit on the naval service. Dignity exists only where the individual has a proper sense of his own worth and of the worthiness of his cause. The person who possesses true dignity also will respect the dignity of others.

Military bearing is dignity within military relationships. It exists when the individual is proud of his military organization and of his part in it. He respects his seniors and is guided by the example of those he admires most among them. He tilso respects his juniors and tries to provide an example they will be proud to follow. Whether he is squaring his hat, rendering a salute, carrying on the work of his office, or going on liberty, his manner says that he is proud of the Navy and is doing his best to make the Navy proud of him.

## **COURTESY**

The qualifications for advancement do not list courtesy as a requirement, but they imply it. Most situations require a certain minimum standard in terms of manners, and unless we display this standard, we are in trouble. Courtesy goes far beyond that. It is in fact totally different in character, because courtesy comes from within and is a voluntary expression of respect for the rights and feelings of others. How your job as a journalist involves your interaction with others is emphasized throughout this TRAMAN. More than any

other rating in the Navy, you will be associated primarily with people in the civilian populace. Courtesy on your part will smooth the way not only for you, but for your command, your seniors and the people who work for you.

## **PERSONALITY**

A pleasing personality is a must in the journalist rating. You must be able to get along with your shipmates, because their cooperation is necessary before you can carry out your duties. Always strive to establish a good name for the JO community. When you have the confidence of your shipmates, your job will be 100 percent easier.

## **NAVY ENLISTED CLASSIFICATIONS**

Navy Enlisted Classifications (NECs) are four-digit numbers that indicate special qualifications earned by an individual. Currently, there are four NECs available to Navy journalists, as described in the following text.

### **JO-3221 — BROADCAST OPERATIONS SPECIALIST**

The holder of a 3221 NEC originates, prepares and broadcasts command information for use on radio, television, satellite or Shipboard Information, Training and Entertainment (SITE) systems. Additionally, he acts as a researcher, writer, interviewer, narrator, broadcast equipment operator, program scheduler and director.

If you desire this NEC, you must complete the Basic Broadcaster Course (BBC) at the Defense Media Institute (DMI), formerly the Defense Information School (DINFOS). You also may earn the classification by logging one year of documented experience at an NBS detachment or AFRTS outlet or on a SITE-equipped ship. If you have equivalent civilian experience, you may request a waiver of the one year experience requirement.

### **JO-3251 — BROADCAST OPERATIONS DIRECTOR**

Individuals with this NEC direct the operations of radio, television, satellite, cable and SITE support systems as coordinated elements of the command information broadcasting function. Other key tasks include conducting research and planning programming, production, budgeting, training and maintenance.

This NEC could be part of your long-range career planning. You may earn it by graduating from the Broadcast Managers Course (BMC) at the DMI or by completing at least two previous management assignments with AFRTS activities.

### **PH-8147— PHOTOJOURNALISM SPECIALIST**

Although this is primarily a photographer's mate NEC, members of the JO rating also may earn it. Sailors with this NEC cover and photograph events of news or documentary interest, while supporting and effectively meeting the public affairs objectives and programs of the military services. They apply layout and design principles, news and feature writing, basic and advanced photographic techniques and production, and demonstrate writing and photographic skills.

To earn this NEC, you must first complete the eight-week Intermediate Photojournalism Course (IPC) offered at the DMI (JO "B" School), then perform as a photojournalist in the field for one year. Your CO must forward an endorsement to the DMI before the NEC is approved and awarded

### **PH-8148— PHOTOJOURNALIST**

Sailors with the PH-8148 NEC photograph newsworthy events, prepare photography in news form, write captions and text for news stories, and maintain liaison with their counterparts in the news media. They also train personnel in photojournalism techniques.

You can earn this NEC by applying for acceptance to PH/JO "C" School at the Rochester Institute of Technology. This fully accredited curriculum includes a minimum of 18 semester hours (30 quarter hours) of advanced photojournalism techniques and practices, including picture editing, newswriting and reporting, feature article writing, graphic arts, layouts, design, ethics in journalism, and many others. The NEC is awarded after your successful completion of the course.

You may obtain further information on all four NECs by consulting the *Manual of Navy Enlisted Manpower and Personnel Classifications and Occupational Standards, Volume II (Navy Enlisted Classifications)*, NAVPERS 18068F.

### **TRAMAN PURPOSE**

The purpose of this TRAMAN is ensure the quality and integrity of Navy journalist training and to help you meet the basic requirements for advancement to J03 and J02. It is based on the most current (at the time of this writing) journalist occupational standards (OCCSTDS) in the *Advancement Handbook for Petty Officers (JO)*. Since OCCSTDS change periodically, be sure you check with your Educational Services Office (ESO) for the most up-to-date OCCSTDS.

This TRAMAN will not make you an accomplished writer or a public affairs specialist overnight, but it can help. It contains many useful rules and tips that, if you learn and practice, will lead you down the path of success in one of the most exciting and rewarding ratings in the U.S. Navy.



## CHAPTER 2

# BASIC NEWSWRITING

What elements make a news story and how are they used to construct a story?

If you were to pose these questions to a group of reporters, it is probable that no two of them would give the same responses. However, all would most likely include in their answers a similar list of elements they consider necessary for a story to be newsworthy.

This chapter will include this “list” of sorts and other essentials that will help you be successful in writing the basic news story.

### BASIC ELEMENTS OF A NEWS STORY

*LEARNING OBJECTIVE: Identify the basic elements of a news story.*

For the purposes of this TRAMAN, we will use the following 10 categories as those covering the major elements of news:

- Immediacy
- Proximity
- Consequence
- Conflict
- Oddity
- Sex
- Emotion
- Prominence
- Suspense
- Progress

If any one of these elements is present, a story has news value, but many stories contain more than one element. Remember this latter fact as you study the material that follows because even though the 10 elements are used as the framework of this discussion, several of the examples given might just as well be discussed under different elements.

Remember, too, that this is just one possible classification; another textbook might have classified

these elements in slightly different categories. Rather than memorizing a set of categories, your chief concern will be to develop your understanding of what constitutes an interesting news story.

### IMMEDIACY

A story that has just happened is news; one that happened a few days ago is history. Immediacy is timeliness. Few events of major significance can stand up as news if they fail to meet the test of timeliness. There is no point in submitting a news release on a routine change of command that occurred four days ago; the event is not big enough to overcome the time lag. A newspaper looks foolish if it publishes a news story, and after reading it, a subscriber says, “I heard about that two days ago.”

However, an event that occurred sometime ago may still be timely if it has just been revealed. Examples are a newly discovered diary of John Paul Jones or the disclosure of a startling scientific accomplishment that occurred months ago, but has just been declassified. In these cases, the immediacy element revolves around the fact that the news was revealed or disclosed today. An up-to-the-minute touch is provided by words such as “newly disclosed,” “revealed,” “divulged” or “announced today.”

### PROXIMITY

Readers are interested in what happens close to them. Proximity is the nearness of an event to the readers or listeners and how closely it touches their lives. People are interested mainly in themselves, their families, their ships or stations, their friends and their home towns. If Capt. Gunn relieves Capt. Stone as commanding officer of Naval Station Annapolis, it is news in the Annapolis, Baltimore and Washington areas and in the two officers’ home towns. It is not news in Huntsville, Ala., where no one knows either captain or cares particularly who commands a naval station in Maryland. Improvement or progress stories are important in their degree of proximity.

The Navy’s home town news program is based on this element. When Thomas Katt, Seaman Apprentice, USN, reports to USS *Pine*, it is news for his hometown

paper. Back home in Hialeah, Fla., he is not Navy Seaman Apprentice Thomas Katt. He is Mr. Michael Katt's son, Thomas, who used to help his father rebuild homes devastated by Hurricane Andrew. He is someone the readers know. The element of proximity is present to a high degree. Further information on home town news may be found in Chapter 17.

## **CONSEQUENCE**

News of change or news that affects human relations is news of consequence. The more people affected, the greater the news value. A story on the advancement of 1,500 petty officers has consequence within the Navy, especially to those who took the exams. A congressional act that raises the pay of everyone in the armed forces is of great consequence both to the Navy and to the public, which foots the bill and also benefits from the increased purchasing power of the serviceman or servicewoman.

## **CONFLICT**

Sporting events, wars and revolutions are the most common examples of conflict in the news. Man maybe pitted against man, team against team, nation against nation or man against the natural elements. A story about a pilot struggling to land a crippled plane or a coxswain's heroic efforts to keep his crowded boat from swamping in heavy seas are other examples.

## **ODDITY**

The unusual or strange will help lift a story out of the ordinary. If an ordinary pilot parachuted out of an ordinary plane with an ordinary parachute and makes an ordinary landing, there is no real news value. However, if the aviator has only one leg, this is news; or if the parachute fails to open and the pilot lands safely, this is news. A sailor named B. A. Sailor is a good angle. So is the helicopter that towed a ship, the man that bit his dog or the plane that landed even though the pilot had bailed out.

## **SEX**

Sometimes sex is the biggest single element in news, or at least it appears to be the element that attracts readers the most. Consider all the stories in papers that involve men and women — sports, financial news, society and crime. Sex, in discussing news elements, covers far more than a Hollywood star's impending visit to your command. The element of sex ranges from

front-page sensationalism to news involving engagements and marriages.

Stories and accompanying pictures of movie stars or other prominent celebrities visiting your ship or station can be loaded with sex. Nevertheless, any type of news that overemphasizes the "cheesecake" element is considered to be in poor taste for an official Navy release and is to be avoided.

## **EMOTION**

The emotional element, sometimes called the human interest element, covers all the feelings that human beings have, including happiness, sadness, anger, sympathy, ambition, hate, love, envy, generosity and humor. Emotion is comedy; emotion is tragedy; it is the interest man has in mankind. A good human interest story can range from a real "tearjerker" to a rollicking farce.

## **PROMINENCE**

Prominence is a one-word way of saying "names make news." When a person is prominent, like the President of the United States, almost anything he does is newsworthy — even his church attendance. Several hundred civilians may visit your ship or station in the course of a month without raising a stir. Yet, if one happens to be the governor of the state, you have a news story packed with prominence. Prominence is not restricted or reserved for VIPS only. Some places, things and events have prominence. For example, the White House (a place), the Hope Diamond (a thing) and Christmas (an event) all awaken interest.

## **SUSPENSE**

You most often see the suspense element in a day-by-day or hour-by-hour account of a desperate search for a lost submarine, in a story of rescue operations in a mine where workers are trapped or in the efforts made to rescue a Navy diver trapped in the wreckage of a sunken ship. A news story does not build to a climax as a mystery does. Still, putting the most important facts first does not destroy the suspense of many stories because the ultimate outcome is unknown and is usually revealed in progressive, periodic installments.

## **PROGRESS**

In our technologically advanced society, we are interested in space exploration. Therefore,

developments of more powerful and advanced rockets to propel manned space flights are of great interest to most Americans.

Progress does not have to be dramatic. For example, an improvement in mooring lines, shoe leather or paper clips can be significant progress. There is a great deal of progress in Navy news stories. The Navy is constantly making progress in seamanship, weapons systems, aeronautics, nuclear propulsion, medicine, habitability, education, human relations, leadership and other fields.

## IDENTIFICATION OF DOMINANT NEWS ELEMENTS

*LEARNING OBJECTIVE: Distinguish the dominant news elements in basic news stories.*

Just how are these key elements applied in judging the newsworthiness of an event? .

First of all, the newsworthiness of a story depends on the strength or intensity of the news elements it contains — the more intense the elements, the more newsworthy the story.

After gathering material for a news story, you normally find that one or more elements overshadow the others in intensity. These are the **dominant elements**. This is sometimes referred to as the **news peg**.

### NEWS PEG

A news peg is the most significant or interesting fact in a story. It is featured in the first paragraph, and all other facts revolve around it. In other words, it is a foundation around which you construct the facts of your story.

For just a few moments, put yourself in this hypothetical situation and assume that you are a JO assigned to the Public Affairs Office, NAS Moffett Field, Calif. The facts of the story, for which you have been given the task of readying for a 1400 release to the local media, are as follows:

1. Navy Lt. Humberto K. Libute, son of Mr. and Mrs. Perfecto F. Libute of 2714 Caspian St., Long Beach, Calif., is a pilot attached to Fighter Squadron 24 at NAS Miramar.

2. At 9 am. (always use civilian terminology for civilian media), Lt. Libute took off from the naval air station in a supersonic F-14 "Tomcat" for gunnery practice over the Mojave Desert.

3. At 9:20 a.m., while flying at an altitude of 13,000 feet, Lt. Libute put his plane into a shallow dive and fired a few bursts from his cannon. When he pulled out of the dive a few seconds later, hydraulic warning lights lighted up like a Christmas tree.

4. Lt. Libute fought desperately to control his damaged plane, but had to bail out.

5. Amazingly the Tomcat landed in the desert. The plane's wings sheared off causing considerable damage, but the pilot escaped serious injury. He walked away from the crash, but collapsed from shock and loss of blood.

6. After an emergency blood transfusion and treatment for shock, Lt. Libute is recovering at the NAS hospital. Doctors report that his condition is good.

7. A preliminary investigation into the cause of the accident revealed that Lt. Libute's jet had lost hydraulic pressure.

Now that we know the facts in the story, let us see if we can determine the most dominant elements. Figure 2-1 will help you analyze them. Elements have been classified in degrees of **very strong, strong, weak, very weak and none**.

As you can see, the elements of immediacy, proximity and oddity are listed as strong. They are dominant elements in this story, with oddity taking a decided edge over the other two. They will be combined in the news peg, which will be featured in the beginning of the story. The news peg for this story could be written as follows:

"A Navy plane was shot down by its own gunfire near San Jose today. The plane, piloted by Lt. Humberto K.Libute..."

As the story is developed, the other facts are introduced to complement or supplement the dominant elements featured in the news peg.

Figure 2-2 lists a few other examples of analyzing dominant elements for the news peg. The first element listed is the strongest. The others, if there are any, are supporting elements.

Note that immediacy and proximity are not listed as dominant elements, unless they actually overshadow the other elements. Immediacy is present in practically every story because the facts must be **new** to be considered news. Proximity also is present impractically every local story.

News Element	Degree of Intensity	Justification
Immediacy	Strong	Accident occurred this morning. Story will be released this afternoon.
Proximity	Strong	Accident occurred locally. Squadron and pilot are attached locally.
Consequence	Weak	Measures will undoubtedly be taken to prevent further recurrence of this type, but this one incident in itself does not affect a great number of people.
Conflict	Weak	The pilot's struggle for survival is worth mentioning, but more details are necessary to make this element strong.
Oddity	Very Strong	Nothing like this has been recorded before.
Sex	None	-----
Emotion	Very Weak	The reader will sympathize with the pilot, but not beyond the extent one human being sympathizes for another human being in an unfortunate situation.
Prominence	None	The pilot is not widely known.
Suspense	Weak	Although the facts, as presented here, do not lend themselves to suspended interest, the story has a certain amount of drama and suspense.
Progress	Weak	Progress in aviation may eventually result from this situation, but there is nothing in the facts that will improve mankind's health, comfort or happiness.

Figure 2-1.—Analyzing news elements.

## SPOT AND CREATED NEWS

Most Navy news (and all other news as well) can be classified as either **spot news** or **created news**.

**Spot news** just happens. A ship runs aground. A plane crashes. A heroic rescue takes place in a storm-tossed sea. These are just a few examples. Your job is to provide a full account of a spot news story as soon as possible — even in cases where the general effect is unfavorable to the Navy.

**Created news** is generally concerned with something the Navy has done or plans to do which the public should know about. Examples include air shows, command public visitation, change of command, unveiling new ships, planes or weapons, construction programs, special achievements, ship arrivals and many of the other daily events of Navy life. Your job is to bring

the information to the attention of news media, usually through a Navy news release.

## CLASSES OF NEWS STORIES

Most Navy news stories fall into four main categories—hard news, feature, sports and social. They are described in the following text.

### Hard News

The hard news story is designed primarily to inform. It usually concerns a news item involving or affecting the readers, listeners or viewers. The hard news story has usually taken place since a previous issue of a newspaper or a radio or television newscast. Much of the material found in daily papers (especially front-page items) or newscasts are in the hard news category.

News Item	Dominant Element
Today is the final day for filing your annual income tax return.	Immediacy Consequence
A Navy flier, who braved enemy ground fire to locate a downed fellow airman over hostile territory, has been posthumously presented the Navy Cross.	Emotion
The Administration is near a final decision — perhaps it will come next week — on how much of a pay raise it will seek for the armed forces.	Consequence
The President of the United States submitted the names of 50 flag rank selectees to the senate for confirmation, including the name of Capt. Alene B. Drucek. Capt. Drucek, a Nurse Corps selectee, will be the Navy's first woman flag officer.	Prominence Sex
Seaman Floyd M. Pirtle, son of Mr. and Mrs. Floyd Pirtle of Route 2, Fayetteville, Tenn., is currently patrolling the Western Pacific with the Seventh Fleet aboard the aircraft carrier USS <i>Kitty Hawk</i> .	Proximity (in the Fayetteville area)
A Navy officer, who had never taken control of an aircraft, brought an Air Force spotter plane in for a rough but successful landing recently. The incident came about after the pilot was killed by ground fire during a routine observation mission over enemy territory.	Oddity Suspense
More new weapons systems than before, an improved retention rate, better housing, and an increase in minority recruiting were some of the accomplishments that John H. Chafee was proud to list from his 3 1/2 years as Secretary of the Navy.	Progress Prominence
Navy sank Delaware, 24-3 today in the first ever Blue Crab Bowl at Navy-Marine Corps Memorial Stadium.	Conflict
The first female seaman qualified today as a deep sea diver at the Navy Diving and Salvage School.	Sex Oddity

Figure 2-2.—Identifying dominant news elements.

### Feature News

The feature news story is about an event or situation that stirs the emotions or imagination. The event may or may not have taken place, or the situation may or may not have arisen since the last issue of a periodical or delivery of a newscast. The feature story is designed primarily to entertain, but it also serves to create interest or to inform the reader. It may be about such subjects as a sailor with the unusual hobby of collecting 18th-century etchings, a command that has adopted a stray goat as a mascot, a Navy cook who worked in a leading French restaurant before enlisting or, in a serious vein, the plight of a child who has been orphaned by an automobile accident.

### Sports News

The sports news story may be handled as either hard news or a feature. These stories chronicle the activities

accomplishments of sports figures. In most cases of Navy sports, unless teams are prominent (such as that of the U.S. Naval Academy), the material is aimed at ship and station publications.

### Social News

The social story, which may also be handled as either hard news or as a feature, primarily concerns wives; daughters and family activities. Most often Navy social stories deal with the activities of officers and enlisted wives' clubs, the happenings of the teen-age set, weddings and local charity events.

### Other Categories

Other categories of stories frequently used in metropolitan newspapers include interpretive, science, consumer and financial.

**INTERPRETIVE.**— In an interpretive story, the reporter attempts to give an in-depth analysis and survey of the causes or possible consequences of important news events.

**SCIENCE.**— With this story, the reporter attempts to explain, in layman’s language, scientific and technological news.

**CONSUMER.**— The writer of a consumer story attempts to help his audience buy more wisely, maintain products and homes better, cook or garden better, and so forth.

**FINANCIAL.**— Writers of financial news focus on business, commercial or investment stories.

Writers of these stories are usually expected to have an academic background or experience in their subject matter, as well as the ability to observe and write well.

## **NEWS STYLE VS. LITERARY ENGLISH**

*LEARNING OBJECTIVE: Recognize the differences between the news and literary English writing styles; identify the ABCs of journalism.*

Many great writers have been known for their dramatic styles, vivid descriptions and the eloquent conversation of their characters. It is obvious, however, that these great writers were not concerned with news style writing or the fundamentals of newswriting. Consider the following quotation for example:

“It is a thing well known to both American and English whalers, and as well . a thing placed upon authoritative record years ago by Scoresby, that some whales have been captured far north in the Pacific, in whose bodies have been found the barbs of harpoons darted in the Greenland seas. Nor is it to be gainsaid, that in some of these instances two assaults could not have exceeded very many days. Hence, the inference, it has been believed by some whalers, that the North West Passage, so long a problem to men, was never a problem to the whale.”

Perhaps this quotation is familiar to you. It is from *Moby Dick*, which is one of the greatest sea stories ever written. It was published more than 100 years ago and

is still read today. Its author, Herman Melville, was known for his moving literary style.

A modern journalist writing this piece for a newspaper might put it on paper as follows:

“The Northwest Passage, long sought by man, maybe known and used by whales.

“American and British sailors have reported finding the barbs of harpoons from Greenland in the bodies of whales killed in the North Pacific. In some cases, the wounds were only a few days old. This has led some whalers to believe that whales must use some shortcut from the North Atlantic to the North Pacific.”

The preceding contrast shows the difference between literary writing of more than 100 years ago and newspaper English today.

Media writing is geared to the public, not the professor. The purpose is to inform, not to impress. All the frills are stripped away. Unnecessary wording costs the media money in terms of time (electronic) or space (print).

Newspapers are read in a hurry. They are read at breakfast, on the subway, against the blare of radio or television, or over someone’s shoulder. Many readers scan the headlines and read only the opening paragraphs of a few articles. These readers have neither the time nor the desire to wade through literary writing. Many may have limited educations. Surveys show that the average newspaper reader has the reading ability of a 12-year-old child.

Does this mean that you have to write for 12-year-olds? No, it does not. We are not speaking of the readers’ ability to grasp ideas, but rather of their ability to understand difficult words. There is a great difference. For example, consider the following paragraph:

Gravitation is omnipresent; it is exerted by every body on every other body, no matter how remote or minute. Between two given objects, its force varies directly with the product of the two masses and inversely with the squares of the distance between their centers. Exerting itself throughout the

universe, it is gravitation that keeps the cosmos in equilibrium.

This paragraph is obviously too difficult for an adult with a 12-year-old reading level. Yet the adult mind could grasp the idea involved if we translate the paragraph into simple English such as follows:

All bodies attract each other. This is true no matter how small or far apart they may be. The heavier two objects are, the more they pull on each other. The farther apart they are, the weaker this force becomes. In measuring the pull, distance is particularly important, for if you double the distance, the force is cut to one-fourth of its former strength. This force is called gravitation. Because of it, the earth, sun, moon and stars all pull against each other. The forces balance, and everything stays in its proper place.

Almost any idea, no matter how complicated, can be expressed in simple language. As a Navy journalist, you may have to explain some fairly technical ideas to readers who are not familiar with military life. You will have to do it in language they will understand. It is up to you to do the work of simplification, **not your readers**. If they find your writing is over their heads, they will skip your piece and go on to something that is easier to read. If this happens, you are not doing your job.

Also remember — the story you write for the general news media will probably be read by someone with a Ph.D. How do you satisfy both? A good writer can present the information so that the less educated can understand and so that the more intelligent will not become bored.

## **THE ABCs OF JOURNALISM**

Some principles of newswriting you must apply every time you attempt to put words on paper include accuracy, brevity, clarity, coherence, emphasis, objectivity and unity.

### **ACCURACY**

If a writer has to pick one principle that should never be violated, this should be the one. To fall down in this area is to discredit your entire writing effort. As a JO, you will be working with facts. These facts will involve persons, places and things. They will involve names,

ages, titles, rank or ratings, addresses and descriptions. You will work with facts that are both familiar and unfamiliar to you.

You cannot afford to be casual in your approach to facts. Your readers will often judge the Navy on what you say and how you say it. An easy way to lose the public's respect and confidence is by being careless in your handling of facts. When you send a story to a newspaper, the editor depends on you for accuracy in every fact.

The Navy news release heading that appears on every story you distribute means the information it contains is reliable and has been approved officially by the Navy. A mistake in a news story implies that the Navy is careless and undependable. Datelines tell when and where the story is written and should appear on all stories written for release. In the text of the story, when and where may refer to the dateline.

**Attribution** relates to accuracy. It means that you name the person who makes any statement that may be challenged. Good quotations liven a story, give it color and aid in development of coherence. Attribution also ensures that the reader does not get the impression the statement is the writer's personal opinion. However, attribution should never be used in a story merely to flatter a person by publicizing his or her name.

### **BREVITY**

The question is often asked, "Should I be brief in my writing or complete?" By all means, be brief, but not at the expense of completeness. The key is to boil down your writing and eliminate garbage. A compact piece of writing is frequently much stronger than a lengthy story. An example is Lincoln's Gettysburg Address. This speech has outlived a flock of long harangues by later statesmen. One of the reasons for its survival is its brevity.

### **CLARITY**

Nothing is more discouraging than reading an article and then realizing that you do not know what you read. A similar frustration arises when you are trying to follow directions on assembling a toy, particularly when the instructions read, "...even a 5-year-old can assemble this toy," and you cannot do it, because the directions read as if they were written in a foreign language. Assume that if there is any chance of misunderstanding, readers will misunderstand. Reread what you have written looking for points that could lead to readers' misunderstanding.

## COHERENCE

An article that skips illogically from topic to topic and back again in a jumbled, befuddled manner lacks coherence. Coherence means sticking together, and that is what stories and articles should do. Facts should follow facts in some kind of reasonable order. It may be logical order, chronological order, place order or order of importance, depending on the subject, but order of one kind or another is vital. Outlining will often help.

## EMPHASIS

Make sure your writing emphasizes what you want it to. You assure this in newswriting by putting the most important fact first (the lead, discussed later). There are other types of arrangements for emphasis that are used in feature stories or in editorials. More information will be presented on this later in this chapter.

## OBJECTIVITY

To report news accurately, you must keep yourself detached from the happenings and present an impersonal, unbiased, unprejudiced story. This is why you never see a good reporter at an accident running around saying, “Isn’t this horrible? I feel so sorry for the family. Why, just the other day I was talking to ol’ Jed, and now he is dead.” These may very well be your feelings, but you must attempt to keep aloof in order to give an objective report. It is not your job to influence people directly, but rather to tell them what is going on. You direct their thinking only to the limited extent that you make them think for themselves by an unbiased presentation of the facts.

## UNITY

A news story should deal with one basic topic. There may be many facts and ins and outs to the story, but it is still one story. If you set out to write a story on the services and activities available at the enlisted club, and end up with a biography of the club manager, the story lacks unity. The simple solution frequently is to write two stories, rather than trying to combine a mass of information into one.

## THE LANGUAGE OF NEWSWRITING

Written language is made up of three elements — **words, sentences** and **paragraphs**. It is the way these elements are handled that makes the difference between

literary and news English. Briefly, let us look at these elements separately.

### Words

Words are your basic tools. Like any skilled technician, you should be able to select the best tools to do the best job. This means you should use words that say exactly what you mean so they can be understood by others.

Every word used in a news story should add to the picture you are building in the minds of your readers. If you use an unnecessary, vague or unfamiliar word, this picture becomes blurred. If it becomes too blurred, it may give the reader a distorted picture of the facts. This is a form of inaccuracy that is just as bad as putting the wrong facts down on paper.

It is an axiom of newswriting that words that do not work for you, work against you. Here are a few tips on making words work for you.

**AVOID GOBBLEDYGOOK.**— Gobbledygook is confusing writing, often marked by pseudotechnical language that readers cannot understand. In writing a technical story, do not parrot the words some technical-minded researcher pours out. **Simplify.** Ask, “What does this mean in everyday English?” Few people, for example, know what “arteriosclerosis” means. But when you say “hardening of the arteries,” they immediately understand.

**AVOID WORDINESS.**— Many inexperienced writers put unnecessary words into their news copy. Call a spade a spade, not “a long-handled agricultural implement utilized for the purpose of dislodging the earth’s crust.”

Short, common words are easy to understand when, in many cases, long words are not. If you must use a longer word, make sure you are using it to convey a special meaning, not just for the sake of using a big word. Why use **contribute** if **give** means the same thing? This also applies to **veracity** for **truth**, **monumental** for **big**, **apprehension** for **fear**, **canine** for **dog** and countless others. Practically every part of speech contains long words that may be replaced by shorter and more exact ones. The same principle applies to phrases. Why say “afforded an opportunity” when “flowed” is more exact, or why use “due to the fact that” instead of “because”?

**BE SPECIFIC.**— Inexactness is just as bad as wordiness. Readers want to know specific facts. Consider the following example of this:



**Vague:** Thousands of fans were turned away that afternoon.

**Specific:** Three thousand fans were turned away before game time.

**AVOID TRITE OR HACKNEYED EXPRESSIONS.**— These are the mark of either an amateur or a lazy writer. Some particularly bad examples include the following:

- Cheap as dirt
- Smart as a whip
- Fat as a pig
- Nipped in the bud
- Good as gold
- Blushing bride
- Grim reaper
- Wee hours
- Ripe old age
- Picture of health
- Crystal clear
- Quick as lightning
- Bouncing baby boy/girl

**USE STRONG, ACTIVE VERBS.**— Whenever possible, use active voice and the simple past tense. The use of these injects life, action and movement into your news stories. In using strong verbs, you will find some of the tendency for you to rely on adverbs to do the work is eliminated. In newswriting, adverbs often do nothing more than clutter writing. Consider the following example:

**Weak** (passive voice): The visitors were warmly received by Capt. Smith in his office.

**Stronger** (active voice): Capt. Smith greeted the visitors in his office.

**AVOID MILITARY JARGON.**— For those in the Navy, the phrase “general quarters” is clear enough. Yet for others, the phrase may mean nothing; to some, it may seem to mean the area where the general is housed. When you assume that all your readers know general quarters means the command to man battle stations for crew members aboard ship, you make a false assumption. You do not impress your readers by using

words and phrases they do not understand; you only imitate them.

For example, an unidentified Navy official issued a statement explaining that the purpose of an overtime policy was “...to accommodate needs for overtime which are identified as a result of the initiation of the procedures contained herein during the period of time necessary to institute alternative procedures to meet the identified need.”

In some situations, it is appropriate to use common military phrases, such as “fleet training exercise,” “ship’s galley” and “weapons system.”

**WATCH SPELLING AND GRAMMAR.**— A JO, or a person interested in becoming a Navy journalist, should have better than average spelling ability. This person should also have a good command of the English language as far as correct grammar is concerned. Therefore, no extensive lesson is given in this area of study, although some basics are presented in Chapter 6.

One goal of every good writer is not to learn to spell perfectly, but to learn to spell well enough so that a mistake can be spotted when words are put on paper. When in doubt, use the dictionary. Dictionaries are standard stock items in the Navy, and every public affairs office should have one. (For style, usage and spelling questions not covered in *The Associated Press Stylebook and Libel Manual*, use *Webster’s New World Dictionary of the American Language, Third College Edition*.) Additionally, keep in mind that virtually all word processing software packages contain a spell check feature that you should use at every opportunity.

**USE A STYLEBOOK.**— In newswriting, the word style refers to the spelling, punctuation, capitalization, abbreviation and similar mechanical aspects of grammar used in preparing copy (a term used to describe all news manuscripts). Most newspapers and other periodicals have their own style sheets or local interpretations of style rules. The important thing for you to remember about style is **consistency**.

The recommended guide for preparing military news is *The Associated Press Stylebook and Libel Manual*. However, any locally prepared style guide or style sheet is fine as long as it is internally consistent and is suitable for your purpose. For further information on stylebooks, consult Chapter 7 (Newspaper Staff Supervision) of the JO 1 & C TRAMAN.

## Sentences

The second element of language is the sentence. The simple declarative sentence that consists of subject and verb, or subject, verb and object is the most common form in normal, informal conversation. For this reason, it is the best sentence structure for most newswriting. Notice how the following sentence becomes more readable and understandable when it is rewritten in two simple sentences:

**Sentence:** Following his graduation from the U.S. Naval Academy in 1948, Brown was assigned to the destroyer USS *Roulston*, where he served his first tour of sea duty for three years as assistant communications officer and junior watch officer.

**Rewrite:** Brown was graduated from the U.S. Naval Academy in 1948. He spent his first tour of sea duty aboard the destroyer USS *Roulston* as assistant communications officer and junior watch officer.

Simplifying sentences is not difficult, but it does take a little practice. In time, you can learn to use just the right number of words to achieve maximum clarity without destroying smoothness.

There are no absolute rules, but a fair guide is to try to keep sentences to 30 words or less and to shoot for 17 to 20. Vary the length of your sentences. For example, you might use a four-word sentence, then a 15-word sentence, then an eight-word sentence, followed by a 30-word sentence. This keeps your writing from becoming singsong.

**DO NOT CLUTTER.**— Never crowd too many details into one sentence. Although a compound or complex sentence may contain more than one thought, you should, for the most part, stick to sentences that express one thought clearly and concisely. Otherwise, the reader is apt to get lost in a mass of clauses and details.

**DO NOT REPEAT.**— If you say in the lead of your story that 61 people were killed in a training accident, do not mention later in the story that 61 were killed. If the readers forget a fact, they can look back. Newspaper space is valuable; do not waste it with redundancy. Refrain from beginning a sentence with the same word as the last word in the previous sentence and avoid beginning consecutive sentences alike, unless you do it deliberately for emphasis.

## Paragraphs

The most general guideline for writing paragraphs is that they should be kept reasonably short. When you use short paragraphs, you give the reader facts and ideas in smaller packages that are easier to handle. The mind can grasp a small unit of thought more easily than a large unit. Also, most news copy is set in narrow columns with only three to five words per line. This makes paragraphs of normal literary length appear as extremely long, unrelieved gray blocks of body type (more detail on typography, the appearance and arrangement of printed matter is contained in Chapter 8). These large gray blocks of type are monotonous to the reader's eye and difficult to read.

Paragraphs should be less than 60 words. Two or three sentences per paragraph are just about right, but it is perfectly acceptable to have a one-sentence paragraph, or even a one-word paragraph, if it expresses a complete thought.

Yet, a succession of very short paragraphs may give a choppy effect to the writing. For best effect, alternate paragraphs of short and medium length. Never begin succeeding paragraphs with the same words or phrases. This, too, can cause a monotonous effect that will soon discourage the reader.

### THE STRAIGHT NEWS STORY

*LEARNING OBJECTIVE: Outline the various parts of the straight news story.*

The major difference in style between newswriting English and literary English was discussed earlier in this chapter. There is also a big difference in structure between the literary piece and a newspaper story.

Journalism and architecture have more in common than what is evident at first glance. While the designing and planning of a building is far more complicated than the construction of a news story, both are the same in principle. In each case, space is a prime element.

An architect uses bricks, cement and other materials; a newswriter uses words as his bricks and cement. If the building lacks design and careful construction, it will collapse; if the news story is not carefully planned, it will only serve to confuse the reader and discredit the publication in which it appears.

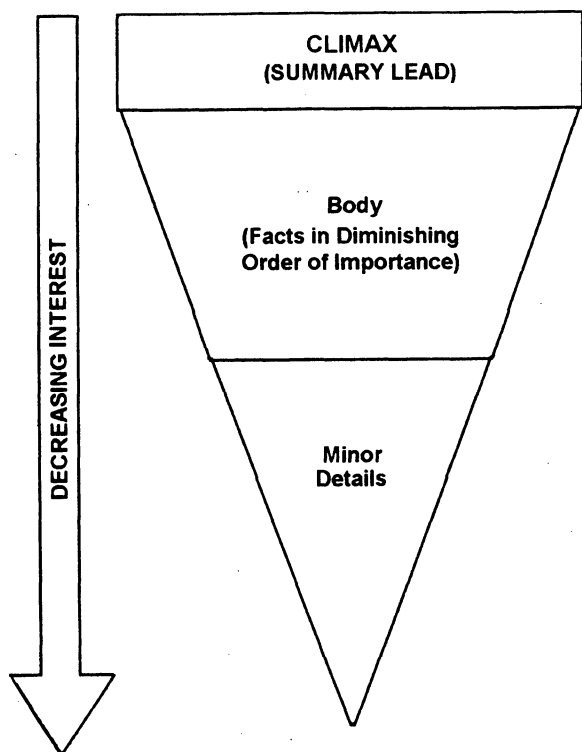

Figure 2-3.—Inverted pyramid news story structure.

Before you can present the facts, you first must understand them, appraise them correctly and organize them in an orderly and easily understood manner. This process of organization and selection begins when you set out on an assignment. You rarely will be able to get your facts in the order in which they will appear in the final story. The process of legible note-taking provides the raw material for you to construct the story, and certain proven guidelines serve as the blueprint for building the final product.

In fiction, a short story or novel is normally constructed in chronological order. This means the author starts from the beginning, sets the time and place, describes the scene, introduces his characters, then slowly weaves the threads of his plots and subplots until a climax is reached, usually near the end of the story. The writer deliberately holds back the climax to build suspense and to make sure the reader reads the entire story.

Most news stories, however, are constructed in just the opposite fashion. **The climax is presented first.** This method packs the most important facts together with the barest necessary explanatory material into the first paragraph (the summary lead), then moves into the

detailed portion of the story (the body) by covering the facts in diminishing order of importance. This form of newswriting is commonly known as the inverted pyramid style because when it is diagramed, it appears as an upside-down pyramid (fig. 2-3).

### ADVANTAGES OF THE INVERTED PYRAMID STYLE

The inverted pyramid style offers several distinct advantages in newswriting, which are discussed in the following text.

#### Presents Pertinent Facts First

Most readers have neither the time nor the desire to read every word of every story in a newspaper. By using the summary lead, the JO focuses the reader's attention on the news, arouses the reader's interest and allows the reader to swiftly skim important facts. In other words, spill the whole story in the first paragraph. The reader can decide whether to continue reading the details or to go on to something else. But even if the reader stops there, the inverted pyramid form of writing has provided the essential facts. The primary objective of a news story then, is not to withhold information, but to present the facts with rapid, simple directness.

#### Facilitates Page Layout

The inverted pyramid method of story construction is a valuable tool to the makeup person who is confronted with an eight-inch story and only six inches of column space. If the story has been written in inverted pyramid form, it becomes a simple matter of cutting lines of type from the bottom of the story until it fits the available space or "jumping" (continuing) the story on another page — all without damage to the important facts that appear at the top.

#### Facilitates Headline Writing

Headlines for news stories should tell the main facts in the most brief form. If a story is written in the proper inverted pyramid style, the copyreader (who writes the headline) can find these facts in the first paragraph. The copyreader will not have to search the entire story for headline material.

### THE LEAD

The opening paragraph of a news story is referred to as the **lead** (pronounced "leed").

Element	Example
Who	A smoke jumper extinguished a blaze and prevented a forest fire in Gallatin National Forrest, Wyo., yesterday by diverting a mountain waterfall over a burning tree.  <b>Note:</b> This is an impersonal "who" lead. The "who" can be identified in general terms when the individual or group is not well known by name, such as "three Navy admirals," "a former secretary of the Navy" or "three Navy seamen." When the impersonal "who" lead is used, the actual name or names should be mentioned further down in the story.
What	A burning tree didn't become a forest fire in Gallatin National Forest, Wyo., yesterday because a smoke jumper diverted a small mountain waterfall.
When	Yesterday a smoke jumper prevented a forest fire in Gallatin National Forest, Wyo., when he diverted a small mountain waterfall over a blazing tree.
Where	In Gallatin National Forest, Wyo., a smoke jumper yesterday prevented a forest fire by diverting a small mountain waterfall over a burning tree.
Why	To prevent a forest fire in Gallatin National Forest, Wyo., a smoke jumper yesterday diverted a small mountain waterfall over a blazing tree.
How	By diverting a small mountain waterfall over a blazing tree in Gallatin National Forest, Wyo., yesterday, a smoke jumper prevented a forest fire.

Figure 2-4.—Example lead variations.

Story Category	Summary Lead
Hometownner	<b>WHO</b> AT SEA ABOARD USS <i>KITTY HAWK</i> — Seaman John L. Slayton, USN, son of Mr. and Mrs. Robert K. Slayton of Route 3, Fayetteville, Tenn., <b>WHAT</b> reported for duty <b>WHEN</b> July 25 <b>WHERE</b> aboard the aircraft carrier USS <i>Kitty Hawk</i> .
Award Presentation	<b>WHO</b> AGANA, GUAM — A Navy petty officer <b>WHAT</b> was awarded the Navy Achievement Medal <b>WHERE</b> here <b>WHEN</b> today <b>WHY</b> for saving the life of a 5-year-old girl <b>HOW</b> by rescuing her from the shark-infested waters of Telefofo Bay.
Accident Story	<b>WHO</b> NORFOLK, VA., Jan. 7 — A Navy seaman <b>WHAT</b> was killed <b>WHEN</b> today <b>WHY</b> when his car collided with a bus <b>WHERE</b> near Wards Corner on Granby Street.
Change of Command Story	<b>WHO</b> SAN DIEGO — Capt. Winston P. Gregory, USN, <b>WHAT</b> took command of the submarine tender USS <i>McKee</i> (AS 41) <b>WHEN</b> today <b>WHERE</b> in shipboard ceremonies here at North Island.
Convention Story	<b>WHO</b> NAS ALAMEDA, CALIF. — Forty-five members of the surviving 55 famed Doolittle Raiders <b>WHERE</b> were present here <b>WHEN</b> this week <b>WHAT</b> for a three-day program which commemorated the 50th anniversary of the first American bombing raid of Japan.

Figure 2-5.—Example summary leads by story category.

	Dominant Fact	Lead Example
WHEN:	Sometimes the time element plays an important part in the story.	With only five seconds left to play, Navy scored the winning touchdown to defeat Army, 36-30 in the annual football classic this afternoon at Philadelphia.
WHERE:	If the setting of your story is unusual or especially important, play it up at the beginning.	Three hundred miles above the earth's atmosphere, two Navy astronauts are orbiting the earth in a spacecraft at speeds more than 50,000 mph.
WHAT:	When a thing or action in a story is noteworthy and overshadows the other facts, it, too, should be featured in the beginning.	Bowling two consecutive 300 games was the unprecedented accomplishment of Dick Hitchens, USN, a crew member of the submarine tender USS <i>Milano</i> .
WHY:	The motive, cause or reason may also be an important feature of the lead.	Because he was raised in an orphanage himself, a veteran Navy combat pilot is attempting to adopt two Italian children whose parents were killed in an automobile accident.
HOW:	The circumstances or the manner in which something is accomplished in a news story is often important.	By hurling a 20mm shell magazine from the destroyer USS <i>Homeboy</i> yesterday, a Navy gunner's mate prevented severe damage to his ship and possibly saved the lives of several crew members.

Figure 2-6.—Sample summary leads featuring the most important elements.

The lead is the first and most important paragraph of any news story. It attracts the reader and states the important facts first.

A key fundamental fact taught in classrooms the first time news writing is mentioned, and repeated at the college level, is that in writing a lead for a straight news story, the writer must answer six basic questions about the event. Known as the five Ws and H questions, they are as follows: **who, what, where, when, why** and **how**.

It is not necessary that a writer answer all of these questions in the lead sentence. The summary lead does, however, attempt to answer several of the more important ones. To insist upon answering the five Ws and H questions as a rigid format will lead to lengthy, cumbersome leads that may be misleading or hard to read. The lead contains the news peg and is the most important part of the story. It can either make or break any news story.

### Length

Try not to use more than 30 words in the lead, but do not make this an inviolable rule. Some leads, even when well written, may require 35 or even 40 words. On the other hand, many — or perhaps most — require fewer than 30 words to accomplish their objective.

A good lead maybe a single word, a single sentence, two sentences, a paragraph or even two paragraphs. Whatever form it takes, it must answer the questions a reader would normally ask such as the following:

“**What** has happened or is about to happen?” “**Who** is involved?” “**When** and **where** did it happen?” And, sometimes, “**how** and **why** did it happen?” An effective lead directs the reader’s interest into the body of the story.

The summary news lead is the one most often used at the beginning of a straight news story. The most direct approach (and best method for an inexperienced writer to use in constructing a summary lead) is known simply as featuring the most important element. Featuring the most important element means exactly what it says. The writer determines which of the five Ws and H is most important to the story and places it at the outset of the lead. Each of the example leads in figure 2-4 features a different W or H as the most important element.

The leads in the figure are given to show how any element may be featured. The “why” element (to prevent a forest fire in this case) is clearly understood and can be dropped out of most leads to avoid redundancy and extra wording. Other summary lead examples are presented in figure 2-5 that answers all or most of the necessary five Ws or H. Those omitted are either implied or unnecessary.

The five summary lead examples in figure 2-5 are all “who” leads. In each example, who is featured at the beginning of the lead, thus giving it more prominence than the other Ws or H. More examples of summary leads are illustrated in figure 2-6, with a different W, or H, featured at the beginning of each.

Type of Novelty Lead	Example
<p><b>CONTRAST:</b> The contrast lead compares two opposite extremes, generally to dramatize a story. The comparisons most frequently used are tragedy with comedy, age with youth, the past with the present and the beautiful with the ugly.</p>	<p>In 1914, the United States entered the First World War with a Navy of 4,376 officers, 69,680 men, 54 airplanes, one airship, three balloons and one air station.</p> <p>Today, there are more than 500,000 active-duty officers and enlisted personnel, 475 ships and 8,260 aircraft in our Navy.</p>
<p><b>PICTURE:</b> The picture lead draws a vivid word picture of the person or thing in the story. It allows the reader to see the person or thing as you saw it.</p>	<p>Thin and unshaven, his clothes drooping from his body like rags on a scarecrow, Lt. Frank Brown, USN, today told naval authorities about his six-week ordeal in an open rubber boat in the South China Sea.</p>
<p><b>FREAK:</b> The freak lead is the most novel of the novelty leads. As the name implies, the freak lead employs a play on words, alliteration, poetry or an unusual typographical arrangement to introduce the facts in the story and to attract the reader's attention.</p>	<p>For sale: One guided missile destroyer.</p> <p>The Navy is thinking about inserting this advertisement. ...</p> <p>Sammy \$mith, who i\$ ju\$t \$even, wa\$ digging in the \$and at \$am\$on\$ Beach today and gue\$\$ what he found?</p>
<p><b>BACKGROUND:</b> The background lead is similar to a picture lead, except for one important difference. It draws a vivid word picture of the news setting, surroundings or circumstances.</p>	<p>High seas, strong winds and heavy overcast provided the setting for a dramatic mission of mercy in the North Atlantic on the first day of the new year.</p>
<p><b>PUNCH:</b> The punch lead consists of a blunt, explosive statement designed to surprise or jolt the reader.</p>	<p>The president is dead. Friday the 13th is over, but the casualty list is still growing.</p>
<p><b>QUESTION:</b> The question lead features a pertinent query that arouses the readers' curiosity and makes them want to read the body of the story for answers. Phrase this lead as a rhetorical question (a question that cannot be answered with a straight "yes" or "no").</p>	<p>How does pay in the Navy compare with civilian wages?</p> <p>Has the space age affected the role of the Navy?</p>
<p><b>QUOTATION:</b> The quotation lead features a short, eye-catching quote or remark, usually set in quotation marks. A quote lead should be used only when it is so important or remarkable that it overshadows the other facts in the story.</p>	<p>"You really don't know what freedom is until you have had to escape from Communist captivity," says Bob Dengler, a former Navy lieutenant and an escapee from a Viet Cong prison camp.</p>
<p><b>DIRECT ADDRESS</b> The direct address lead is aimed directly at the readers and makes them collaborators with facts in the story. It usually employs the pronouns "you" and "your."</p>	<p>Your pay will increase by 10 percent next month.</p> <p>You can receive a college education at Navy expense if you qualify under a new program announced this week.</p>

Figure 2-7.—Sample novelty leads.

## Feature and Novelty Leads

Although the summary lead is the simplest, safest and strongest of all leads used in straight newswriting, most media like to add a little variety when leading into a story. Feature leads are a vital part of newspaper writing. The feature lead permits you to take a mundane straight news piece and transform it into a story that captures the interest and empathy of the readers.

Novelty leads differ from summary leads in that they make no attempt to answer all of the five Ws and the H. As the name implies, novelty leads are novel. They use different writing approaches to present different news situations to attract the reader's attention and arouse curiosity.

Feature leads must fit the mood of the story. If you intend to set a particular mood or point of view in a story, your intent or tone should be set at the beginning of the story.

If the situation presents itself in which a novelty lead would be appropriate, by all means use it. Do not get into the habit, however, of trying to write a novelty lead for every story, because they are not always adaptable to every situation. It is easy for the unusual to become commonplace if it is seen or heard too often. Novelty leads lose their effect if they are overused.

Figure 2-7 presents various examples of novelty leads most commonly used in newswriting. Although the eight types described are the ones most commonly used, it is a mistake for you to assume that all news leads may be categorized by type or classification. Their names are not important anyway. To the JO, the ability to write is more important than the ability to categorize.

## Identity and Authority

There are two other considerations to keep in mind when you are preparing news leads — **identity** and **authority**. In most local stories, especially homeowners, it is necessary to identify persons frilly in the lead.

For example, suppose you prepared a hometown story on a sailor who formerly resided in Louisville, Ky. Not being very experienced, you turn in a lead like the following:

“Navy Seaman Eugene M. Brainer reported for duty Feb. 16 aboard the guided-missile cruiser USS *Hinkle*, now operating in Western Pacific waters.”

Although you have answered all the Ws and H except why and how (in this case unnecessary), your lead is still incomplete. The story is meaningless until you identify Brainer as being from Louisville. Even then, an editor of a Louisville newspaper will want a local angle on the sailor. The only angle available to you is the name of Brainer's parents and their home address.

You must, therefore, identify Brainer more fully in your lead. It is unlikely that many of the newspaper's readers would know him merely by name, and a city the size of Louisville might have more than one Eugene M. Brainer. To localize the story and to avoid confusion or misinterpretation, you would include more identification. The lead should be written in the following way:

“A Kentucky native, Seaman Eugene M. Brainer, son of Mr. and Mrs. Mack Brainer of 70 N. Williams St., Louisville, reported for duty Feb. 16 aboard the guided-missile cruiser USS *Hinkle*, a unit of the Navy's Seventh Fleet in the Pacific”

As you can see, complete identification of a person in the lead sometimes makes that lead long and cumbersome. Yet, it cannot be avoided in hometown stories where identity is more important than the action, especially if the action is weak, as it is in the preceding example.

In many instances, however, full identification is unnecessary or impractical for inclusion in the lead. In general, complete lead identification is unnecessary and should be avoided when one or more of the following points is true:

- The action overshadows the person or persons involved.
- There are too many persons involved to identify all of them by name and rate.
- The identification does not mean much to the readers in a particular area.
- The “who” is a prominent, widely known figure.

When an individual is not fully identified in the lead, that person must be identified by name, rank or rating, title, duty station and possibly hometown address elsewhere in the story. This identification is also important for places and things in a story. If you use the name of an unfamiliar town or city in a story, at least identify it by the state in which it is located. If you use

the name of a ship or an airplane, give its type or classification.

Impersonal identification may be used in the lead when the news subject consists of several persons unfamiliar to the reader, such as groups or organizations. Nonspecific whats, wheres and whens may also be used depending on the news circumstances.

**Authority** is the source from which quotes and information originate in a story. Like identity, it should be used in the lead only when necessary. Never use authority in a story when the source of information is clearly implied.

The following is an example of a lead in which authority is necessary:

Longer tours, fewer, shorter and less expensive moves can all be expected by Navy people for the rest of this fiscal year, according to Vice Adm. David Bagley, Chief of Naval Personnel.

Attributing this statement to the Chief of Naval Personnel gives it authority, because the admiral is in a position to know and speak about such matters.

Contrary to popular belief, people do not believe “everything” they read in newspapers. Many of them, as a matter of fact, challenge any statement that conflicts with their preconceived opinions. Using authority in a story helps you overcome this natural skepticism. Sometimes people will believe certain facts more readily if they know or respect the person to whom they are attributed.

What follows are two simple rules governing the use of authority in a news story:

- Use it when it appears that the reader may challenge a statement.
- Use it when the name of the authority lends support or emphasis to the facts.

In the Navy, the authority for many statements is frequently implied. If a story obviously deals with Navy ships, Navy personnel or Navy equipment, it is often unnecessary to use “The Navy announced today” or similar expressions. If a newspaper editor feels a statement must be attributed to the Navy, the editor will insert the authoritative source. It is a bad practice for this phrase to be inserted in every story merely for the sake of using it or just to get the word “Navy” into the story. It is also particularly bad for every news release to be attributed to the captain or admiral by name, especially when the subject of the story is remote from his immediate interest.

For a wrap-up on preparing the lead, you should keep the following four objectives in mind:

- Present a summary of the story
- Identify persons and places involved
- Stress the news peg
- Stimulate the reader to continue reading the story

## THE BRIDGE

Assuming you have written the lead for a story, what do you do next? In some stories, you will find the transition from the lead to the body of the story is a bit awkward. To smooth this transition, you use a writing device known as a **bridge**.

A bridge is a connecting sentence or paragraph between the lead and the body of the story. Although it is not always required, it can serve several useful purposes. For instance, in the bridge, you can place facts that are too detailed for the lead and too important to be placed lower in the story. Note the following example:

Novelty Lead: For sale: One guided missile destroyer.

Bridge: The Navy is thinking about inserting this advertisement in the nation’s newspapers. The guided missile destroyer USS *Benjamin Stoddert*, which is no longer fit for active service, will be scrapped next month.

Note that the writer used a freak lead to introduce his story. The entire lead consists of only six words, and the effect is good. The lead obviously would not be as effective if all the facts were presented in the first paragraph.

A bridge also can bring the reader up to date on past and present events related to the story by the use of **tie-backs** and **tie-ins**.

## Tie-Back

A tie-back is a newswriting device that allows you to refresh the reader’s memory about past events related to the story being written. It frequently is used in follow-up stories (see Chapter 5). Consider the example that follows:

**Lead:** The U.S. Coast Guard icebreaker *Northwind*, with the help of U.S. icebreakers *Glacier*, *Staten Island* and the Canadian icebreaker



*MacDonald* is free from the arctic ice pack that threatened to maroon it until next summer.

**Bridge** (used as a tie-back): *Northwind* was making the trip back from an attempt to resupply the research station ice-island T-3 when it began experiencing difficulties in the polar ice. The ice was so severe the ship lost a blade on its starboard propeller and cracked its hull.

**Body:** The relief ships punched their way through. . . .

### Tie-In

A tie-in is similar to a tie-back, except it provides information concerning other events that are currently taking place and that supplement the story being written. While the tie-back deals with the past, the tie-in deals with present events. Consider the following example:

**Lead:** Navy doctors are investigating an outbreak of 17 cases of scarlet fever aboard the destroyer USS *Balast*, a Norfolk-based ship operating in the Mediterranean.

**Bridge** (used as a tie-in): Meanwhile, measures are being taken to prevent further outbreaks of the disease on other Navy ships. Navy personnel have been warned to report to shipboard sick bays immediately if they find themselves suffering from fever, sore throat or rashes on the neck and upper chest.

**Body:** The first case of scarlet fever was reported aboard the *Balast* April 27, about three weeks after the ship left Norfolk. Doctors said . . .

The tie-in can explain or elaborate on one or more of the summary facts, usually why or how. In writing a summary lead, you may find that it becomes long and unwieldy if you try to include a detailed explanation of why and how. But if the explanation is important enough, instead of withholding it until the body of the story, present it in the bridge as in the example that follows:

**Summary Lead:** The Navy will begin replacing its time-tested manila

lines July 1 with a synthetic product of modern progress — nylon rope.

**Bridge** (explaining “why”): After months of study and experimentation, the Ships Systems Command has found that nylon rope is superior to manila line in strength, durability and elasticity.

If you have to include the information from these two sentences in your lead, it would become unnecessarily long and cumbersome. By explaining the why in the bridge, you present the information more clearly and make the story more readable. It can provide continuity and a smooth transition from the lead to the body of the story by bringing in one or more secondary, but significant, facts. Note the following example:

**Lead:** From now on, all of the accounting for the Navy’s vast network of ship’s stores will go untouched by human hands.

**Bridge:** CompuNav, an electronic data processing system, will do the job — and do it cheaper too.

**Body:** The CompuNav file computer was unveiled today. . . .

The bridge in this story is strictly a transitional device that helps close the gap between the lead and the body of the story. Reread these sentences again. Note how awkward the story would be if the bridge were omitted.

### THE BODY

For you to produce a smooth, final story, the lead and body must coincide. The body is the detailed portion of a news story that develops and explains the facts outlined in the lead (and in the bridge, if there is a bridge). Here again, the importance of a neatly tailored lead cannot be overemphasized. A cumbersome lead is most often followed by a cumbersome body. But when a lead has done its job, it will usually provide an outline for the orderly organization of facts in the body of the story.

To some extent the organization of the body is dictated by the material itself —if it is a series of events, for instance. So the writer has to write an orderly, well-organized story and at the same time keep in mind the relative importance of various details.

Guided by the idea of news importance, the writer proceeds through the story by selecting the next most

SUMMARY LEAD	EGLIN AFB, FLA (NNS) — A Navy officer who had never before taken control of an aircraft brought an Air Force spotter plane in for a rough but successful landing recently.
FACT 1 (bridge)	The incident came about after the pilot died of a heart attack during a routine training mission over the Gulf of Mexico.
FACT 2	Lt. John G. Graf, USN, of Aurora, Ill., walked away from the emergency landing only “slightly shaken up.” The incident occurred in an area 60 miles southwest of Eglin Air Force Base.
FACT 3	Graf took control of the single-engine plane and returned the aircraft to Eglin.
FACT 4	Presently assigned to Eglin as a Navy liaison officer, Graf reported to his present duty station last July.
FACT 5	A former enlisted man, the 39-year-old officer served as an aerial photographer for several years and his general familiarity with aircraft is credited with helping him land the plane.

Figure 2-8.—Diagram of a straight news story.

important incident, fact or detail, then the next important, and soon, until reaching the least important of all. At this point, the writer has reached the apex of the inverted pyramid with material of least value. The writer now knows that the makeup editor can slice one, two or three paragraphs from the bottom of his story without depriving the reader of the story’s chief news elements. Figure 2-8 shows a diagram of a straight news story structure.

### A FINAL THOUGHT

For several years, there has been a trend among civilian newspapers toward greater informality in news presentation. This trend has become known as “talking a story onto paper.”

Several years ago, an observant editor noticed that a reporter would come to the city desk and describe a

story he has covered. The story would sound attractive as he talked. Then the same writer would go to his desk and write the piece, pouring facts into the established newswriting mold. What had been interesting when he related it verbally then sounded like every other story that had appeared before — only the names and places were changed.

Recognizing the value of the reporter’s -conversational report of the story, the editor thereafter encouraged his writers to use a more conversational tone, coupled with simple language, in all their copy.

The main purpose of any news story is to **communicate the facts**. To accomplish this communication, the story must be read. When an informal story presented in simple, everyday language can accomplish this purpose, use it without hesitation.

## CHAPTER 3

# WRITING THE FEATURE, SPEECH, SPORTS AND ACCIDENT STORIES

In Chapter 2, the fundamental aspects of newswriting were covered. Once you master the basics of newswriting, then, and only then, are you ready to wrestle with the more complex news stories. This chapter will help you develop the skills and learn the knowledge necessary to write effective feature, speech, sports and accident stories.

### THE FEATURE STORY

*LEARNING OBJECTIVE: Identify the characteristics and structure of a feature story and the techniques used in producing a personality feature.*

Writing straight news strengthens the writer's powers of observation and builds his skill in using the English language. It impresses on the writer the necessity for ruthless editing until the story is specific, clear and vital.

Conversely, feature writing is not an exact science. Much depends on the skill, imagination and creativeness of the writer.

What is a feature story? It has been called the story that "has to be told." It has also been called simply "human interest." Interest in human beings, and in events because they concern people in situations that might confront anyone else, is called human interest. When a shipboard explosion takes the lives of several crew members and prompts the gallant efforts of other crew members to prevent the loss of the entire crew, the human interest, or appeal, may be of a sympathetic nature. A man with a broken nose might also evoke a sympathetic response. However, if the injury occurred when he walked into a telephone pole while scrutinizing an attractive 1957 Chevrolet on the other side of the street, the appeal might be of a humorous nature.

Certain topics have human interest built in. And, although they may not possess any of the other elements of news value (timeliness, proximity, prominence or consequence), they still have personal appeal. Human interest may fall into many categories, including those in the following list:

- Current topics
- The unusual and the extraordinary
- Mysteries and catastrophes
- Romance and sex
- Adventure and exploits
- Competitive contests
- Child, teen-age and adult life
- Animal life
- Recreations and hobbies
- Business, professional and home activities
- Social welfare
- Success and happiness

In any case, a good human interest story is built around the premise that the reader can easily identify with the subject or event. It involves a fellow human being and a situation that could happen to, or involve, the reader.

Human interest stories not only entertain, but are often informative in that they contain all the elements of a news story. However, the human interest aspect of the story outweighs its value as a straight news story.

Major news events seem to tell themselves. The straight news writer can set down all the facts, arrange them together with appropriate words and have an adequate news story. The feature, however, must be brought to public attention by the creative writer. As a Navy JO, your job is to recognize the human interest possibilities of stories and turn a drab yarn into a bright one without exaggeration or distortion

### CONTENT

The feature story is similar to basic newswriting in that it has a news peg. What sets it far apart, however, is that it emphasizes something new, odd or unusual. Both of these attributes are covered in the following text.

## News Peg

The Cuban Missile Crisis of 1962 was an event with intense, hard news value. Confrontation between the two strongest world powers could have been the lead paragraph on the story of World War III. Events in this confrontation made the news wires sing for many weeks.

When the USS *Norfolk* intercepted a Russian ship removing missiles from Cuba, the New York Times News Service covered it in a lead that read as follows:

The captain of a Soviet freighter reluctantly stripped the tarpaulin covers from eight medium-range missiles on the deck of his freighter Friday for photographing by a United States destroyer.

Using this news event as a peg, and realizing that he could not compete with news-service speed in making releases, the PAO aboard *Norfolk* released a feature with a different slant:

Much of the old-style drama and military dash of the international crisis is a thing of the past. The thrill of “Victory at Sea” is no longer as graphic in its modern context as that famous World War II documentary movie.

Today’s coverage of events that shape the lives of nations comes, often as not, from the centers of government and military command posts. For the chess game of world events is no longer played in the smoke of battle, but in planning rooms where statesmen, military personnel and civilians in government call the plays thousands of miles from the scene of the move. ...

## New, Odd or Unusual

The event and object sources are rich in feature prospects. Here, the imagination and curiosity of the writer are put to the test. Most hobbies are quite commonplace, yet an ordinary hobby can provide good story material if there is an element of the **new**, the **odd** or the **unusual** connected with it.

In conjunction with hobbies and collections, museums supply fine material for stories. Here the ideas usually come from historical circumstances surrounding the objects of their development. Browse

through a museum and ask yourself these questions: Why is this object on display? What significance does it have? What historical event is connected with it?

Stories concerning historical events must be especially well-written and interesting because people do not like to read about events presented in textbook style. However, they are interested in what one person or group did in a particular historical event.

These are a few common areas that produce ideas for articles. There are many others. The point is, the ideas are there and you must open your eyes to them.

## REQUIRED FEATURE WRITING SKILLS

To become a successful feature story writer, you must be proficient in the following feature writing skills: grabbing the reader’s interest, being observant and writing about people. These areas are examined in the following text.

### Grabbing Reader Interest

To attain reader interest, features may depend on prominence such as that in an event like the Cuban Missile Crisis. The personality profile would also fit here. And, in this case, the relationship between the news elements of proximity and prominence should be considered. For example, a story about one of the space shuttle crew members would be of interest almost anywhere because of the prominence of the subject. How about the CO of Agana Naval Air Station? The proximity to NAS Agana and surrounding communities might make the CO prominent enough to merit a personality sketch in the local Guamanian newspaper, but nowhere else, except perhaps, his hometown.

Consideration for the target readership, then, is important for the writer of feature articles. It soon becomes obvious that attempts to define a feature story fall short, probably because the range of material is as broad as the full range of human experience. Anything people make, do, enjoy or respond to serves as a peg on which to hang the feature story.

Feature stories stir emotions, stimulate, divert and entertain. These objectives could serve as a goal for the feature writer, but they do not tell what feature stories are. Certainly, the account of one nation’s warship intercepting the missile-carrying freighter of another in international waters is capable of stirring emotions and stimulating readers of the world.

The story behind the story — the feature story — is the vehicle for unabashed revelation of the human

interest element in any hard news event. The PAO's Cuban missile feature does this as it continues:

The Cuban Quarantine centers the eye of the world on the Caribbean, while the real events are charted far away in Washington and Moscow. The drama of confrontation is still very much set in scenes of ships patrolling the seas around Cuba. The lines of battle are drawn by ships every bit as powerful, many times as sophisticated, and just as serious as the battleship behemoths of former wars.

When the forces meet, as when the destroyer leader USS *Norfolk* (DL 1) detected the Russian merchantman *Leninsky Kosomol* steaming out of the south Cuban port of Casilda through the receding clouds of a tropical rainstorm, the surface action begins with the flashing light of exchanging calls.

Events followed rapidly as the radio waves emanating from the two ships pulsed messages reporting contact and requesting instructions. Agreements between governments born at United Nations sessions began to be implemented on the high seas. . . .

### **Being Observant**

The successful and prolific feature writer develops a keen, inquisitive faculty for observation. A well-tended landscape is not just a pleasant view to the feature writer. The journalist wonders who keeps it trim and why, inquires into the benefits of conservation or erosion control and the alternatives — wildlife sanctuaries or outdoor living. And chances are, the writer can write the answers received into an interesting feature article.

The power of observation, the habit of accepting nothing at face value, of digging into unanswered questions below the surface of the event, are invaluable to the feature writer.

A prime source of ideas is the daily newspaper. News stories that appear in the newspapers record national, state and local events as they happen. They usually do not give background material or cover all

aspects of a story. Yet everyday, news stories appear that open the way for a flood of feature articles.

The ability to take a bare fact from the news page and give it meaning can produce a good article, but here, as in wire service copy, the feature must reflect local interest. For example, a news story mentions a change in income tax regulations; the feature writer shows how this change will affect the reader. Thus the writer localizes the news story and gives it expanded meaning.

Military news, such as changes in regulations, pay, mission or anything affecting military readers, could also interest general readers. The alert and skillful writer can turn these bare facts, and sometimes dull items, into meaningful articles.

### **Writing About People**

The typical military editor of a commercial daily often feels "handouts" (standard news releases) are hounding him to death. They choke his style. They keep him tied to a computer doing rewrites. He would rather be working on a feature angle or out working up an enterprising story. He greets the daily handout pile as the worst part of his job. Why? Not because handouts do not contain legitimate news. Most of them do — buried somewhere behind, in or among fancy, \$10 words and reams of promotions.

Reporters say the typical military handout fails most often by the absence of names and addresses of those persons around which the story, event or action is built. They say infractions of several other basic rules of journalism also frequently draw the handout to the wastepaper basket, rather than to the printed page.

However complex and amazing a ship may be, a story that is more iron rather than flesh-and-blood sailors often sails right into the wastebasket along with the larger part of the handouts of the day.

What most media want in the way of a Navy feature is a particular individual — Seaman John B. Boatwright, 20, of 2810 Prairie St., Landlock City — performing his duties to make the vessel an efficient ship. Names, properly spelled and accompanied by ages and addresses, keep wire services and newspapers in business. Details of ships or stations are interesting to people back home, especially if those facts relate to sons, daughters, husbands or hometown acquaintances. A sparkling story about a search and rescue, for example, is a natural, both from hard news and feature standpoints — if those indispensable names, ages and addresses are included.

## STRUCTURE

The basic structure of the feature story is divided into three parts: the lead, the body and the conclusion.

### Lead

Any standard news or magazine-style lead maybe used to begin a feature story. It should, however, always be written in a reamer appropriate to the subject. Alight, humorous lead, for example, has no place at the beginning of a serious article designed to provoke deep and serious thought in the reader. On the other hand, a ponderous lead is no way to begin alight or humorous piece.

A simple summary lead was used to begin the following story:

A six-month renovating job on a dilapidated 70-year-old house won praise from a local real estate board for a U.S. Navy captain stationed here.

The preceding lead is adequate as a starter, but another writer used a question lead. The question lead is often used to good effect in feature story writing. Leads like these, when well-phrased, send the reader along into the body in quest of an answer to such a “way-out” question:

Ever hear of a “hurevac”?

It is a hurricane hideout. The 8,000 acres that constitute the Naval Auxiliary Air Station Meridian, Miss., are a rolling woodland, and it would seem they would be unaffected by the hurricane season hundreds of miles away from Florida. Such, however, is not the case.

Note that in feature writing, the lead often consists of more than a single paragraph. Sometimes the lead runs for several paragraphs. Take the following feature lead for example:

Fifteen months ago, a young Greek Cypriot landed in New York and took a job in a Brooklyn factory devoted to the manufacture of electrical appliances.

When he landed, he could speak only a few words of English and that in a thick accent.

Today that young man is Fireman Andreas Kalivakis, serving as an electrician aboard a U.S. Navy warship. His accent is fast disappearing; his English vocabulary is excellent and he is the owner of a new certificate indicating he has passed all the tests required to prove he has the equivalent of a U.S. high school diploma.

That lead stands the test for feature story leads; it grasps the reader’s interest immediately and makes the reader want to read more. A Marine Corps release excited the curiosity of the casual reader with the following lead, then added a startling transition that prepared the reader to take pleasure in completing the story:

Okinawa is far from the green hills of the United States, but an old-fashioned American-style still is in daily operation there alongside the radio section of Headquarters Company, Ninth Marine Regiment, Third Marine Division.

The still, however, doesn’t produce alcoholic beverages — it produces pure, distilled water.

Often a lazy journalist — relying on the belief that sailors are naturally interested in articles concerning their food, pay and equipment — will hang a dull lead on stories about those subjects. However, professional writers will give their best to those stories, because they know these stories will be read by the greatest number of people and be of service to them.

A dramatic example of wide interest to food comes from the guided-missile destroyer USS *Semmes*. Annual competition for the Ney Award for the best mess afloat sparked an enterprising skipper to support wider dissemination of his ship’s cooking secrets. *Semmes* published a cookbook of Navy recipes, cut to manageable portions, and the whole country took note.

Food editors featured the story in papers in New York, Chicago, Philadelphia, Pittsburgh, Indianapolis, St. Louis and Boston, as well as Charleston, S.C., Dayton, Ohio, Evansville, Ind. and Norfolk and Portsmouth, Va. Also, numerous network and local radio/television stations made wide use of the feature material.

Veronica Volpe of the *Pittsburgh Press* wrote the following example:

For those unaware of the military usage of the word, the phrase ‘the best small mess in the Navy’ might have questionable connotation, least of all merit. Not so to the crew members of the USS *Semmes* just returned from a Mediterranean tour and now undergoing overhaul in Norfolk, Va.

The military usage of “mess” relates to its original meaning — that of a group of persons who eat their meals together, as do the men of a ship’s company or an Army group. . . .

An important fact to keep in mind when writing about Navy equipment and weapons is that the reader can soon lose interest in a dull story about a machine or weapon. The reader is interested in the men and women in uniform who will handle, install, maintain and operate those inanimate — and intrinsically dull — pieces of hardware.

The effect of the machine on the person, and the person on the machine, must be presented in a way that emphasizes people, and the writer must make those people into rounded characters who become real in the reader’s mind. In other words, the story must have human interest.

The writer of the following feature lead did just that by beginning a story in the following way:

The machine, a metal monstrosity, squatted in the center of the metal deck, circled by a knot of Navy men: a bemused young officer, three puzzled sailors and a knowing old chief.

“I know what it’s supposed to do,” the first sailor said, “and I know where we’re supposed to bolt it down, but who’s ever going to operate a Rube Goldberg puzzle like that?”

“You are, buster,” the old chief said, “and . . .

## Body

When you write the body of a feature story, it is important for you to avoid monotony. You do this by varying sentence length, however, long sentences must be clear and easy to understand.

Note the varied sentence length in the following feature from the *Indianapolis News*:

The first — and last — issues of eight newspapers were published at Ft. Benjamin Harrison the other day.

But their brief life span had little relationship to the energy and interest devoted to their publication. The papers were the last journalism exercises for 70 servicemen and women, graduating with a newspaper in one hand, and a diploma from the Defense Media Institute at Ft. Harrison in the other.

From all the armed forces, staffers in the “quill and scroll” exercise got a glimpse into their military future. These military journalists will go to assignments throughout the world. Many will find jobs on more permanent newspaper staffs, using what they learned at Ft. Harrison.

Nine weeks ago, this basic military journalist class began. Since then students have spent 209 classroom hours in the Basic Journalism Department. ...

Another point to note is the use of quoted material to carry the story along. Skillfully conducted interviews with articulate experts will provide the writer with quotations. Such quotations, interspersed with expository material, help move a story along and maintain a lively spark throughout. Explanations and readily comprehensible revelations from authorities in a given field impart an air of authenticity to writing, particularly in stories about technical subjects, such as rocketry, instruments, engine improvements, jet engine overhaul and nuclear propulsion.

However he or she chooses to explain technical subjects, the writer should always remember the need to translate technical terms into lay language for the sake of the general audience. When this is not possible, the writer must define the technical terms.

When you write a feature on a technical subject, use the following points to help you plan and organize the body of your material:

- Make paragraph beginnings forceful to impel the reader through the story.

- Use technical terms sparingly, and include informal definitions as you go along.
- Dress up difficult or dull passages with human interest items.
- Quote authorities as necessary to make the reader feel the facts are authentic.
- Simplify facts by the use of analogy.
- Break down statistical material into figures the reader can comprehend.
- Compare scientific concepts and technology to objects with which the reader is familiar.
- Weave the necessary background into the story for unity and coherence.

For example, assume you are describing some microtubing used in a new guided missile. If you tell the readers it is three one-thousandths of an inch in diameter, they will have trouble visualizing it. Tell them it compares in size to a human hair and they can visualize its size immediately.

In another story, you can point out that a new jet aircraft carries more than 17,000 gallons of fuel. This is an impressive figure, but it does not mean much to the average reader. It would be more meaningful for you to tell the reader that the same amount of gasoline could power his car for the next 20 years.

Whenever possible, avoid generalizations. Use figures to backup any broad claims you may make. Do not merely say that the average sailor uses too much water aboard ship. Add force and emphasis to the statement with understandable figures. Tell the reader the average sailor drinks from two to four quarts of water a day. He uses five gallons of water daily merely to shave, brush his teeth and wash his hands. Cleaning and food preparation in the galley takes an additional five to eight gallons per crew member. In addition, he uses up to 10 gallons of water when he takes a shower. Then tell the reader why this is important: because the Navy “makes” its own water, drop by drop, by distilling it from seawater.

If pictures are not available and you have to describe a mechanical device, describe it in terms with which the reader is familiar: “The Navy’s new supercavitating propeller looks like the screw part of an ordinary kitchen food grinder.”

In studying feature techniques, the writer should not overlook the finest training material of all — the published work of other feature writers. When you

discover a piece in a newspaper or magazine that particularly interests you, you should read it again and analyze the devices the author used to make the work interesting, informative, entertaining or gripping. With a little adaptation and practice you can make the same techniques your own.

One thing you will probably discover is that when a story leaves you with a satisfying aftertaste, it is often because it was good enough to hold your interest to the end — and because the ending was a piece of artistic writing in itself.

## Conclusion

The conclusion of all good feature stories terminates the article in a positive manner. As in the lead, the writer is limited only by the ability in composing a conclusion.

One device frequently used is to summarize the key points of the story. Another way to end a story is to present a new fact, generally a fact that highlights the importance of the subject of the article. No matter how you do it, though, the ending should leave the reader satisfied that the time spent reading the piece was time well-spent. If you provided a tantalizing lead and a well-constructed body that held the reader’s interest, you owe to the story and the reader an equally well-written conclusion.

As mentioned earlier in this chapter, the feature lead example about USS *Norfolk* intercepting the Russian missile-loaded freighter sums up the action and puts the story in a new light by using a different twist. Consider the following excerpt:

Eventually, on orders from Moscow, canvas was rolled back on all eight 70-foot missiles. In six hours, governments had been contacted, orders issued and received, proving photographs taken, and not a shot was fired.

Suddenly the meeting was news — as much so as if it had been a major naval engagement — but not a shot was fired. The dull patrol of USS *Norfolk* had been broken, and momentarily the endless watches became meaningful. Its mission had been accomplished.

The next day, *Norfolk* returned to its station on the now familiar patrol and observed a famous armistice on



Veterans Day, November 1962, itself the new veteran maintaining the armistice in a new kind of war.

Not a shot had been fired. The “war” in Cuba was still cold.

A choice quote from an interview often makes a good ending for a feature story. The following example is how a Navy journalist concluded a story about a group of circuit-riding Navy dentists and technicians conducting a people-to-people dental program in Africa:

“We’re glad to get out with the African people,” said Nicholl (a chief dental technician). “The fact that there’s an element of danger in it is overshadowed by the thanks of the people we’re helping. We’ve never left a village or hamlet without a barrage of cheering and clapping from our patients.”

The story on the new piece of machinery ended with the following paragraphs:

Sure, they had hated it to begin with, that monstrous machine, but now it was their monstrous machine. Constant association and the care they had lavished on it had made it their baby. The ugly monster had become an object of beauty to them, a delicate thing to be protected.

A passing journalist, new on board, stopped to drink in its loveliness. He looked as though he might be going to touch her. “Keep your cotton-pickin’ hands off the baby,” Quinlon snarled, and the other two baby-tenders curled their lips at the JO until he scuttled away.

## PERSONALITY FEATURE

The personality feature is similar to other features in that it appeals to people’s interest in other people. It normally points out special achievement, success or obstacles surmounted in life and centers on a particular event or achievement.

Personality features differ from other features in that they are almost always about a single individual. This type of feature gives interesting information about the person’s life, rather than just the person’s opinions. The properly written personality feature is a vivid word

picture of the subject’s personality traits and physical features as well as a description of the things that make the person unusual or interesting. The effective personality feature leaves readers feeling they have met the subject face to face and know that individual personally.

## Research

Since the personality feature story delves so deeply into the subject’s traits and physical features, considerable research is required. Most of the required information must be gathered through interviews. Conduct interviews with the subject and persons who intimately know the subject or have something to contribute. Some information can also be obtained from printed background material and from personal observations of friends and associates of the subject.

Personality features should contain the following information:

- **Biographical data.** Use only that biographical data you feel is necessary to your story (i.e., age, hometown, parents’ names, major duty assignments, time in service, marital status, etc.). Unimportant statistics and data tend to bog a story down and make for dry reading. The tone of a story usually dictates the amount of data required.
- **Description.** Describe the person, the details of the setting, surroundings and general atmosphere.
- **Quotes.** Use quotations from the interviewee in which that individual’s principles for attaining success, and so forth, are related.
- **General accounting.** Present a general sketch of personal achievement, success, and so forth, in the words of the interviewee or friends of that person.

## Presentation of Information

In addition to the feature writing methods mentioned earlier in this chapter, personality features require a few techniques all their own. There are methods that can be used to enable you, as the writer, to make your readers feel they have met your subject face to face, heard that person speak, seen the individual act and know the thoughts or opinions and past life of the person. These methods are discussed in the following text:



**JO1 Jim Bryant**

**Figure 3-1.—Subject of a personality feature in her environment.**

- Telling of characteristic mannerisms and actions
- Using direct quotations in a characteristic manner
- Actually describing the subject's personal appearance, demeanor, facial expressions and dress in his or her environment (fig. 3-1)
- Giving the opinions of others about the subject
- Showing how friends and associates react to the subject

The following personality feature excerpts should help you see how some of the techniques are used:

Bryan Tyler of the station's imaging facility approaches his art seriously — with strong conviction and knowledge developed by extensive formal training and much practice.

He does not like photo contests but has won many. He would rather focus on the effects of people than photograph

people themselves — but does both well. ...

Tyler is a sensitive artist who why he takes photographs. ...

“I like taking peopleless photographs that relate directly to man either by content or implication,” as Tyler puts it.

During a tour of duty in Washington, the lanky Virginian worked primarily with official portraits.

“It can be frustrating shooting portraits,” emphasizes Tyler as he strokes his bushy black hair. “Everyone dressed the same with his only identity worn on his sleeve and placed in the same sterile environment. The portraits I keep, and feel satisfied with, show people in their own environment, or in a meaningful situation, hopefully conveying some insight into the subject.”

“In Petty Officer Tyler, I think we have one of the Navy's finest,” said his commanding officer, Capt. Rose Grosbeak. “There's not one person here who doesn't feel that way about Bryan.”

Tyler finds stimulation and excitement in searching for and producing meaningful photographs, even in the most mundane jobs. ...

“Photography should never end,” Tyler reflects. “All you should do is change subjects and fulfill some meaningful purpose, either to me or to the person for whom I am shooting.”

The material presented here gives the beginning feature writer a start in the right direction. Writing courses, taken from time to time, can help. Criticism from experienced feature writers and editors is a great aid. Studying the work of other writers, as mentioned earlier, is a fine guide to improvement. Reading about writing alone, however, never taught anyone to write. Like the disciplines of newswriting, the art of feature writing is learned by doing — **by writing.**



Helene C. Stikkel

Figure 3-2.—A speech story features something not officially disclosed before.

## THE SPEECH STORY

**LEARNING OBJECTIVE:** *Recognize the fundamentals of writing a speech story.*

Often, Navy JOs become jittery when first assigned to cover a speech story because they do not think they can get the facts or put them into story form. Actually, any writer who knows the fundamentals of news reporting can write a speech story.

First, the writing of a speech story resembles any other news story in many aspects. The most important fact, the climax of the story, goes in the lead. This usually means that the most important thing the speaker said goes in the lead. Occasionally, the most important fact may be something unusual — audience reaction, for instance — but generally, what the speaker said, either in quote or summary, is the feature.

The Secretary of Defense (SECDEF) may cover four major topics during an address, but the main point may have been the disclosure of a pay increase for all

military personnel. This fact goes into the lead as depicted in the following text:

“All active-duty military personnel will get a four percent pay increase January 1,” said Defense Secretary Justin N. Case in a speech before the National Press Club last night.

Merely that a speaker appeared before an audience has very little story merit. The speaker must say something newsworthy — something that has not been officially disclosed before. This normally happens when a speaker appears before the media in a news conference (fig. 3-2).

The subject title of the speech is rarely important enough to become part of the lead. Speech titles are usually catch phrases that reveal very little about what is the most important part of the story. For example, when the President of the United States speaks, the lead features what he said in the following manner:

“The president, in a major speech tonight, called for another tax cut. ...”

If the writer started off with the information that the president spoke, no one would have much insight into the importance of the speech.

In structuring the speech story lead, include **what** was said and **who** said it. **When** and **where** it was said can usually be included within the lead, if the lead does not become too cumbersome. If it does, include them in the second paragraph.

Usually a direct quote lead will not do, for most speakers do not summarize their talk in one sentence. Thus the writer should paraphrase the lead, summarizing what the speaker said in one brief sentence.

## PARAPHRASING

When you paraphrase, you must be careful to keep the speaker’s meaning. Do not quote out of context; that is, do not quote a sentence that gives a wrong impression when used alone.

For example, a reporter hears the president say, “I haven’t decided to seek reelection. However, I have instructed my staff not to be too hasty in looking for new employment.” If the journalist had quoted that first sentence alone, he would have given the impression that the president was not planning to run for another term in office, when that obviously was not what the president meant.

## QUOTES

When quoting, wait for a striking phrase or summary of a key point. Use quotes in a speech story to give the flavor of the speaker's talk. With quotes you can convey to the reader what the talk was like. To do this, the writer need not quote whole paragraphs because they make the copy dull. A few good quotes scattered throughout the story are enough.

To use quotes, you must understand the basics of quoting. A quotation must consist of the speaker's exact words. The writer should not change one word. You must use quotation marks at the beginning and end of the quote as in the next example: "I think, therefore, I am." You must use a comma to set off the quoted part of the following sentence: He said, "That did it." To add the words "he said" at the end of the sentence, put the comma after the quoted matter and before the quote marks: "That did it," he said.

When quoted matter does not make a sentence, use no comma and no capital letter to introduce the quote as in the following example: He did not "purge them." Note the periods and commas are always inside the quotation marks. No comma is needed after a quote if it asks a question such as in the following: "Did you go?" he asked. Also, no comma is needed with a quoted exclamation point as in the next example: "What a view!" yelled the astronaut.

On occasion, a speaker may make an error he does not acknowledge during a speech or news conference. If you must use this particular quoted material, insert [sic] immediately after the error. This shows, for the record, that the speaker made the error and not the writer. Consider the following example:

"NASA has experienced a very good safety record since the Challenger disaster in early January [sic] 1986. During this time frame. ..."

### Handling Long Quotes

Consecutive paragraphs of quotations do not require quotation marks at the end of each paragraph. These are required only when the entire quote ends. You do, however, begin each new paragraph with quotes. Nevertheless, as stated earlier, you can write more effectively by not using long quotes.

The ellipsis is a device of punctuation used in quoting. It consists of three spaced periods ( . . . ) used to show omission of a word or words necessary to complete a statement or quotation. If a quote is long and a writer wants to use it, the writer can delete the

unnecessary words by using the ellipsis. However, too many beginners go wild with the ellipsis. They overuse it, sticking the three dots in every sentence. If you must use several ellipses to convey the message, it is better that you paraphrase the sentence.

If the writer starts a quote in the middle of a speaker's sentence, the ellipsis need not be used before the quoted words. For example, the speaker may have said the following: "Considering all factors, and my staff has done that for many months, I feel the trainee would be ready for duty in a combat zone after 20 weeks of basic training instead of the present eight." A JO's sentence may read like the following: General Needam said, "The trainee would be ready for duty in a combat zone after 20 weeks of basic training instead of the present eight."

Then, if you want to end a quote in the middle of the speaker's sentence, leave four dots — three for the ellipsis and one for the regular period as follows: "The trainee would be ready for duty in a combat zone after 20 weeks of basic training. ..."

Quoting is only a part of writing the speech story. The writer must still identify the speaker no later than the second paragraph. Many times the speaker will be identified in the lead.

Even when you think a person is well-known, you must still include a full name and full title in the story. That way the reader will know exactly who you are quoting and will not confuse that person with someone else with the same name or similar position.

If someone is relatively unknown, you may use a general job title for the first identification, such as a college president or a city administrator. Include the speaker's name in the second paragraph.

### Quote-Summary Method

Combining the guidelines concerning quotes and the material covered earlier about identification, a lead and the second paragraph for a typical speech story should read in the following way:

President Roland Coaster has asked the Defense Department to revise its training and education systems so every man and woman in service will come out with a skill marketable in the civilian economy.

In his annual manpower report to Congress, the president said, "There are some military specialists whose training does not lead directly to civilian employment. To help them, I

<b>Quote</b>	“Take care of your men and women. They are the Navy’s most precious resources.”
<b>Summary</b>	This was the keynote of a speech delivered Friday by Rear Adm. Helen O. Troy, Assistant Chief of Naval Personnel for Education and Training. Speaking before the class of the Naval Officer Candidate School here, Adm. Troy emphasized the importance of maintaining good relations between officers and enlisted personnel.
<b>Quote</b>	“The Navy into which you are now going for your first assignment has a number of problems facing it,” Adm. Troy said. “One of the most serious is the failure of a high percentage of our first cruise Navy men and women to reenlist.”
<b>Summary</b>	Citing current facts and figures, the admiral pointed out that the reenlistment rate among first-termers was low. It would have to be doubled if the Navy hoped to meet its manning requirements 10 years from now.
<b>Quote</b>	“You must know your men and women and take care of them,” the admiral continued. “These are the cardinal rules. But I add two more: know what they are supposed to know, and help them learn it.”
<b>Summary</b>	Adm. Troy advised the graduating officers to study the same training manuals the enlisted community studies for advancement. She told them to use the same terms and the same approaches to their work that are taught to enlisteds in their schools and in their textbooks.
<b>Quote</b>	“There is no substitute for competence,” the admiral said. “When we are fat with peace and when our ships are cruising in quite waters, enlisteds may list fairness, kindness, and similar qualities as what they desire most in their officers. But come war and heavy winds,” she added, “they look for competence, ability, knowledge, and know-how.”
<b>Summary</b>	In closing, the admiral advised the graduates to guard the welfare of their sailors as they do their own, and there would be no first-term reenlistment problem.

Figure 3-3.—Speech story using the quote-summary method.

have asked the Secretary of Defense to make available, to the maximum extent possible, in-service training and educational opportunities that will increase their chances for employment in civilian life.”

An example of a lead with a lesser-known person may read as follows:

The Navy’s Chief of Information said in a speech last night that his office was requesting more than 100 additional public affairs duties and emphasized that a preplanned public affairs program was essential.

In the second paragraph the writer usually gives a fuller identification of the speaker, the occasion of the speech, where it was given, and, if there is room and it is noteworthy, the attendance. Next, the writer uses the quote-summary method of organization.

The quote-summary method uses one paragraph of quotes from the speaker, then one of the writer’s

paraphrase. It does not matter which comes first - quote or summary. This method allows the reader to get the flavor of the speech through the quotes but enables the writer to reduce the length of his story by summarizing large portions.

For example, the following is a quoted paragraph followed by a paraphrased paragraph:

“Our children can read, write, spell, do arithmetic and use grammar, which is more important than learning a lot of meaningless rules.”

In criticizing drill, or rote, teaching, the school superintendent argued that under former methods a child might win a medal in American history and still not understand the meaning of American democracy.

Notice that the paragraph of summary is related to the quoted one. The speech story, like any other, keeps related material together. Figure 3-3 illustrates a speech story using the quote-summary method.

## ATTRIBUTION

Besides the organization of the story, the JO must be aware of other problems in the speech story. **Attribution** — identifying the source of information or opinion — is needed in almost every paragraph. The writer must make it clear who is talking. Thus the writer should include attribution often. Beginners should attribute every sentence expressing opinion, for too often the reader forgets, and it seems the writer is making the statements in the story.

Attribution may consist merely of the phrase “he said.” However, to be sure the reader does not forget who the speaker is, the writer should occasionally insert the speaker’s name. The writer may put the attribution at the beginning, middle or end of the sentence, but the natural place for attribution is at the end of the sentence.

When writing a speech story, never use such words, unless quoted, as “I,” “our,” “us,” “we,” “me,” “you” or “your.” Standing alone, these words represent the writer’s viewpoint. So, if the speaker says our country needs more nuclear surface ships, the writer says: “The United States needs more nuclear surface ships.” If the speaker says “I,” it means just that and not the newswriter.

## “SAID” AND OTHER VERBS

Many reporters covering speeches are tempted to use vivid words to describe how the speaker talked. Unfortunately, the truth often conflicts with the vivid verbs. The best verb to use is “said.” Here is the natural and neutral link between the speaker and what he said. But many writers feel their creativity is stifled by using too many “saiDs.” There are, of course, synonyms like “cajoled,” “pleaded,” “beseeched,” “asked,” “murmured,” “digressed,” “asserted,” “told” “declared” and thousands of others that can often be used for variety.

When using these words to describe how the speaker expressed himself, be sure you describe the speaker’s emotions accurately. Always be alert to exact meaning and connotation.

## PAINTING A PICTURE

To add more color to the story, the writer may occasionally describe interesting hand movements or gestures the speaker made. An example appeared earlier in this chapter when Petty Officer Tyler emphasized a point as he stroked his “bushy black hair.”

When former Russian Premier Khrushchev removed his shoe and pounded it on a table at the United Nations, every story covering his speech included it high in the account. Most speakers will not be that flamboyant, but they may raise a hand toward the ceiling or pound on the lectern for emphasis. An occasional mention of this adds flavor to the story and points up what the speaker feels is important.

## GETTING THE FACTS

Before writing the speech story, you must get the facts. Most reporters depend on tape recordings or a copy of the speech. Frequently, a speaker may be approached — either directly or through his public affairs staff — for a copy of the speech if it is not supplied in advance.

Should you find yourself in a situation where you must rely on your own note-taking to gather facts, make sure you get the main points of the speech. A JO is not expected to be a stenographer, but you will still be held accountable for what you write. So listen carefully and write those quotes accurately.

Most professional reporters have their own system of note taking, which usually consists of shortcuts. For example, a writer may drop all vowels from words — sailor becomes “sir,” soldier becomes “sldr,” and so on. Similarly, the reporter may not dot the “i’s” and cross the “t’s” when writing rapidly. If you want to write down the word *responsibility*, you might dash off “*respons*” and later, when looking over the notes, the scribbling will be understood. Use your notes while they are fresh in your mind.

By using a homemade shorthand, you can listen to the meaning of the speech. You are waiting for the important points of the speech, not mechanically copying down every word as a stenographer does.

In summary, remember the following key ideas about speech stories:

- The most important fact goes in the lead (what and who said it).
- Use ellipses to handle long quotations.
- Use the quote-summary method to organize the story.
- Learn to attribute information or opinion in the story.
- Use vivid words carefully.



Tony Giberson

Figure 3-4.—Rugby is one of a wide array of Navy sports the Navy journalist will cover.

- Get the facts straight. (Use your notes, tape recorder and a copy of the speech when possible.)

## THE SPORTS STORY

*LEARNING OBJECTIVE: Recognize the principle of sports writing, the structure of a sports story, the use of quotes, the various sports writing rules and considerations and the sources of sports information.*

Sportswriting, whether it is for a great metropolitan daily or for a four-page internal Navy publication, can be the very lifeblood of a publication. No other editorial phase of a newspaper has quite so much to offer the imagination and creativity (fig. 3-4).writer — or so much to challenge the writer's

Sportswriting is a difficult side of journalism. It is tricky for the sportswriter who regularly covers a National Football League team. It is tricky for the JOSN

who wades through the task of writing an eight-inch story about a touch football game played on the base yesterday.

For some people, sportswriting is easier than for others, probably because they are athletes or because they are longtime fans. It is not true, however, that only ex-jocks and channel-hopping sports addicts can write sports. With a little training and practice, any writer can become, at least, an adequate sportswriter.

## SPORTS WRITING STRUCTURE

Writing about a game or a sporting event is essentially the same as writing a straight news story. Like straight news, sports stories are written in the inverted pyramid style (discussed in the previous chapter). The main difference between sports and news writing is in the lead. A sports lead usually emphasizes the **who** and **how** of an event, while a straight news lead usually emphasizes the **who** and **what**.

Like a news story, the lead is normally a one-sentence summary of the essential Ws and H, the bridge links the lead to the body, and the body is written to present facts in descending order of importance. We will now examine the lead, bridge and body of sports stories in more detail.

### Lead

Sports leads normally use the who and how as the lead emphasis. Leads should include the **who**, **what**, **when**, **where** and **how**. The **who** may be the teams involved or the names of key players. The **what** will normally be the name of the sport, league or tournament. The **when** should be the date or day of the event, and the **where** should be the location of the event. The **how** is usually a brief description of how the game or contest was won and the score.

**SUMMARY LEAD.** —In a summary lead, the **who** and **how** will be the lead emphasis. The final score should be in the lead and **not** repeated elsewhere in the story. Many beginning writers, in an attempt to summarize the game, repeat the score in the body. This is wrong. If the reader forgets the score, he can easily refer to the lead.

Consider the following example:

Alvin Gecko's second-half scoring binge led the Pensacola Goshawks to a come-from-behind 94-93 victory over the Saufley Mole Chickens in Wednesday night's basketball opener at Tallship Field House.

In this example, the lead emphasis is Alvin Gecko (who) and his scoring binge (how). This is a classic who and how summary lead, highlighting the key player and how the game was won. This is the tried-and-true sports lead, and the type all sportswriters should master.

#### **BACKGROUND INFORMATION LEAD.—**

The background information lead is another type of lead you should know about. It is a lead many sportswriters now use, especially when writing about games that have been broadcast over radio or television. Since readers are likely to know in advance the final score, who won and how the game was won, many sportswriters write leads that emphasize background information or locker room quotes to attract the reader.

The following is an example:

If Myra Naviete's sprained ankle slowed her down Saturday night, you couldn't prove it to the Naval Station Miami Pirates.

The speedy forward, who was sidelined three games because of an injury, scored 23 points to lead the Naval Security Group Hialeah Seminoles to a 56-37 victory over the Pirates in women's basketball action at Milander Gym.

Or:

Ugly.

That's the word coach Thomas Katt used to describe his Century Dolphins' 88-79 basketball victory over Rainbow Central here Friday night.

(Bridge) "We stunk up the gym," Katt said. "I hate to say it," he added, "but the better team lost tonight."

Note that these leads emphasize background information and are not one-sentence summary leads. They still include the essential Ws and H, however. Some newer journalism textbooks advise sportswriters to write this type of lead and to stay away from the simple summary lead. You may wish to follow this advice as you develop your sportswriting skills, but first you should master the bread-and-butter summary lead.

## **Bridge**

Bridges in sports stories serve the same purpose as news story bridges, primarily to link the lead to the body. Like news story bridges, they are often categorized by the purposes they serve, easily remembered with the acronym **WAITS**:

- **W**— Ws or H not answered in the lead are answered in the bridge.
- **A**— Attributes information found in the lead.
- **I**— Identifies persons or groups impersonally identified in the lead.
- **T**— Ties the story back to a previous story.
- **S**— Secondary facts are brought out in the bridge.

Very often, sports bridges are used to bring out secondary facts that explain the significance of the game. The bridge might, for example, explain that a loss drops the team into the losers' bracket in a tournament, that a victory ties the team for the league lead, that a loss marks the fourth in a row for the team, or any other important consequence.

Consider the example that follows:

The shutout is the first suffered by the Fightin' Giant Lampreys since losing 24-0 to the USS *Greystone* in the second game of the 1992 season — 39 games ago.

Or:

The victory extends USS Saufley's winning streak to eight and extends its lead to four games over the second-place Naval Hospital in the Blue and Gold Division.

## **Body**

Many beginning sportswriters incorrectly write the bodies of their sports stories chronologically. However, if the key play took place in the fifth inning or the third quarter, that is where the body should begin. Usually, the key play will be one that breaks a tie or gives the winning team the go-ahead margin. In baseball, it might be a four-run inning; in football, it might be a 60-yard touchdown pass; and, in basketball, it might be two clutch free throws in the final seconds.

Sometimes, the key will be a defensive play. It might be a blocked punt or a diving catch in the outfield



that prevents three runs from scoring. Sometimes, no single play will stand out. Then it is up to the writer to choose what to highlight. Analyzing statistics and interviewing coaches or players after the game can help you isolate turning points in the game.

If a key play happens to be an error, do not be afraid to write about it. Athletes put themselves in the public eye whenever they take the field, opening themselves to praise and criticism. If, however, you are writing about youth activities or Little League game, it is appropriate to avoid mentioning the name of the player who committed the error. In such cases, attribute the error to the team or position.

It is not necessary to write about every inning, period or quarter of a contest. If nothing of consequence happened during a period or over several innings, you do not have to explain that nothing happened. Rather, you may briefly explain with an introductory phrase like, "After two scoreless innings . . ." or "Neither team could move the ball until . . ." Do not bog your story down with detailed accounts of each batter or each ball possession; focus on the key plays.

### **USE OF SPORTS QUOTES**

Quotes are used in the same manner as in newswriting. If you have quotes from coaches or players, weave them into the story. Use them to introduce, support or explain your account.

For example:

'We knew that (Scott) Glengarry was going to beat the secondary sometime," said Blue Knights head coach Marc Antonius. "It was just a matter of time. With his speed, nobody is going to deny him for four quarters," he added.

Beat the secondary, he did. On a third-and-12, following a holding penalty, Glengarry raced down the right sideline, then slanted toward the middle. Quarterback Cocoa Butler hit him at the 20, and Price could have walked in from there.

Or:

The Battlin' Lemmings switched to a 2-1-2 zone early in the third period, and Stevens scored only two field goals the rest of the way.

"Gordian was killing us in the low post," explained Earwigs coach Kelly Pritchard. "When we went to the zone," he added, "we were able to double-team him and clog up the middle."

### **ATTRIBUTION**

Unlike newswriting, sportswriting requires little attribution. About the only attribution needed is for quotes or paraphrases. If the writer witnesses a game or event, he can write about the action without attribution. If he writes the story from scorebooks, he need not attribute the information because it is a matter of record.

### **SUPERLATIVES AND COLORFUL VERBS**

As an observer, the sportswriter may inject his opinions concerning the action he witnesses. He might describe a team's defense as "sloppy." He might describe a catch in the outfield as "miraculous" or a basketball player's leaping ability as "gravity-defying." In newswriting, this is considered editorializing; in sports, it is the observation of a qualified observer. Do not overdo it, however, and do not confuse this freedom with license to break the rules of newswriting. Save the superlatives for when they are warranted and for when you are confident you know what you are talking about. When in doubt, play it safe.

Similarly, the sportswriter is free to use colorful verbs or adjectives to describe how one team "smashed" or "clawed" its way to victory. People who read the sports pages or listen to sports broadcasts are accustomed to such language and expect it.

Do not, however, get colorful verbs confused with cliches. If you write "smacked the apple," you are resorting to a cliché. If you write, "smacked the ball," you are using a colorful verb.

It is all right to use sports jargon, such as "threw a bomb," "lobbed an alley-oop," "turned a 6-4-3 double play" or "busted a monster jam," when writing game accounts.

### **SPORTS TERMINOLOGY CONSIDERATIONS**

You must know the terminology and the rules of the sport you are writing about. If you are not familiar with the sport, it is wise for you to start reading the sports sections of as many newspapers as possible to see how experienced writers cover games.

Use the terminology for the sport you are writing about. If you are new to sportswriting and are not sure of the terminology, play it safe. It is better for you to say a batter “hit” the ball or a quarterback “threw” a pass than to wrongly use words like “slammed” or “launched.” You will lose your credibility fast if you write that a team “edged” another team, 104-57, or that a quarterback “fired a nine-yard bomb.”

Write in the active voice as much as possible. Do not write “was won,” “were victorious,” and so forth. Write, instead, “defeted,” “blanked,” “overwhelmed,” and so on.

## **TROUBLESOME WORDS**

A couple of words common in sportswriting trouble grammarians and some sports editors. The words are “win” and “host.”

Technically, “win” should not be used as a noun, and “host” should not be used as a verb, although many respected sportswriters and editors now accept such usage. Check with your editor before you write something like, “The victory marked the seventh straight win for the Eagles” or “The Eagles host the Naval Station Cervantes Cavaliers Friday.”

A similar usage problem arises with team names and pronouns. It is wrong for you to say, “NAS Pensacola began their drive on the 30-yardline.” “NAS Pensacola” is singular and “their” is plural. You should write, “NAS Pensacola began its drive. ...” You should use “their,” however, when you refer to a team by its plural nickname — Battlin’ Lemmings, Blue Knights, Fightin’ Giant Lampreys, Dolphins, and so forth:

## **RANKS, NAMES AND NICKNAMES**

In military sportswriting, it is common practice not to use ranks. However, your CO or office SOP may require their use.

Similarly, middle initials and such designations as “Jr.” or “III” are not used in sportswriting.

Nicknames, however, are common and should be used. The usual style for first reference is as follows: first name/nickname in quotation marks/last name. Note the following examples: Elvis ‘Toast’ Patterson or Evander “Real Deal” Holyfield. Sometimes the nickname comes before the first name, as in “Neon” Deion Sanders. On second reference, only the last name is used.

## **NAMES AND NUMBERS**

Just as in newswriting, names and numbers should stand out as red flags while copy editing; each must be double-checked. The difference in sports is that there are likely to be a lot more of both names and numbers.

Double-check name spellings and make sure numbers are correct. Also, make sure numbers add up, both in the story and in box or line scores.

## **SIDELIGHTS**

Do not confine your story to action that takes place on the field. Use sidelight information that may interest the reader: the size of the crowd, injuries that might have affected the outcome of the game, weather conditions, and so forth.

## **TYPES OF SPORTS TO COVER**

Sports encompasses more than just the big three (baseball/softball, football and basketball). On military installations, there are a number of other sports and recreational activities that warrant coverage, including bowling, tennis, racquetball, squash, golf, darts, boxing, wrestling, gymnastics, running, youth sports, and hunting and fishing.

## **STRINGERS**

For you to have a variety of sports coverage in your newspaper, you may have to develop a stringer system. It is important you remember that stringers are seldom trained journalists. Therefore, it is usually necessary for you to provide them with some training and brief them on your newspaper style and deadlines. More information on using stringers may be found in *Handbook for Stringers in the Armed Forces* (NAVMC 26-84) and in the *JO 1&C TRAMAN*, Chapter 7.

## **SOURCES OF SPORTS INFORMATION**

A problem for many beginning sportswriters is knowing where to gather the needed information. Consider the following sources and note that officials are omitted from the list because they are seldom, if ever, a source of information:

- **Morale, Welfare and Recreation (MWR)** for the ins and outs of recreation, intramural and youth programs, including rules, schedules and official scorebooks.



JO1 Jim Bryant

Figure 3-5.—The Navy Journalist will write about many types of accidents, such as this automobile vs. motorcycle mishap.

- **Coaches and managers** for details about team members, lineups and rosters, game plans, quotes and information about a contest, especially a contest you did not cover yourself.
- **Team members** for accounts of what happened in the game. Be cautious. Many losing teams tend to blame the loss on the officiating, whether they lost by one point or 30 points.
- **Official scorers** for game statistics and scorebooks. If you run a box score of the game, be sure your stats match those of the official scorer.
- **Fans** for color and sidelight information, where appropriate. Often used in sidebar stories, fan reactions can help tell the story of a team's success or misfortune.

Officials are impartial and usually refuse to comment. If an official's call is vital to the story, do not expect him to explain or justify it unless it is a matter of rule interpretation. **Never** ask an official about judgment calls (balls and strikes, close calls on the bases, whether a receiver was in or out of bounds when he caught a pass, whether a basketball player traveled, etc.). Officials are, however, legitimate subjects for personality and rules clinic features.

Additional sports coverage guidelines (including help on compiling statistics) maybe found in the latest edition of *The Associated Press Stylebook and Libel Manual*.

## THE ACCIDENT STORY

*LEARNING OBJECTIVE: Identify the structure of the accident story and the methods used to gather accident news.*

Five sailors are killed when one falls asleep at the wheel of his car after a weekend liberty.

A young Navy ensign dies in a flaming plane crash when something goes wrong with his jet during a routine training hop.

A Marine accidentally shoots a buddy with a gun he did not think was loaded.

An airman crosses an aircraft flight line and walks into the blades of a spinning propeller.

A civilian painter plunges to his death from a three-story Navy building when the lines in a scaffold break.

An explosion at a base facility kills 15 people and injures 35 others.

A Navy dependent child dies in an ambulance after drinking something from the family's medicine cabinet.

Accidents and disasters such as these take hundreds of lives each year. In addition to destroying life and property, they cause untold pain, misery and suffering to the victims' friends and relatives.

Yet, despite the undesirability of this type of news from the Navy's viewpoint, covering and writing accident stories is part of your job (fig. 3-5).

The following is an important tenet of Navy public affairs: **Accident news cannot be avoided or withheld, and it must be released.** The amount of information released varies with security and next of kin considerations.

Accidents can happen anytime and anywhere. Because they are unpredictable, unfortunate and undesirable as a source of news, the JO who covers and writes accident stories must be especially careful in handling them.

Accidents involve both life and death. They may cause human suffering, heartache and anxiety. Also, because accidents sometimes result from carelessness or negligence, they may injure reputations or lead to disciplinary action. A careless word or phrase in an accident story may cause great damage to the Navy, to individuals involved and to the careless writer. Therefore, **accuracy is of utmost importance** in the accident story.

In collecting information for a story, the journalist must be careful to avoid gossip and conjecture. You must be able to seek out proper authorities and get your information right the first time. You may not have the opportunity to verify it later.

You must stick to the concrete facts, resist any temptation to hide or cover up legitimate news, maintain high standards of good taste and, above all, be familiar with security restrictions and other limitations. You must know what to release and whatnot to release. Never will your abilities as a JO be put to a more exacting test.

## STRUCTURE

In any accident where a number of persons are killed or injured, the quickest and simplest way of writing the story is to use the accident/disaster story structure shown in figure 3-6. This structure is adaptable to all types of accidents and enables you to get the most important facts into the beginning of the story.

### Lead

The lead of an accident story introduces the reader to the basic facts in the situation by summarizing the five Ws and H (who, what, when, where, why and how). Consider this example: "Two San Diego sailors were killed and three others seriously injured today when their automobile blew a tire and smashed into a tree on Highway 80, five miles east of El Cajon."

Note that the lead answers all of the five Ws, but does not elaborate on any of them. The most important

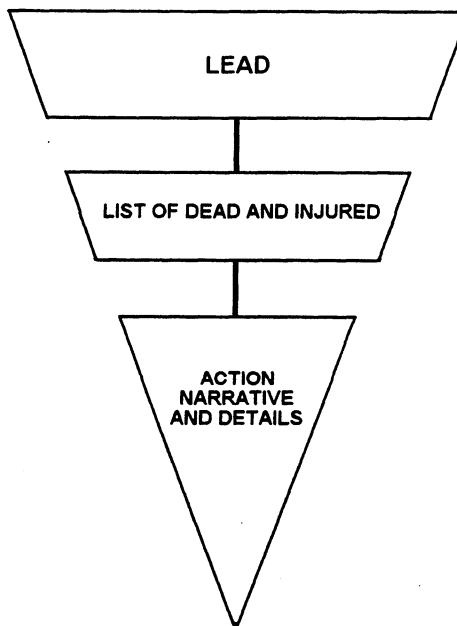

Figure 3-6.—Accident/disaster story structure.

facts in any accident story are the number and identities of the casualties and the cause of the accident. This lead immediately satisfies the reader's initial curiosity about these facts, but more detailed explanations are saved for the body of the story.

Since five people are involved in this accident, it would not be practical to list their names and complete identities in the lead. Therefore, they are included in the next segment of the story.

### Casualty List

The casualty list contains the names, ranks or ratings, ages, next of kin, hometown addresses and other pertinent information available on the dead and injured. A casualty list for the above lead might be presented in the proceeding manner (listing should be in alphabetical order to facilitate readers in scanning the list for known names):

Dead are:

Seaman Apprentice David K. Becker, 19, son of Mr. and Mrs. Daniel M. Becker of 821 Sherman Dr., St. Louis, Mo.

Seaman Jackson B. Painter, 22, son of Mr. and Mrs. Carl H. Painter of 680 Deamond St., Elmsdale, R. I., driver of the car.

Injured were:

Seaman Apprentice Bruce J. Burns, 22, son of Mr. and Mrs. Morgan J. Burns of Route 7, Nashville, Tenn., broken arms, shock.

Fireman Milton M. Jackson, 20, son of Mr. and Mrs. Ralph J. Jackson of 4210 Florida Ave., Lexington, Ky., skull fracture, internal injuries.

Engineman Third Class John C. Stole, 21, son of Mr. and Mrs. Alton H. Stole of 4109 American Ave., Long Beach, Calif., compound fractures, internal injuries.

The dead are always identified first in the casualty list, followed by the injured

In identifying the victims, it is again emphasized that all pertinent information related to them be included in the list. A newspaper near San Diego might use only the victims' names, ages and rates. The parents' names and hometown addresses might be cut because they have no local news value.

The wire services, however, would want all the information. A story like this would be picked up and served to newspapers in the victims' hometowns. Names of the parents and their addresses are important. By including all the information in your releases, you leave its use up to the discretion of the media. It may also save you the trouble of later answering queries for additional information. Also, note that the driver of the car has been identified among those killed and that specific injuries have been listed for those injured. Most newspapers follow this practice. This eliminates the need for cluttering up the body of the story with these details later.

If there are 10 or more casualties, the recommendation is that you place their names separately at the end of the story. The newspaper can treat the list as a sidebar or run the names in an adjoining box. Too many names in the casualty list cause a big break between the lead and the body, interfering with the story's progress.

The use of a casualty structure has two distinct advantages for the newspaper. First, this treatment gives each name more prominence in the story because of the typographical arrangement. Each victim is listed separately. The reader does not have to ferret out their names from one long paragraph. The reader merely runs down the list quickly to see if there is anybody the reader knows.

Second, the casualty list allows for easier handling in both the editorial department and the composing room.

Let us say the previous story appeared in the first edition of a newspaper. By the time the fourth edition of the paper is ready to go to press, one of the more seriously injured victims dies.

If the casualty structure is used, a complete revision of the story is not necessary. The editor makes a few minor changes in the lead and body of the story, then moves the name from the "injured" heading up to the "dead" heading in the casualty list.

### **Casualty Releasing Policy**

Under most circumstances, the names of casualties cannot be released until the next of kin have been notified. In this case, the story should be written and released in the customary manner. However, the space ordinarily reserved for the casualty list should include the following statement:

"Names of casualties are being withheld pending notification of next of kin."

Later, when the names are released, a newspaper may insert them in the proper place in the story. However, it is neither necessary nor desirable to withhold the other facts in the story until the names are available.

Current policy regarding the release of the names of the dead and injured, such as what can or cannot be released, is contained in *Department of the Navy Public Affairs Policy and Regulations*, SECNAVINST 5720.44A. (This publication will subsequently be referred to by its short title, *PA Regs.*)

If only two or three people are the victims of an accident, their names and identities should be incorporated into the paragraph structure of the story. Do not list them separately, name by name, as in the casualty list.

Let us assume that only one person was killed and another was injured in the previously described auto accident. The following is the way the names would be handled following the lead:

Seaman Jackson B. Painter, 22, the driver of the car, was killed instantly. He was the son of Mr. and Mrs. Carl H. Painter of 680 Deamond St., Elmsdale, R.I.

Engineman Third Class John C. Stole, 21, a passenger, suffered compound fractures and internal injuries. He is the son of Mr. and Mrs. Alton H. Stole of 4109 American Ave., Long Beach, Calif.

## BODY

The body of an accident story tells the complete story in detail. It may be developed in either logical or chronological order, but it should be written in a manner appropriate to the subject matter.

A straight fact story concerning a plane crash or an auto accident would ordinarily be developed in logical order after the casualties are listed. The most important facts would be presented first. An accident story, however, is most adaptable to chronological order development. In a heroic rescue, for example, where dramatic details play an important part, the story would be told in narrative form.

## STYLE

The style for an accident story is the same as for all newswriting. Simplicity, clarity and brevity are essential elements. More than ever, the writer should tell the story and stick to the facts.

Maudlin sentimentality or emotionalism — the old “hearts and flowers” routine — must be avoided. Phrases such as “tragic loss,” “grief-stricken family” and “went to his final reward” are the marks of an amateur. They are banned in most newsrooms.

There are also certain errors in syntax that are peculiar to accident stories. Note the examples that follow:

- Death may occur following an operation or during an operation, but not as a **result of an operation**. This implies negligence on the part of the persons performing it.
- Accidents **happen** and explosions **occur**, but neither takes place. That would imply they had been scheduled.
- Everybody dies ultimately of heart failure, not of a heart ailment.

- A fire is not a conflagration until it sweeps a wide area. Conflagrations are rare. A fire approaches conflagration proportions only when three or four city blocks are aflame.
- A fire may damage, destroy, gut or raze a house. It does not, however, partially destroy it or bum it to the ground.
- Although commonly used, planes do not collide in midair. They may collide on the ground or in the air. There is no way of determining midair.

Weather often causes accidents and disasters that make news. In addition, gale warnings, storms at sea and hurricane evacuations play major roles in Navy stories. Simple weather terminology, however, is frequently misused by the Navy journalist.

To avoid such misuse, some of the more common terms and their definitions with which you should become familiar are listed as follows:

- A **gale** is a strong wind with a velocity of 39 to 54 miles per hour.
- A **storm** manifests itself with winds of unusual force, ranging from 54 to 74 miles per hour. It is often accompanied by rain, snow, hail and violent outbursts of thunder and lightning.
- A **hurricane** or **typhoon** is a storm of intense severity and violence with winds exceeding 74 miles per hour. The difference between a hurricane and a typhoon is mostly a matter of geography. Storms west of the international date line are called typhoons; those east of the line are called hurricanes. Both are identified as cyclones in the Indian Ocean.

Certain medical terms crop up in accident stories from time to time. They should be simplified whenever possible as in the following examples:

- Abrasions — scratches
- Lacerations — cuts
- Contusions — bruises
- Trauma — shock

Damage figures are also frequently used. You should keep in mind that initial figures are usually estimates and should be stated as such. If the figures are unusual or high, they should be attributed to the authority who made them.

A person is widely known, not well-known. Nevertheless, even when widely known is used, it must be followed up with specific accomplishments.

Flowery euphemisms — once the rule in journalistic accounts of death — are no longer recommended in straight newswriting. They are less objective and are not more acceptable to the reader. Why say remains, when body is a more accurate description? The body is placed in a coffin, not a casket. It is usually taken home, not shipped. Funeral services, not obsequies, are held. The body is buried, not interned.

The descriptive terms “young,” “middle-aged” and “elderly” are often misused because they are relative. The criteria used by The Associate Press is as follows: “A person is young until he is 35, middle-aged from 35 to 65, and elderly after 65.” But if you think a person’s age is important, why use descriptive adjectives at all? Why not merely identify the person as being 35, 52, 68 or whatever the age maybe?

## GATHERING THE FACTS

Gathering the facts for a routine Navy accident story is simple. Often, the best source of information is the personnel office. The “casualty report” made by the personnel office and transmitted by priority message will provide you with most of the necessary information.

In gathering the facts for an accident story, make sure you get the following information:

- Casualty’s full name, including rank or rate, file or service number and branch of service.
- Status: Active duty or reserves.
- Type of death: Killed in action, died of wounds received inaction or death from whatever cause; the extent of injury: Injuries sustained and medical listing of patient, when available. Remember to attribute the stated cause of death to competent authority when the cause is not perfectly obvious.
- Date, hour, place, circumstances and cause, when determined.
- Location and disposition of body.
- Full name, addresses and relationship of next of kin.
- Information stating whether next of kin has been officially notified.

These facts usually provide enough information for a start. Note that the following report briefly answers all the questions necessary for an accident story. A few well-placed telephone calls will provide you with any other details you may need. The results may look something like those that follow:

A Little Creek sailor was killed today when his automobile went out of control, struck a railroad track and overturned on Sewell’s Point Road near Ward’s Corner.

The sailor was identified as Gunner’s Mate First Class John J. Doe, 37, husband of Mrs. Dolores E. Doe of 1717 Atlantic Ave., Atlantic City, N.J.

A veteran of 16 years’ naval service, Doe was attached to the Morale, Welfare and Recreation (MWR) Department, Little Creek Naval Amphibious Base. His death marks the first traffic fatality involving Little Creek naval personnel since February.

A routine accident story of this type usually runs about three or four paragraphs. It is brief and compact, yet contains enough information to satisfy the requirements of most newspapers.

All accident stories, however, are not this simple. When two or more casualties are involved, you will have to dig for more details and write a story with a casualty list. Listed next are some of the facts you should consider:

- **Accurate number and complete identities of the dead and injured.**
- **Cause of the accident.** Authoritative sources should be consulted and quoted whenever necessary. If the cause of the accident is not readily apparent, the story should state, “The cause of the accident is unknown and is under investigation.” Although the exact cause of an accident may be unknown, qualifiers sometimes may be used to present a probable cause in the story. For example, “An eyewitness to the crash said that the plane struck a treetop during takeoff.” The cause of an accident may be reported after a complete investigation has been made. Meanwhile, do not speculate in your release concerning its cause, especially when negligence or human error is suspected.

- **Date board of inquiry will be convened and its members** (if such a board is formed). Boards of inquiry usually are not formed unless the accident results in a major loss of Navy property, such as a shipboard fire. However, all aircraft accidents, even minor ones, are investigated thoroughly.
- **Lives still imperiled.** If people are still trapped, this rates coverage with the casualties and will require follow-up coverage as well.
- **Property loss or damage.** It is not necessary that you state the price of an airplane each time one crashes, but when a structure is damaged by the crash, media will want to know its value. You might want to keep a list on your desk of Navy aircraft and the approximate cost of each model.
- **Disposition of the dead.** State where the bodies have been taken.
- **Care of the injured.** Like the previous category, the care of the injured is especially applicable in off-station accidents. The story should state where the injured are being treated.
- **Statements from survivors, especially where heroic acts are involved.** Such statements are unnecessary in routine accidents. However, in a major catastrophe, they could be extremely valuable in piecing together a true picture of exactly what happened.
- **Rescue work still underway.** This is related to victims still imperiled.
- **Human interest items.** Noteworthy escapes, rescues or unusual circumstances involved should be acknowledged.

## OTHER FACTORS TO KEEP IN MIND

Accidents are caused by various circumstances. The major causes for most accidents are human error, mechanical failure, disturbances of nature and “acts of God.”

When a pilot misjudges the plane’s altitude, attitude or airspeed and crashes upon the deck of an aircraft carrier, the accident is due to human error.

If a hydraulic catapult aboard the same carrier explodes and kills several aviation boatswain’s mates, the cause of the accident might be mechanical failure.

If the same ship were battered about in a violent storm at sea, and several crew members were injured when they were thrown out of their bunks, the accident could be blamed on disturbances of nature.

Finally, there are accidents that cannot be attributed to any of the above causes, and therefore, are classified under “acts of God.” Note the following example: A bee stings the coxswain of a motor launch, causing him to lose his footing, fall overboard and drown.

When an accident occurs in the Navy and an account of it gets into the newspaper, the reader automatically looks for someone or something to blame. The reader often forgets that circumstances as well as persons and things cause accidents.

In writing an accident story, the Navy journalist should attempt to explain these circumstances. With proper handling, an accident story may result in better understanding and appreciation by the public of the everyday hazards Navy personnel face.

Take, for example, an aircraft accident in which the pilot manages to parachute to safety just moments before his plane crashes into an isolated field. Regardless of the fact nobody was hurt and there was no private property damage, many readers will approach the facts with a negative point of view. Unless told differently, they will think about the story in terms of carelessness” or “negligence.” Either the pilot did not know how to handle the plane, or the ground crew did not adequately prepare it for flight. These are typical reactions.

What the reader does not know, however, is that the plane might have suffered a flame-out over a heavily populated city. To protect the lives of people below, the pilot may have decided to stick with the disabled plane until it reached an unpopulated area. In doing this, the pilot jeopardized his own chances for survival.

The reader never learns these facts unless they are mentioned in the story. Decisions and actions such as these should not be included just in the story; they should be featured in the lead. It is your responsibility to have the common sense and ability to recognize these facts and play them up accordingly.

In another story, a sailor is killed in an auto accident. There is nothing unusual or spectacular about it. Nobody else is involved. The driver was killed when the car blew a tire on a sharp curve, veered out of control and smashed into a utility pole. Circumstances caused the accident.



Yet, when the story is published, a civilian reader may think — “Well, another one of those sailors from the base killed himself today. I wish something would be done about their reckless driving habits. It is not safe to drive the highways anymore.”

In a story of this type, the circumstances should be carefully explained. It might also be pointed out in the story that this was the first auto accident in which a sailor was involved in five or six months, if that is the case.

Try to wrap up your story with some positive information.

It must be emphasized, however, that under no circumstances should facts be distorted or sugar-coated to put an accident in a favorable light. If mitigating circumstances exist, they should be reported. If they do not exist, tell the story straight and stick to the facts. You should strive to treat all stories as impartially and as objectively as possible. Never give a newspaper, or any other medium for that matter, less than your best effort.



## CHAPTER 4

# WRITING FOR MAGAZINES

The “Navy story” can take many forms. All must be considered, and each, depending on the nature of the material to be presented, should be used.

One of these forms is the magazine. Too often overlooked by Navy journalists, this medium offers a ready market for virtually any subject one might consider. Since magazines cater to the tastes, temperaments and interests of specific groups, they offer an excellent medium for you to reach exactly the audiences you desire.

These groups, with their special identified interests, provide a possible readership for many stories that have little or no appeal to the general public. An editor for the *Washington Post* would have extreme difficulty finding any news value in a story about a San Diego-based sailor from Cleveland who collects coins. The editor of the *Numismatic News*, on the other hand, would welcome such an article and is even prepared to pay for it. The point is that the “Navy story” has many facets. Some are of interest to virtually everyone, some to relatively few. Whatever the case, all the stories should be told using the medium most appropriate for a particular story. Just remember — almost every story idea, even one conceived with another medium in mind, is also right for some magazine.

This chapter acquaints you with the various types of magazines and magazine articles. It also introduces you to the composition and styles of magazine articles. Finally, it offers you some tips on researching magazines, researching story ideas and getting your articles published.

### MAJOR CLASSES OF MAGAZINES

*LEARNING OBJECTIVE: Recognize the major classes of magazines.*

In general, the four major classes of magazines are as follows:

- Consumer
- Trade, technical, professional and business
- Company (house organs)

- Service-oriented

### CONSUMER MAGAZINES

Consumer magazines, the largest of the four classes, include all those publications found on the newsstand (fig. 4-1). Their contents attempt to appeal to the general public or to large groups in our society that share common interests. With few exceptions, consumer magazines carry advertising and are sold individually or by subscription. A few magazines that qualify as “consumers” are sold only by subscription.

Consumer magazines are made up of general interest publications and special interest publications. This distinction is made not so much for the readers as for the potential writers of magazine articles.

Magazines are purchased by people who expect certain things from a particular publication. For a magazine to be successful, those expectations must be met. Therefore, a writer must adapt to the style prescribed by a magazine’s editorial policy and submit only stories dealing with its expressed area of concern. Any disregard of this policy will result in a story’s automatic rejection, regardless of how interesting or well written it maybe.

### General Interest Publications

General interest publications, as the category implies, are intended for the general public. Their subject matter is broad, and their appeal usually transcends most of the boundaries of age, sex, race, education, occupation and geography. Magazines such as *Reader’s Digest*, *Life*, *Parade* and *The Saturday Evening Post*, fall neatly into this category. Each contains a variety of articles to interest a diverse audience. Others, such as *Time* and *Newsweek*, also qualify as general interest publications. Although they concentrate primarily on news and current events, they still cover a wide range of subjects, offering something for everyone. Also, their material is presented in an easily read style that explains a news story in a way any reader can understand.

Some magazines originally published for specific groups now attract a wider audience because of



**Figure 4-1.—Consumer magazines provide potential markets for magazine writers.**

alterations to their contents or the changing interests of the reading public. *Family Circle*, for example, is not read exclusively by women, and men are not the only readers of *Gentlemen's Quarterly*.

### Special Interest Publications

Special interest publications, as the term implies, are magazines directed at specific groups of readers with one or more common interests.

Some magazines attempt to cover all aspects of a broad subject, while others are concerned only with a particular element of the general subject. *Sports Illustrated*, for example, contains stories on practically any sport, but *Golf Digest* carries only stories related to golf.

Other special interest publications find their audiences through different demographic segmentations. There are magazines published primarily for men (*Field*

and *Stream*, *Playboy*, *Gentlemen's Quarterly*, etc.), women (*Cosmopolitan*, *Vogue*, *Woman's World*, etc.), boys (*Boys' Life*) or girls (*Teen*).

There are magazines for various age groups. For example, *Senior World* is published for senior citizens; *Modern Maturity* for men and women 54 or older; *Mademoiselle* for college women, ages 18-22; *Careers* for boys and girls, ages 15 to 18; *Children's Digest* for boys and girls, ages 8 to 10; *Jack and Jill* for children, ages 6 to 8; and *Highlights for Children*, ages 2 to 12.

There are also magazines aimed at blacks and other minorities. *Ebony*, for example, is intended for black men and women and could be considered a "general interest publication." *Essence* is one of a number of magazines published with black women in mind, and *Players* caters to black male readers.

Some magazines are published for residents of a specific location, such as *Phoenix* for citizens of

Phoenix, Arizona. Others, such as *Denver Living*, are for newcomers to an area. Still others, such as *Aloha*, *The Magazine of Hawaii*, are directed toward potential visitors to a particular city, state, or country.

There are magazines for the members of almost all religious sects (*Catholic Digest*, *Baptist Herald*, *Mennonite Brethren Herald*, *The National Jewish Monthly*, etc.) and most clubs, associations and fraternities.

In short, virtually every group has a corresponding consumer magazine published expressly for it.

## **TRADE, TECHNICAL, PROFESSIONAL AND BUSINESS**

Magazines in the trade, technical, professional and business class are published for active business people. The readers of these publications are looking for ways to improve their businesses and increase profits. While they might appreciate a little humor in the articles and want the material to be well-written, they are not reading them for pleasure.

These business journals are designed to appeal to one of the following three specific groups:

- Retailers
- Manufacturers
- Professionals and industry experts

Retailers, along with business people who perform various services, are interested in such subjects as successful sales campaigns and unique merchandise displays. Manufacturers expect articles dealing with ways to solve industry problems, such as personnel absenteeism and equipment failure. Professionals and industry experts want stories about new techniques and technical developments in their respective fields.

All of these business people are interested in making money and managing their businesses more efficiently. Therefore, the primary purpose of each of the business journals is the goal of helping its readers do their jobs better. Besides stories about business trends and solutions to problems, these publications often offer advice on ways a particular business can be operated more profitably.

### **Trade Journals**

While the term *trade journal* is often applied to all publications in the business journal class, there are subtle differences.

A trade refers to skilled work usually requiring extensive training, but not necessarily formal education, to master it. Carpentry is one example of a trade; printing is another. Therefore, a trade journal is a publication addressing the skilled laborers in a particular field, or the work they perform. *Motor Magazine* and *Ceramic Monthly* are examples of trade journals.

### **Technical Journals**

Technical journals usually discuss sophisticated material, equipment or instruments and their use. Examples of technical journals are *Datamation*, *Broadcasting* and *Photomethods*.

### **Professional Journals**

Professional journals are publications intended for professional people. This group primarily includes persons with a vocation or occupation requiring advanced education and training and involving intellectual skills. This group specifically comprises those working in such fields as law, medicine, theology, education, engineering, journalism, and so forth. However, the term *professional* has, in general use, been expanded. It now includes the executives, managers, department heads, some staff members and even the sales force of most business enterprises.

### **Business Journals**

There are business journals for those persons in, seemingly, every occupation imaginable. There is *Cashflow* for accountants, *Advertising Age* for ad agency personnel, *Chilton's Food Engineering* for those in the food and beverage processing industry and *American Psychologist* for psychologists.

There is *Scholastic Coach* for high school and college sports personnel, *Instructor Magazine* for elementary school teachers, *American Bee Journal* for amateur and professional beekeepers and *Grocery Distribution* for operators of food warehouses and distribution centers. *Police* is published for law enforcement personnel and *Editor and Publisher* for newspaper personnel. There is the *ABA Journal* for lawyers, *Private Practice* for medical doctors in private practice and C&S (*Casket and Sunnyside*) for funeral directors. *Across the Board* caters to business people.

## **COMPANY PUBLICATIONS (HOUSE ORGANS)**

Unlike business journals, company publications, or house organs, are produced by, or for, the businesses or organizations they serve. Their readers need or want certain information about the companies for which they work, and the companies try to provide it.

There are six basic kinds of house organs. Many of the larger companies publish them all. A number of companies consolidate their news into fewer publications. Some small companies produce only occasional newsletters for their employees. Whatever the case, all have a need to communicate to an internal or external audience. And all have a need for material that will interest their readers.

The six types of company publications are as follows:

- Employee
- Customer
- Stockholder or corporate
- Sales
- Dealer
- Technical service

### **Employee**

Employee magazines are designed to inspire and motivate employees. They keep workers up to date on company programs and policy and knowledgeable about employee benefits. They also provide recognition of the accomplishments of employees and inform co-workers of those achievements.

Published at regular intervals (weekly, monthly, etc.), employee magazines are much like ship and station newspapers.

### **Customer**

Customer magazines are produced to remind their readers of the desirability of using a company's product or service.

### **Stockholder or Corporate**

Stockholder or corporate magazines are published to inform a company's shareholders about policy and financial matters concerning that company.

## **Sales**

Sales magazines are publications designed to help a company's field representatives make more sales. These publications contain suggestions on generating customer interest in some product or service and tips on closing sales. They might carry an evaluation of a successful sales campaign and offer advice on ways for the sales force to use it in connection with their wares. Sales magazines also are useful in keeping a sales force abreast of changes and improvements in their products and for motivating personnel with articles on positive thinking.

## **Dealer**

Dealer magazines are publications produced to maintain an open channel of communication between a manufacturer and each independent dealer. They deal largely with facts about the manufacturer's product.

## **Technical Service**

Technical service magazines are publications that contain technical information necessary for using or repairing a manufacturer's product.

Many of the larger companies, and some of the smaller ones, have their own printing facilities and editorial personnel so they can produce their publications "in-house." Others employ only editorial personnel and "farm out" the printing requirements. Still other companies contract to have their magazines produced entirely by outside publishers. Regardless of the system used, the masthead of each magazine contains the name and address of the editor to contact about submitting material.

## **SERVICE-ORIENTED MAGAZINES**

Service-oriented magazines are those magazines produced primarily for military personnel (active duty, reserve and retired), military dependents and Department of Defense (DoD) civilian employees. That is not to say that these publications have no readers outside their targeted audience. Many of the service-oriented magazines are read with interest by such people as educators, contractors, former military personnel and "friends of the services," such as Navy League members.

However, Navy journalists writing for these magazines should remember to direct their articles to the primary audience. Service-oriented magazines may

be compared with the special interest publications in the consumer magazine class. They are directed at a specific group of readers with a common interest (concern about the military establishment). Some of these magazines are intended for readers in all the armed forces (*Defense News*), while others are directed at a single service (the Navy's *All Hands*). Still other service-oriented magazines are published for a select group within a broad specific group. Examples of this type of magazine include *The Navy Supply Corps Newsletter* and *Mech*. These publications could also be compared with trade journals in the company publications class.

Service-oriented magazines are generally divided into the following three categories:

- Internal
- Association-produced
- Commercial enterprise

While most government agencies and all of the military services produce publications for their people, here we are concerned only with those published for the Navy. Therefore, all references in this manual to internal magazines are only to those produced for an audience connected directly with the Navy. These internal magazines include publications produced by the DoD, Department of the Navy (DON) and individual naval commands. These publications can also include any magazine published by a command in another branch of service if at least one of the Navy's publics is apart of its targeted audience.

### **Internal**

Internal magazines are financed with appropriated, or in some cases, nonappropriated funds. They are issued periodically — most are monthly publications — and contain no advertising. They are distributed free to their intended readers throughout the fleet. However, these publications are available to anyone in or out of the service and may be obtained at prescribed subscription rates. Internal magazines are edited (except for articles submitted by outside sources) and written by military personnel and civilian employees of the federal government.

Examples of internal magazines are *All Hands* (mentioned earlier), *Link*, a quarterly magazine dealing with enlisted personnel information, and *Navy Family Lifeline*, a newsletter of educational and informational articles and feature stories of special interest to spouses and families.

### **Association-Produced**

Association-produced magazines are service-oriented periodicals sponsored primarily by associations interested in the military establishment and the individual services. In most instances, these publications are written and edited either by employees of the DoD or privately employed individuals. Most magazines in this category carry advertising to help with their financing.

Examples of association-produced magazines are *Proceedings*, sponsored by the U.S. Naval Institute, and *Sea Power*, sponsored by the Navy League of the United States.

### **Commercial Enterprise**

Commercial enterprise magazines are those published by private enterprises. They are financed by advertisers who want to reach a military audience.

Examples of commercial enterprise magazines are *National Defense*, *Military Living*, *Off-Duty*, and the *Times Magazine*. Magazines in this category are also listed with the special interest publications group in the consumer magazines class.

Commercial enterprise and internal magazines provide the most probable markets for most Navy stories. However, all possible markets should be considered when you are developing a story idea

## **MAGAZINE ARTICLES**

*LEARNING OBJECTIVE: Analyze the types of magazine articles and recognize the methods used in researching ideas for the various types.*

Magazine articles are the stories, news items and other copy, regardless of length, that appear in magazines. Before publication, any such material is called a **manuscript**.

Magazine articles may be either fictitious or true, and much of the information presented in this chapter can be applied to both types. However, since Navy journalists are expected to deal with facts, only nonfiction writing is specifically addressed here and throughout this TRAMAN.

The major difference between a magazine article and a newspaper story is the style in which each is written. Matthew Arnold, a famous nineteenth century

English poet and literary critic, once described journalism as “literature in a hurry.”

Arnold was not trying to belittle newspaper writers with that remark. He was merely noting that the obvious difference between news reporters and other writers is the breakneck pace at which newspaper journalists so often must operate. Newspaper reporters, by the very nature of their jobs, must carry the burden of unrelenting and monotonous regularity intensified by the pressure of deadlines. Working under those conditions could hardly be considered ideal for creative writing.

Now, however, even newspapers have discovered the magazine style, and many are even adopting its format!

Most newspapers report hard news in the traditional, inverted pyramid style but have had to use new tactics to compete with television coverage of timely news events. Their solution has been to provide in-depth coverage and a lengthy analysis of the news.

Many newspapers also have begun carrying any number of feature stories in their pages on a regular basis to boost circulation. Some newspapers now publish almost nothing but features, especially photo features. And almost all major dailies with large Sunday editions publish their own magazine inserts or carry a syndicated magazine insert, such as *Parade*.

Consequently, when you are searching for a market for your manuscripts, you may often need to look no further than your local newspaper. Remember, however, that newspapers are published more frequently than magazines, and therefore, they usually are governed by stringent deadlines.

“Traditional” magazines, on the other hand, impose no such deadlines. It is true that news magazines, financial publications and a few other periodicals have a need for timely material. However, those are not the magazines you are likely to approach about running your Navy stories.

While all magazines, of necessity, have deadlines to meet, they are only printers’ deadlines. Most magazines carry material compiled two to three months in advance of publication.

Sometimes a magazine staff member is given a deadline for writing an article for a particular edition, but usually outside writers are faced with no such constraints. Any idea you may have is yours to develop at whatever pace you choose. You can allow ample time for research, time for the actual writing and more time, as necessary, for rewriting. You can leave the project and

go on to other things, returning when you are ready. Then, when you are satisfied with your article, you are the one who decides it is completed. ‘Theoretically, all this is done before anyone else knows the article is in the offing. In effect, it does not exist until you are ready to submit it.

Realistically, you, working as a Navy journalist, are likely to be given an expected completion date for a magazine article assigned by your PAO. Also, after communicating with a magazine editor about a proposed article, you may be told that the article is needed before a particular date. Those instances could be thought of as deadlines, but not very rigid ones. They mean glancing at a calendar, not watching a clock. This more leisurely pace of writing allows the marked difference in style between standard newspaper stories and magazine articles. Basic news stories, you will recall from Chapter 2, are written in an inverted pyramid style. This form is preferred by newspapers and electronic media news departments because it presents all of the important facts at the beginning of a story. If there is not enough time to write or enough space or time to publish the complete story, a paragraph or two will usually suffice.

Since magazine articles are printed in their entirety, there are no requirements to put all of the important details “up front.” Therefore, magazine writers may use any format they believe best suits the material being presented. This allows the writers wider latitudes of expression and creativity.

The magazine form also provides writers with the opportunity to be more thorough in their storytelling. Both news stories and magazine articles deal with facts. However, while newspapers usually present the basic details without comment (except in editorials and columns), magazines amplify those facts in depth to show how they will affect the reader. When necessary, magazines also permit their writers to provide extensive background details to enable the reader to understand the subject more fully.

A newspaper’s news has a perishable quality; its value and interest diminish as the degree of immediacy wanes. The news in magazines, although less timely, is more enduring. Many magazine articles are as informative and interesting a year after publication as they were on the day they first appeared in print. Magazine articles also are remembered longer than newspaper stories because magazines are read more thoroughly, and at a more leisurely pace, than are newspapers.



## TYPES OF MAGAZINE ARTICLES

Any attempt to classify all of the forms of magazine articles would probably prove to be inadequate. However, certain characteristics do tend to identify seven general categories. These categories frequently overlap, and the dividing lines that separate them often become blurred. Even so, this classification serves as a starting point for learning to recognize the various types of magazine articles. This knowledge is necessary before you can even consider writing for the magazine industry. For our purposes, there are seven basic types of magazine articles. They are as follows:

- Personality sketch
- Personal experience
- Confession
- Narrative
- Utility
- Interview
- Featurette

### Personality Sketch

The personality sketch is a short biography that includes an individual's achievements. The "purpose of an article of this type, whether a success article or a profile, is to portray the intimate details of character and personality of someone. The person may be widely known, one who has achieved some form of greatness or someone whose life is in some way interesting or remarkable. The individual does not have to be a famous show business or political personality; this type of story could just as well be written about a Navy person.

A Navy jet pilot who adopted an entire orphanage of Japanese children was the subject of an article of this kind. Another dealt with a sailor aboard a destroyer who spent his reenlistment bonus on football equipment so his shipmates could compete against the crew members of larger Navy ships. Still other sketches have been written about Navy scientists, combat heroes, chaplains, test pilots and athletes.

### Personal Experience

Unusual adventures, unique accomplishments, rare travel experiences and countless other personal experiences lend themselves to treatment in this type of article.

"My 60 Days Under the Sea in an Atomic Submarine," "I Fly With the Blue Angels" and "I Walked on the Moon" are typical titles of personal experience articles.

Thousands of Navy men and women have had exciting personal experiences they might have developed into good magazine articles. Quite often, however, they do not have the ability, the time or the inclination to write these experiences on paper. Nevertheless, they usually will talk about their experiences which can provide a good story opportunity for a journalist in search of ideas.

When you write this type of article, use the "as told to..." byline. You should also use caution when writing in the first person. The frequent use of "I" can become, or appear, egotistical.

### Confession

The confession article is not necessarily a "shocker" or scandal story. Instead, it is an "inside story" of conditions or problems normally unfamiliar to the average reader. The confession article often involves handicaps or disadvantages that are overcome by determination and common sense.

Incidents related in confession articles are often typical of everyday life. A spoiled, rich kid learns discipline and responsibility aboard a Navy destroyer. A midshipman's determination to overcome a speech defect saves his Navy career. A young man cures a morbid fear of water by joining the Navy. Subjects like these have been used in confession articles. The most noticeable characteristic of the confession story is the intimate, confidential tone in which the writer seems to be personally revealing a secret to the reader. Although the subject matter is personal, it must evoke an emphatic response from the reader.

Humor should not be overlooked in this type of article. An individual's willingness to tell the story shows that he or she is not ashamed. If humor can be injected into the account, it indicates an objective approach.

Some subjects are best when given a humorous treatment. Many interesting articles about common phobias, such as a visit to the dentist, have been written that way. This approach often helps readers to see that most of the fear is unfounded. If the humor is skillfully handled, the readers will probably be amused.

Keep in mind, though, that humor must fit the situation. Flippant treatment of serious or distressful subjects will likely alienate your readers.

## **Narrative**

The narrative is especially suitable for writing about Navy subjects. Sharp characterization, vivid description, dialogue, action and suspense are skillfully woven into the framework of a narrative article to dramatize the facts. However, the facts must be adapted to this type of treatment. The writer does not invent them, exaggerate them or embellish them in any way. The story must be authentic even in the smallest detail.

The real life exploits and adventures of sailors the world over are told in magazine articles using the narrative approach. A heroic rescue, an epic battle, a dramatic struggle against the elements, a display of bravery and determination in the face of overwhelming difficulties are all subjects that maybe developed into narrative articles.

Careful research is important in writing the narrative article. This is especially true if it is about an event in which many of the magazine's readers may have participated. An important error or omission will immediately be noted by these people, and they will then be skeptical of the entire article. Also, the writing should be colorful and fast-paced. Otherwise it may sound like a chapter out of a history textbook.

## **Utility**

Any process, product, method or idea that will help the reader become wiser, healthier, wealthier or happier is a subject for the utility article. Also called the "how-to-do-it" article, the utility article is generally shorter than most other articles and the writing is usually expository or explanatory.

The Navy offers a wealth of ideas for the utility article. At one time or another, practically everyone has devised a scheme to improve a job, working conditions or equipment. These ideas are especially valuable if they can be tailored for a specific magazine. There are thousands of trade and employee magazines constantly looking for material of this type. Editors of *Popular Science* and *Popular Mechanics* build their entire magazines around this type of article.

The utility article can be compared to a set of instructions presented in an interesting and lively manner. Writers should ask themselves the questions they feel readers are most likely to ask, then answer

them clearly and simply. Even though some readers may be experts, writers must assume that every reader is unfamiliar with the information and provide complete details. A routine set of instructions for building a simple cabinet can be interesting if it is presented properly.

You can use the first, second or third person in writing this article. The personal experience approach can be very effective in the utility article. The third person style should be used only if the idea presented involves dramatic or entertaining situations. The most common approach is to use the second person, imperative voice (You fit the wrench ...).

## **Interview**

Interview articles present questions and answers that offer a subject's views on a given topic. Little background information is given in the article if the subject is widely known to the readers and the emphasis is on the topic of discussion. The interview requires much advance planning, however, and the writer should research the subject thoroughly before conducting the interview. Each edition of *Playboy* presents an excellent example of the interview article.

## **Featurette**

The featurette is probably the most popular and best-selling short article found in magazines today. It is short and simple, and it contains the element of oddity or humor, and sometimes both. The purpose of the featurette is to entertain.

"Humor in Uniform" and "Life in These United States," regular sections in *Reader's Digest*, are good examples of the featurette. Nearly every magazine carries at least one anecdote as filler material in each issue.

## **RESEARCHING AN IDEA FOR A MAGAZINE ARTICLE**

Every person, place, event or thing is a possible source for a magazine article. What one person sees daily and takes for granted, another person with a well-developed eye for the interesting and unusual often can turn it into a successful article. The idea sources and material concerning feature writing discussed in Chapter 3 also apply to magazine writing.

The Navy is a fertile source for subjects and ideas you can develop into good magazine articles. All you have to do is look around you. Better yet, thumb through

some of the current issues of the leading magazines. See what civilian professionals have written on the subject.

The sea, sailors and ships have fascinated readers for centuries. The modern saga of the sea and the men and women of the U.S. Navy is as thrilling as anything found in fiction. In many cases, the factual accounts of the modern Navy far surpass fiction material. Atomic-powered ships, supersonic aircraft, intercontinental ballistic missiles, earth satellites, probes into space and similar topics have stimulated the imagination of hundreds of writers. Yet, countless story ideas about those subjects are still available to you.

Opportunities in the magazine field for Navy journalists, or for that matter, any Navy man or woman with writing talent, are almost limitless. And to get started, one needs only to begin thinking.

Any magazine article, whether for a glamorous nationwide consumer magazine or for one of the Navy's internal publications, should begin with a good idea supported by a statement of purpose. An author without a purpose for an article easily loses sight of the intended goal. If an article would serve no purpose, the likely result would be wasted time and an unintelligible product.

Many beginning writers fail to narrow the subject to a workable idea. A sharp focus on a story idea is extremely important. The focus could be on an individual, an episode or theme, but it must be clearly defined.

The next step should take you, the writer, to the *Reader's Guide to Periodical Literature*. This guide is a cumulative index of published authors, subjects and titles that is current to within two weeks of its publication. When you use this reference, pay particular attention to the most recent coverage (by all publications) of your selected subject. This will help you determine if your idea is still fresh. Also, take notes to help you when you research information for the article.

You may also need to use some specific indexes for research. The *Air University Library Index to Military Periodicals*, for example, references all items that have appeared in service-oriented publications. Other special indexes, including the library card catalogue, the *Cumulative Book Index* and the *Book Review Index*, address subjects covered in a variety of other periodicals. You can also consult biographical dictionaries, encyclopedias, newspapers and pamphlets to learn about a particular subject. It is not uncommon for a writer to spend days, weeks or even months collecting information before an interview or visit.

One writer, preparing to write a personality sketch on a famous composer, spent six months doing research before he felt ready to interview his subject. During those six months, the writer spent three months reading about symphonies. He spent another two months studying that particular composer's works and a final month talking to people who knew the composer.

Obviously, you will not spend six months researching every magazine article you write. However, in most cases, you will need to do some extensive research. The in-depth nature of most magazine articles requires that the writer thoroughly understand the subject he or she is presenting. Unless you are writing from personal experience, you must be prepared to conduct whatever research is necessary to give your article the degree of authority it requires.

### Studying Magazine Styles

Knowing the markets for magazine articles is almost as important as knowing your subject. The best-written manuscript serves no purpose tucked away in a file cabinet or desk drawer. And the best-conceived idea for an article is of no value unless it is presented in an acceptable manuscript.

Studying magazines can solve both of these problems. Your research will tell you which magazine publishers are interested in your subject and the style in which they want articles to be written.

As you examine the magazines, you should be alert to the literary style or approach a magazine takes in presenting a subject. For instance, several magazines might handle a piece dealing with the DMI, but each would present it in an entirely different way. The *Educational Review* would probably want to know the concepts and techniques of instruction, the *RCA Electronic Age* might be interested in the use of radio and television equipment, *All Hands* would likely prefer a story about the faculty and students, and *Parade* might want emphasis on the educational angle and benefits to the individual.

Several publications dealing with the needs and requirements of magazines are available to assist you in your research. One such book is *Writer's Market*, published annually by Writer's Digest Books of Cincinnati, Ohio. *Writer's Market* contains a listing of nearly all consumer magazines and business journals published in the United States and Canada. Along with those listings is the following information:

- Mailing address of publication.

- Names(s) of editor(s).
- Frequency of publication.
- Circulation
- Demography of readers.
- Approximate number of manuscripts purchased per issue (if any).
- Method of payment (flat rate for manuscript, pays per line of copy, pays per word, pays percent of magazine royalties, pays in magazine copies, pays nothing).
- Rights purchased (all rights; first North American serial rights; simultaneous, second serial (reprint) rights; one-time rights; etc.).
- Whether by-line is given.
- Description of material desired.
- Description of material not desired.
- Whether photos are desired, and if so, payment rates.
- Minimum and maximum lengths of manuscripts.
- Lead time for submission of season and holiday material.
- Whether unsolicited manuscripts are accepted.
- Whether previously published submissions are accepted.
- Whether simultaneous submissions are accepted. (Some magazines, especially regional ones, will consider such submissions if the offered manuscripts are not being sent to other publications in their state or geographical area.)
- Additional tips considered appropriate by various magazine editors.

You should keep in mind that most magazine editors have very specific ideas about material for their product. Any deviation from their expressed standards is almost certain to result in a manuscript's rejection.

The editors, especially those of the major, nationwide publications, can also be very selective in accepting material. Some will reject, out of hand, any offer of material from unpublished writers. However, the editors of many other publications encourage submissions by "new" writers. This is particularly true

of newly created, special interest magazines and many of the literary publications, or "little magazines," as they are sometimes called.

For Navy journalists this preliminary research is made much easier by the valuable assistance of the six regional Navy Offices of Information (NAVINFOs). NAVINFOs are field activities of CHINFO.

**IMPORTANT NOTE:** Manuscripts written as part of your official duties for civilian magazines *must* be marketed by a NAVINFO. You may send your manuscripts to Navy-produced magazines (such as *All Hands*) without NAVINFO involvement, but the aforementioned research rules apply.

Before sending your manuscript to a NAVINFO, you should call or write that activity, explain your story idea, then follow the guidance you receive. The NAVINFO will contact those publications most likely to use a particular story and notify you when and if a market is found.

If the idea has been accepted, you will be notified by the NAVINFO. They will then provide you information similar to that contained in the *Writer's Market*, mentioned earlier. Your NAVINFO will provide tips on the writing style preferred, advise you on when to submit your material and make suggestions for the length of your manuscript. The NAVINFO will also tell you if a commitment has been made by a magazine's editor to publish your story or if it is to be submitted on speculation.

The NAVINFO deals with the various magazines through correspondence called queries. In this context, a query is a letter from the writer, or in this case, the NAVINFO, to a magazine's editor. The query briefly describes a proposed article, and if required, contains up to three clips of the writer's previously published articles.

A favorable response to the query most likely will contain specific style tips — a list of do's and don's — on writing for that magazine. A large number of publications have their own styleguide booklets that are sent to potential writers. Early in your research of magazines or from the information provided by your NAVINFO, you gained a general insight into the style and editorial content of the magazine ultimately selected. Now you need to begin studying that magazine in earnest. If possible, get three or four different issues and read them thoroughly. Also, study the tips or styleguide supplied by the magazine's editor through your NAVINFO. Observe the character of the language. Note whether it is scholarly or adventurous, technical or

general, personal or formal, humorous or serious. You must also look for taboos on subject matter and content. Some magazines will not print slang, for example, and some will not mention their competitors.

When your research is completed, your story idea firmly fixed in your mind and your market clearly identified, you are ready to begin writing.

After having a few articles published by the same magazine, you will have developed a feel, or sense, for what that publication wants. Then you will be in a position to work leisurely on manuscripts whenever story ideas occur and you will be able to contact your NAVINFO about ready-to-publish material.

You should also give internal magazines, such as *All Hands*, the same intense study you give commercial publications. Navy internal magazines, like their civilian counterparts, have their own styles. Therefore, contributors, especially Navy journalists, should be aware of them and prepare their manuscripts accordingly.

While the editors of internal publications are more inclined to edit weak or unstylized copy than their civilian counterparts, you should refrain from making it necessary. You are expected to be a professional, and anything other than your best effort reflects poorly on you and your command.

As mentioned earlier, you are authorized to submit articles directly to Navy internal publications in the same manner your command makes routine news releases. You may also deal directly with those publications while you are developing a story idea. Although a formal query is unnecessary before submitting your manuscript, it never hurts to let the editors know what you are planning.

### **Outlining Magazine Articles**

Whether you are a seasoned writer or a novice, all magazine articles should begin in the same way — with an outline. Experienced writers may use rough, written outlines or formulate them in their minds, but beginners are wise to continue using the formal, written method.

An outline is a valuable aid in magazine writing. It helps you organize and evaluate your information and it makes writing an article easier and faster. You should develop, thoroughly, the outline and include all the specific details, explanations and anecdotes that contribute directly to the article you are writing.

Once you prepare an outline, concentrate strictly on the actual writing of your article. You already will know

what facts to include and where and how to use them. The basic magazine article outline may be divided into the following five parts:

1. **Purpose.** State the reason or reasons for writing the article and what you intend to accomplish. This sets a course to follow once you begin writing.

2. **Market analysis.** Study surveys that show which magazines are read by the population segment you wish to reach with your article.

3. **Markets.** List the magazines identified in your market analysis that are most likely to publish the article you are planning to write. Follow this up with queries to those publications. (Note: Parts 2 and 3 are performed by a NAVINFO when dealing with civilian magazines.)

4. **Sources.** List the people, reference books, magazines, and so forth, from whom or from which you expect to get the information needed for your article.

5. **Plan of development.** List pertinent facts, major areas of coverage, subtitles, anecdotes, and so forth, in the order you want to present them.

## **WRITING A MAGAZINE ARTICLE**

*LEARNING OBJECTIVE: Recognize the fundamentals of writing a magazine article and evaluate its components.*

Except for style, most of the rules and information concerning the fundamentals of newswriting presented in Chapter 2 of this TRAMAN also apply to magazine writing. You must be able to recognize the 10 news element categories examined there. The presence and intensity of any of those elements, other than immediacy, determine the newsworthiness of magazine articles as well as news stories. Furthermore, you must apply the “ABCs of Journalism” discussed in Chapter 2 — accuracy, attribution, brevity (to some degree), clarity, inherence, emphasis, objectivity and unity. You should also understand and follow the guidelines provided under the heading “The Language of Newswriting.”

As the categories of magazine articles overlap, so do the methods of writing used in each. However, a common pattern can be found.

A major element of most articles, one that gives flesh and blood to the story, is the anecdote. An “anecdote” is defined as any specific, short, significant story or incident.

Generally, a magazine article can be divided into four basic components:

- The title
- The lead
- The body
- The conclusion

## **THE TITLE**

The title of a magazine article should tell the readers the nature of the article. It usually features a short, terse statement designed to attract their attention or to arouse their curiosity. The title should entice the audience to read the article immediately.

A title, like the article itself, should be slanted or directed toward a particular market. Each magazine has its own title requirements for style, length and typographical arrangement. Some magazines prefer titles that summarize the information in the article. Others want descriptive titles. Still others prefer titles that make striking statements. And some favor titles featuring questions, quotations, direct appeal or alliteration.

In developing titles for their articles, writers must be honest. They should not mislead the reader with facts not supported by the articles, and they should avoid exaggeration or sensationalism.

The title should convey the tone and spirit of the material featured in the article. Declarative sentences with concrete nouns and active verbs are best.

If you have not thought of a good title when you begin writing an article, do not worry about it. Few writers title their stories in advance. Usually, the facts will suggest something suitable as you write. Often a strong sentence in your copy will provide the exact title you need.

## **THE LEAD**

The lead of a magazine article is similar to the lead of a news story, except it is usually longer and nearly always more difficult to write. The lead may run only one paragraph in length, or it may run as much as 10 percent of the entire article.

Whatever space you allot to your lead, it must accomplish the following objectives:

- Indicate the central idea to be conveyed in the article.

- Contain a hint of the spirit and movement of the article.
- Locate the subject as to time and place.
- Show any relation that may exist between the facts and the reader.
- Generate enough interest to make the reader want to read the rest of the article.

Leads for magazine articles, like those for news stories, should be written in a manner suitable for the subject matter. The lead is the most important part of a magazine article. If it fails to sustain the readers' interest, they will not read the article. Therefore, many professional writers spend nearly as much time developing a good lead as in writing the remainder of an article. As trite as the expression may be, a good writer knows that "a story well begun is half done."

## **THE BODY**

The title of a magazine article attracts an audience's attention. The lead arouses curiosity, stimulates interest and whets the readers' appetite for more facts. The body of the article must keep the readers interested.

Keeping your audience interested for two or three thousand words is a tough job. To do this, you must weigh every word, every sentence and every paragraph carefully. The facts you use must not only be interesting in themselves, but they must be presented in an interesting manner.

The body of a narrative or personal experience story is probably the easiest to write. All you have to do is relate the details in the order in which they happened. With this approach, you can depend on the action to hold the readers' interest. However, an article that contains no action and only presents straight, factual information is harder to write. Because the facts themselves are constant restrictions, you must use skill and imagination in presenting them. The facts must flow from the article naturally, without awkward pauses or sudden changes in direction.

In all magazine articles, paragraphs should be written so they interlock. The end of one paragraph should lead naturally into the beginning of the next. Transitions should be used in such a manner that the readers are not even aware of them. The key for you to make the body of the article interesting is in appropriately inserting anecdotes, specific examples and hypothetical situations. These devices help illustrate points and emphasize important facts.

## THE CONCLUSION

A magazine article should end as dramatically as it began. When appropriate, use an anecdote that typifies the main points presented in the body. Surprise endings also work well. The conclusion should neatly and succinctly tie together all the threads of the article and bring it to a smooth finish. It should make the readers glad they read the article and leave them with the impression you wanted to make when you stated the article's purpose in your outline.

## TIPS ON MAGAZINE WRITING

Along with studying the information presented here, you should read as many magazine articles as possible. Carefully observe how the material in the various types of articles is organized. Be aware of the different styles used in different kinds of magazines when they print similar stories.

Note, especially, the leads written by successful writers. Examine their sentence construction — the manner in which they “turn a phrase.” Then try writing a few leads and short stories of your own. To see which feel most comfortable to you, emulate some of the techniques of those published writers you have been studying. Experiment! Even with the vast number of magazines available to writers, the market is still highly competitive. The same factors that allow magazine writers to be creative also demand it. Therefore, the ability to write skillfully is essential to your success in this field. And that skill can be developed, through your willingness to learn and your desire to write.

## MAGAZINE LAWS

*LEARNING OBJECTIVE: Determine the laws that apply to magazine writing.*

While Navy journalists are not expected to be legal experts, there are a number of laws that merit your attention.

All writers should be aware of laws concerning defamation, fair comment, the right of privacy, copyright, fair use of the writings of others and plagiarism. This is especially true for magazine writers. The nature of their work makes the possible violation of those laws ever present, and for some, very tempting. Special care must always be taken to avoid these violations.

One area in which you must be particularly cautious is in writing articles containing personal commentary, where a strong possibility of defamation often exists. Another area of concern is in writing articles about people who do not want the attention. In articles of this type, you run the risk of invading someone's privacy. And finally, make sure your research is for information, not for someone else's phraseology. Creative writing means being original. Do not be guilty of copyright infringement or plagiarism. Also, remember that under U.S. copyright laws, **anything you write on government time cannot be copyrighted.** See Chapter 10 for further information.

Chapter 10 of this TRAMAN addresses the subjects of libel, the right of privacy and copyright laws. An understanding of that material will provide you with sufficient knowledge of those laws and will allow you to write without worrying unnecessarily about them. However, if any doubts or questions arise about those laws, do not hesitate to contact a legal officer for advice.

If you want to write for commercial publications and receive payment for your efforts, you must observe certain rules.

Your writing and research must be done on your own time (after normal working hours or while on leave). It must not interfere or conflict in anyway with regularly assigned duties and may not be done in connection with official duties.

Access to information sources, such as public affairs offices, is available to off-duty Navy personnel just as it is to civilian writers. However, you should remember that any use of DON facilities, equipment or personnel is permitted only in connection with official Navy assignments. Additionally, restrictions on access to classified material that apply to non-Navy professional writers apply equally to you if you are writing for a commercial publication on your own time.

Your off-duty magazine writing must not conflict with the public's receipt of prompt and complete information on government activities through the usual public information media. Further, both the subject matter and the methods of obtaining it must be legal and consistent with accepted standards of conduct.

In certain cases, the restrictions on writing for commercial publications — in connection with official duties — are waived for key DON officials. The term *key officials*, in this context, refers to flag rank officers, Navy civilian officials GS-16 or higher, and civilian or military personnel whose official assignments are of unusual prominence or authority. Those individuals may

be authorized to produce byline writings dealing with national defense plans, policies, programs or operations for specific categories of exclusive publications. Their writings may be printed in official DoD publications or magazines of other government agencies, of course. However, they may also be published, exclusively, in company publications (house organs) or commercially produced service journals, bona fide scientific and professional journals or encyclopedias.

Few businesses are more competitive than the consumer magazine industry. Therefore, a publisher's desire for and insistence on exclusive material are very understandable. The Navy's policy, however, is to avoid favoring one publication over its competitors. It is also Navy policy to make sure all information for the general public is made available through the normally accepted public information media. This policy virtually rules out hard news or "big" stories being written as exclusives by Navy personnel and explains the restrictions on writing for commercial publication

Still, there are official stories you can write for consumer magazines. You just need to be a little selective.

A newspaper account of a rescue at sea operation, for example, could be turned into an exciting magazine article. Even though all the basic facts had been published at the time, a stylized retelling of the event could produce some worthwhile reading.

An approach of this kind would not conflict with the general public's free access to the information. It is also reasonable for you to assume that such a story, no longer an exclusive, would still be of interest to a number of magazine editors. Numerous story possibilities similar to that one are almost always available if you are willing to look for them.

## **MAGAZINE REVIEW AND CLEARANCE**

*LEARNING OBJECTIVE: Determine the methods of obtaining a review and clearance for magazine articles.*

While Navy journalists, as well as other naval personnel, are allowed and encouraged to write for magazines, certain restrictions exist that must be considered. Permission for Navy men and women to write magazine articles is contained in *PA Regs*. Also contained in *PA Regs* are the restrictions in magazine writing and the exceptions to those restrictions.

The restrictions apply to the subject matter of proposed articles and to dealings with commercial publications. Unless proper clearance is obtained, no commitment will be made to furnish any nonofficial publisher with an official or personal manuscript that deals with military matters or has national or foreign implications. Subject matter of that nature includes, but is not limited to, the following:

- Information of national interest
- Information originated at, or proposed for release at, the seat of government
- Information concerning foreign and military policy, atomic energy, guided missiles, new weapons or chemical, biological and radiological warfare
- Information concerning subjects of potential controversy between the military services
- Material concerning significant policy within the purview of other U.S. government agencies
- Information specially designated from time to time by the Chief of Naval Operations, or higher authority, as requiring clearance

Any material about which there is any doubt concerning its security value or propriety should also be submitted for review. Manuscripts requiring review and clearance must be forwarded to CHINFO. The material for review is to be typewritten, double-spaced on one side of each sheet of paper and submitted in quadruplicate. Manuscripts on subjects other than those just described may be offered to a publisher without prior clearance from higher authority. However, published copies of magazine articles should be sent to CHINFO for inclusion in DON files.



## CHAPTER 5

# ADVANCE STORIES, FOLLOW-UPS AND REWRITES

At one time or another in your career as a Navy journalist, you can expect to find yourself writing an advance story, writing a follow-up and rewriting a release received from an outside source.

Producing advance stories, follow-ups and rewrites first requires that you know how to write and, second, that you have a sharp eye for accuracy. You also must have a sound knowledge and background of the subject about which you are writing.

### ADVANCE STORY

*LEARNING OBJECTIVE: Interpret the rules and structure of the advance story.*

An advance story calls the public's attention to a coming news event which would possibly be missed if it were covered as a spot news story. It answers the following questions:

- **What** is going to happen?
- **When** is it going to happen?

Advance stories are used to promote practically every scheduled, major, special event. They provide the advance buildup and support required to attract attention, encourage participation and assure success. Few special events could succeed without the benefit of advance announcements by local media.

Suppose your command was open for public visitation. The event probably would be a complete failure if the public did not know in advance when and where it would occur, what activities were planned, who could attend and why the public visitation was being held.

### RULES

Three important rules for you to remember when writing and releasing advance stories are as follows:

- Do not shoot the whole works in the first story. In a publicity buildup, plan the release of major

facts so they may provide good news pegs for later advance stories.

- Do not ruin a good thing. Advance stories must contain legitimate news, not mere publicity puffs. Provide facts that readers will find worthwhile and interesting.
- Do not overexploit an event. Schedule your advance stories over a reasonable period of time, give enough new information in each release to keep your audience interested, but do not bore them with unnecessary repetition. The scope and importance of the event will help determine the time frame required to promote it adequately. Usually, three to four weeks will be more than sufficient.

### STRUCTURE

Figure 5-1 shows a typical example of an advance release that might be used to announce an Armed Forces Day public visitation. The first release should contain the bare information essentials. Subsequent releases should elaborate on the basic facts presented in the initial announcement. The actual number of advance stories is determined by what you have to tell. Each story should build up to the next one, with the most important news pegs timed for release during the week of the scheduled event.

Figure 5-2 shows examples of leads to advance stories following the initial announcement.

### FOLLOW-UP STORY

*LEARNING OBJECTIVE: Interpret the purpose, reader considerations and structure of the follow-up story.*

Like advance stories, follow-ups are part of an overall story. In many news situations, there will be important or significant developments in a story already released. These news developments must then be released to update the original story. This method of reporting is referred to as **follow-ups**, which, as the

**PUBLIC AFFAIRS OFFICE  
NAVAL AIR STATION CREVALLE  
PENSACOLA, FLORIDA 32509-4907**

**TELEPHONE: (904) 452-1736  
452-9999  
DSN: 922-1736  
FAX: 452-1799**

**FOR FURTHER INFORMATION, CONTACT:**

**LCDR MARTY MARTIN (PAO)  
JOC DONNA MELLOW (APAO)**

**OFFICIAL NEWS RELEASE**

**FOR IMMEDIATE RELEASE**

**RELEASE #59-93  
APRIL 23, 1993**

**NAVAL AIR STATION TO HOLD PUBLIC VISITATION**

Naval Air Station Crevalle will open its gates to the public on Saturday, May 15, in observance of Armed Forces Day.

The announcement was made today by Capt. Rosetta P. Stone, commanding officer of the station. Capt. Stone said the gates will be open to visitors from 10 a.m. to 5 p.m., and the general public is invited to attend. Parking facilities will be available on the station. Special buses are being scheduled for those who wish to use public transportation.

The theme for this year's Armed Forces Day is "The Modern Military Machine." Naval Air Station Crevalle will join with thousands of other military installations throughout the world in highlighting this theme.

The main attraction at the public visitation will be an hour-long performance by the Blue Angels, the Navy's famous flight demonstration team. Also planned are a number of displays and exhibits highlighting the great strides made in the development of naval aviation during the past 80 years.

Further details will be announced later.

- USN -

Figure 5-1.—Initial advance story containing the bare essentials.

The Blue Angels, the Navy's flight demonstration team, will provide an exciting hour-long program of thrills and precision flying at the Armed Forces Day public visitation at Naval Air Station Crevalle on Saturday, May 15.

Flying single-seat F/A-18 Hornets, the Blue Angels have been thrilling fans of Naval aviation...

A naval aviation "air museum," consisting of 20 aircraft that have played a major role in Navy history during the past 80 years, will be displayed at the Armed Forces Day public visitation at Naval Air Station Crevalle on Saturday, May 15.

Included in the air museum will be...

The former Secretary of the Navy, Jay A. Hawker, will be the guest of honor at the Armed Forces Day public visitation at Naval Air Station Crevalle on Saturday, May 15.

Now the president and CEO of the CompuTronics Computer Corporation of Tenafly, N.J., Mr. Hawker...

A display of naval aviation ordnance, including exhibits of the powerful Phoenix missile and other air-to-air and air-to-ground missiles, will be displayed Saturday, May 15, during the Armed Forces Day public visitation at Naval Air Station Crevalle.

Capt. Rosetta P. Stone, commanding officer of the air station, believes this Armed Forces Day celebration will be the best in the 55-year history of the air station. "I am very excited about..."

Figure 5-2.—Subsequent advance story leads.

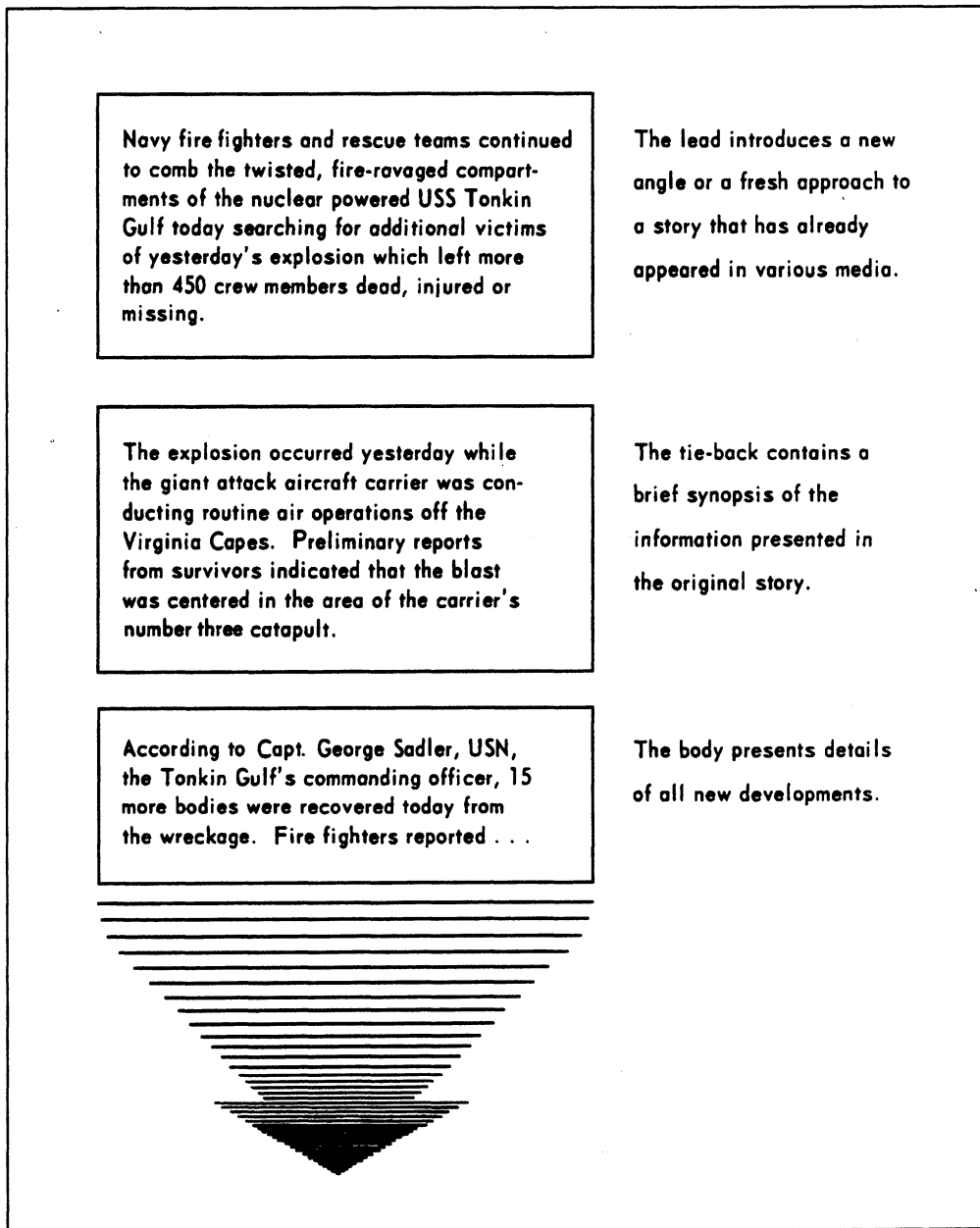

Figure 5-3.—Follow-up story structure.

name implies, follow up the facts presented in the initial spot news story.

### READER CONSIDERATIONS

In writing a follow-up story, you must consider the following two distinct groups: the reader who has read the original story and the reader who may not have read the original story. Using this consideration as a guide, your follow-up should be written so as not to bore the former or confuse the latter. You can satisfy the requirements of both readers by using the follow-up story structure explained and diagramed in figure 5-3.

### STRUCTURE

As you saw in figure 5-3, the follow-up story contains three distinct components — the lead, tie-back and body. These three components form the structure of the follow-up story which is covered in the following text.

#### Lead

The lead of a follow-up serves the same purpose as the lead in any other story. In a follow-up story, however, make sure your lead contains a fresh news peg, a new

angle or an entirely different approach from the one used in the original spot news story to which it is related.

### **Tie-Back**

The tie-back consists of one or two paragraphs located between the lead and the body of the story which contains a brief but clear synopsis of the information presented in the original spot news story. The tie-back is used to refresh the memories of those readers who saw the original story and to update those who did not see it.

### **Body**

The body of the story simply presents details of all new developments in the situation. It is usually written in the inverted pyramid style described in Chapter 2.

## **PRINCIPLES OF REWRITING**

*LEARNING OBJECTIVE: Recognize the basic principles of rewriting a story in terms of improving copy, updating the story, transforming informal reports, localizing, combining stories and shifting emphasis.*

The principles of rewriting are the same as those for good newswriting. If a story does not conform to acceptable newswriting standards, it should be rewritten and made to do so. In other words, you take what someone else has written poorly and convert it into usable news copy.

When you are assigned to a command publication, such as a ship or station newspaper, you will find that a certain amount of your material comes from contributors who do not write in journalistic style. Other material comes to you as handouts and from outside sources, such as clipsheets, naval messages, directives and official correspondence. If you want your publication to contain readable and consistently good material or if you have a local angle and want it to be accepted by commercial news media in your area, it is often necessary to rewrite it.

The following are six basic reasons for rewriting copy:

- To improve poor copy
- To update material

- To transform informal reports into properly written news stories
- To localize general information
- To combine two or more stories
- To change story emphasis

## **IMPROVING COPY**

Often, a person's first attempt at writing a story produces dismal results. Some members of a public affairs office staff may not be thoroughly skilled in the writing craft. Also, material for intended release is often received from other staff offices or departments. These articles frequently need the professional touch of a rewrite reporter. A rewrite reporter organizes a poorly written, improperly arranged item into a sequentially logical finished product.

A rewrite reporter may have to turn a straight news story into a feature. In this event, the rewriter often needs to acquire additional information and can expect to spend some time on the telephone — or in a face-to-face interview — before a finished product can be turned out.

There are times, too, when the rewrite reporter may have to convert a feature story — or a poor attempt at a feature — into a news story. Therefore, a reporter should be proficient in both types of writing before assuming a rewrite assignment.

One of the most frequent faults of badly written copy is the writer's failure to give ample play in the lead to the dominant news element of the story. The rewriter must dig through the story, find the proper lead, put it at the beginning where it belongs and, finally, organize the remainder of the story in coherent form.

## **UPDATING THE STORY**

Often, the rewriter must update a story that has already been printed. So naturally, this person needs a fresh angle to perform this feat. For example, assume that a military aircraft crashes with three people aboard. Two crewmen are killed and the third is missing. A story based on these facts would be released as soon as possible. Then suppose the third man is still alive, that he had managed to parachute from the falling airplane, had made his way back to a highway, caught a ride, telephoned the base and reported his experience. The news of a survivor is the fresh angle needed by the rewriter to update the story of the crash.

## TRANSFORMING INFORMAL REPORTS

Another reason for rewrite is to turn an informal report, such as telephoned information, into a properly written news story.

Cooperation between the JO in the office and the JO on the scene is important to the Navy, especially during times of fast-breaking news events, such as those experienced during a major accident or a natural disaster.

The initial release in these cases is generally compiled by one person who receives reports telephoned by reporters in the field. To make a single, comprehensive release, the office-bound JO adds background material available in office files and sometimes works with material brought back from interviews by other public affairs personnel.

Other routine news stories are handled in much the same fashion, without the hectic atmosphere and pressure of disaster stories. For example, the command's MWR petty officer maybe the public affairs office correspondent for athletic events. That does not necessarily mean the correspondent brings a finished story to the public affairs office, but rather, the correspondent telephones a contact there and reports the details of some sports event, and the JO turns that report into a professional release for local media and the command newspaper.

## LOCALIZING

Public affairs offices receive news from a variety of people and places. News releases from the DoD, DON, weapons manufacturers, shipyards, aircraft manufacturers and other outlets provide good sources for outside news. However, this news is usually broad in scope and slanted toward a general market. Therefore, it will require a certain degree of refinement and localization to meet the needs of your local readership.

When these releases are rewritten, the local angle should be introduced in the lead and the more general aspects minimized. For example, suppose you are attached to a naval air station and receive a handout from an aircraft manufacturer stating that a new type of aircraft is in production and will soon be made available to the Navy. The release contains a wealth of unclassified information about the plane and its potentialities.

A little research on your part uncovers the fact that an aircraft squadron at your command will be one of the first squadrons in the Navy to receive and operate the new planes. You can now combine your information with that in the general release — playing up the local aspect — and you will have a story of interest to local readers.

## COMBINING STORIES

In the case of combining stories, the rewriter often puts two or more stories together to make one. The combination generally results in a roundup story with the first paragraph carrying a combination lead to emphasize various news developments.

An example might be a combination of the following stories:

- A story is carried in the local paper about a hurricane that struck the area.
- A news release is issued by a nearby naval command citing several men assigned to that activity who aided victims of the disaster.

Both of these stories, wrapped up with a fresh release about awards for heroism presented to Navy personnel by the mayor of the nearby town, nets the rewriter a multi-interest, highly readable story.

## SHIFTING EMPHASIS

In Navy public affairs, it is standard policy to release the **same** story at the **same** time to **all** media. However, you will get better media mileage if you rewrite the same release several times to meet the needs of different media.

Suppose you wanted to get a certain story published in a variety of publications, such as the local papers, *Navy Times*, *Naval Aviation News*, one or more of the trade publications and several individuals' hometown newspapers. In addition, you think the story is worthy of airtime on radio and television.

Under normal circumstances, you cannot take the time to rewrite the same story several different ways and slant it to the particular needs of different media. Yet there are occasions when this is necessary, if you want to obtain maximum coverage for a special type of story. When this is the case, you will have to keep rewriting

## COMBINED SALVAGE OPERATIONS

### SAVE THE USS LST 291

A modern epic of the sea — unequalled in recent naval annals for sheer endurance and ingenuity — was written early this year near a tiny, coral-studded island in the Great Bahamas. It involved a grounded amphibious force vessel that was rescued from a treacherous coral reef after almost two weeks of relentless and frustrating efforts by ships and men of the Atlantic Fleet.

The salvage operations, which were carried out in the storm-ridden, shark-infested waters off Eleuthera Island, involved a dozen ships, the Navy's top salvage and underwater demolition teams and aircraft that were employed for everything from the evacuation of survivors to the transportation of explosives.

Practically every trick in the Navy's salvage repertoire was used, and many new ones were thought up to cope with the unusual and near-impossible situations that hindered the immediate rescue of the grounded ship.

The curtain went up on this modern epic of the sea about 0300 on 16 March with the Little Creek-based LST 291 churning its way through the dark and murky waters of the Great Bahamas. ...

Figure 5-4.— *Our Navy* excerpt.

## TUGS, FROGMEN, TNT

### FREE STRANDED LST

NORFOLK, Va. — Eleven days after running aground in the Bahamas, the shored-up LST 291 rode a two-line to Jacksonville, Fla., and the crews of at least eight vessels which helped it off the beach breathed weary sighs of relief.

In the early pre-dawn hours of March 16, the LST was homeward-bound with 118 Marine passengers and the amphibious gear they had used in the maneuvers at Vieques, P.R. Suddenly, it struck a submerged reef off James Pt., Eleuthera Is., Bahamas, and ripped a jagged hole in her hull.

Fifteen minutes after it hit, word was passed to abandon ship. Its passengers and all of its 96-man crew but a salvage detail scrambled ashore. ...

Figure 5-5.—*Navy Times* excerpt.

the story in the style preferred by each of the different media.

Figures 5-4 through 5-7 show introductions to four different accounts of the same story as published in *Our Navy*, *All Hands*, *Navy Times* and one of several hometown newspapers. Although all the stories concern the rescue of a grounded LST from a coral reef in the

Bahamas, note how the story is rewritten each time to present a new approach or to meet the style of the particular publication for which it was intended. Although a certain amount of additional work and effort was necessary, the rewrites resulted in 100-percent coverage.

## **BLASTING THEIR WAY TO SAFETY**

One of the more unusual salvage stories of the year is the tale of an LST grounded so fast on a coral reef that frogmen had to blast a 1,000-foot channel to free it.

USS LST 291 was churning its way through the waters of the Great Bahamas after completing two weeks of amphibious training exercises at Vieques, Puerto Rico.

About 1,800 yards off James Point, Eleuthera Island, the crunching of steel and stone shattered the silence of the night. The LST had hit a submerged coral reef. The grounding tore a two-foot hole in the evaporator room and twisted, warped and gashed the heavy steel skin in other parts of the ship's hull.

Water started pouring in through these openings and all of the lower compartments became flooded. Personnel were ordered over the side.

Although the nearest land was less than a mile away...

Figure 5-6. —*All Hands* excerpt.

## **DOING NEXT TO IMPOSSIBLE JUST ROUTINE TO NAVY CMDR.**

### **ROBERT K. THURMAN**

Cmdr. Robert K. Thurman, USN, the son of Mrs. R. L. Thurman of Cashmere, is earning high praise and recognition in Norfolk for his abilities as a Navy salvage officer.

His most recent accomplishment as a salvage officer was the rescue of the Landing Ship Tank 291 in the Great Bahamas after it had gone aground on a treacherous coral reef early this year.

With Thurman supervising the salvage efforts, the Navy LST was finally freed after almost two weeks of relentless and frustrating efforts by ships and men of the Atlantic Fleet.

Carried out in the storm-ridden waters off Eleuthera Island, the salvage operations involved a dozen ships, the Navy's top salvage and underwater demolition experts and aircraft that were employed for everything from the evacuation of survivors to the transportation of explosives.

But this was only one of many such operations in Thurman's long and eventful naval career. Other notable achievements for him involved the battleship USS *Missouri* and the military sea transport tanker *Wascissa*.

When USS *Missouri* went aground off Hampton Roads in 1950, Thurman was skipper of the salvage ship USS *Windlass*, which was instrumental in freeing...

Figure 5-7.—Hometown newspaper excerpt.





## CHAPTER 6

# COPY EDITING

One of the most important and exacting jobs on any publication is that of written copy being given the final professional touch of accuracy. This job of catching and correcting inaccuracies before they can be printed and distributed is called **copy editing**.

Readers may have a high regard for a newspaper that is carefully edited, but they quickly lose respect for one that is sloppy and full of errors.

The copy editor of both civilian and Navy publications represents the last line of defense against incorrect copy reaching the reader. It is the copy editor's job to make sure copy is not printed unless it meets certain standards. The copy editor is the guardian of both style and accuracy.

Always on the alert for questionable facts, ambiguous statements and violations of office policy, the copy editor must catch errors in grammar, spelling, syntax, punctuation, capitalization, and so forth; cut out words or sentences that are not needed; and add copy when necessary for clarity, emphasis or continuity.

Another responsibility of the copy editor is to restore objectivity to a story in places where a writer may have editorialized, quoted out of context or inserted an opinion without attribution to a source or pertinent authority. Also, the copy editor is constantly alert for statements of a libelous or slanderous nature. (Libel and slander are covered in Chapter 10.)

The copy editor of a civilian newspaper has an additional function of assigning headlines for the edited stories. Navy copy editors, unless they are editing stories for use in ship or station newspapers, have no responsibilities in this area. They could hardly be expected to know the styles, formats and individual editorial needs of all the newspapers that receive news releases from a public affairs office. It is, however, sometimes appropriate to put a brief heading on a story to identify its subject readily.

Like any typical, beginning newswriter, the neophyte JO is dismayed to see his "literary masterpiece" chopped up, pasted back together again and scored with the copy editor's pencil. Nevertheless, two minds are usually better than one. Most experienced

writers will admit that the final result, despite its mangled appearance, is a better piece of writing.

Security is of the utmost importance in the armed forces. The responsibility for security lies with every person who, in any way, handles a story, but the copy editor sometimes represents the last defense against a possible violation. If you have doubts about the security classification of any information you receive, check it with your security officer.

This chapter acquaints you with the standard symbols and style used by the copy editor and explains the procedures, rules and guidelines of copy editing. The basic pattern of news style in this chapter follows the style of The Associated Press and United Press International. Most newspapers in the United States now use this style. The recommended guide for preparing military news is the latest version of *The Associated Press Stylebook and Libel Manual*.

### COPY-EDITING PROCEDURES

*LEARNING OBJECTIVE: Identify the basic guidelines of copy editing.*

Copy editing follows a set system of procedures. To be absolutely accurate, you should read each story in the following manner:

- Read the story quickly to grasp its meaning and note its arrangement.
- Read the story more slowly and more thoroughly to correct every mistake and to add or delete material as necessary.
- Read the story again to check the copy editor's own corrections.

The final check is also intended to make sure that no new errors occurred in copy editing and that the story reads smoothly.

If the story contains too many mistakes and it appears obvious that copy editing will not improve it, the story goes back to the originating JO for rewriting, or in the case of copy received from outside sources, to a rewriter.

CONTOUR INTEGRAL 1-1-1-1

By JO3 Cedilla Circumflex

CONTOUR INTEGRAL, with ACUTE, Set for Commissioning

The ACUTE-equipped ~~guided-missile cruiser~~ CONTOUR INTEGRAL (CG 105) has successfully completed its initial group of sea trials and is scheduled for commissioning in July.

CONTOUR INTEGRAL is the lead ship in a class of 55 proposed guided missile cruisers which will carry the advanced ACUTE weapons system. The heart of the system is the "Mega-Match" AN/SPY-122-A Radar which is used to search for, detect, track and engage up to 500 targets simultaneously. Under development since 1994, the ACUTE system has undergone more than 200,000 hours of testing at sea in the USS CIRCUMFLEX (YTBF395) and at the land-based Combat Systems Engineering Development Site in Baylinguay, Florida.

CONTOUR INTEGRAL, designed as a "multi-mission" ship since planning for the class began in 1991, is fitted with standard and Redstone missiles, sixteen-inch guns, the SPITON close-in weapons system, chaff and numerous electronic decoys, spoofers and jammers. This will make the cruiser one of the most potent warships in the U.S. fleet and will enable it to provide effective anti-air, anti-surface and anti-submarine protection for naval battle groups in hostile environments, according to the Department of the Navy.

-more-

Figure 6-1.—Copy-edited story.

## PREPARING THE ROUGH

The original copy of a story is known as a **rough** (fig. 6-1). Normally, it is typed double-spaced on only one side of the paper. In general, a JO follows the same format in typing a rough as in preparing a finished Navy news release. It does not have to be as neat, however, and may include Penciled-in corrections, additions or deletions, as necessary. The rough obviously does not need the letterhead information usually carried on a release ready for dissemination. It is a recommended

practice in large offices for the author's last name to appear on the rough. This, of course, enables the copy editor (usually the PAO or the senior JO) to identify the writer.

## USING SYMBOLS

To prepare copy for reproduction in its final form, the copy editor uses a special set of shorthand symbols to indicate any required changes (fig. 6-2).

CONTOUR INTEGRAL 2-2-2-2-2

Recent reports on CONTOUR INTEGRAL in the media have described the ship as "unstable" and "overweight" and as being "unable to keep pace with a battle group." Rear Admiral Lucy Breve, CONTOUR INTEGRAL shipbuilding project manager, termed those reports "absolutely inaccurate." She said, "strength and stability limits are the very foundations of effective warship design." She dismissed the overweight charge, pointing out that ~~the~~ CONTOUR INTEGRAL can tolerate additional displacement in excess of 1,000 tons, <sup>said that it</sup> and will right itself in all sea states. CONTOUR INTEGRAL, "RADM Breve continued, "meets or exceeds all Naval Architectural and Operations requirements both for intact stability and (stability) under severe damage conditions."

Recent sea trials confirmed Contour Integral's ability to meet the "top level requirement" ~~at~~ <sup>of</sup> 50 knots ~~per hour speed~~. According to a summary of the tests, conducted in January and again in Mar, the ship exceeded 50 knots, handling high-speed, full-rudder maneuvers with ease. Another criticism called CONTOUR INTEGRAL's SFS-71 ~~air~~ <sup>there</sup> search radar "redundant," claiming, "It is not needed as a back-up, nor is ~~is~~ a technical reason to have it on the cruiser." Vice Adm. Roland Coaster, Deputy CNO for surface Warfare, responded by citing the system's "demonstrated value in air defense."

-more-

Figure 6-1.—Copy-edited story—Continued.

For example, if the writer forgets to capitalize a letter such as the "M" and "P" in mr. poindexter, the copy editor, using a soft lead pencil (the tool of the trade), would inscribe three horizontal lines under each letter that needs to be capitalized. The copy will then appear as follows:

mr. poindexter.

When the copy is corrected, the copy editor's shorthand indicates that the final work should read as follows:

Mr. Poindexter.

Most of the copy-editing symbols described in figure 6-2 are standard to both the Navy and commercial media. There will be only minor variations from one newspaper to another. You should learn these symbols and use them to make changes in your own copy and copy others submit to you.

## APPLYING BASIC RULES

What follows are the basic rules you should remember when copy-editing stories:

- Use a soft, black lead pencil.

CONTOUR INTEGRAL 3-3-3-3

In a report prepared earlier this year, the navy said, "The introduction of the ACUTE system represents a long-awaited and much-needed step in the development of ~~Naval~~ weapons systems. (CONTOUR INTEGRAL) will ~~bring~~<sup>f</sup> assets and capabilities to any ~~operational~~ environment from surface action groups to high-threat ~~carrier battle group~~ operations. ~~The~~<sup>z</sup>ship will do these things in a proven hull design and with a smaller crew than any ship of comparable size and abilities. It is a ship and a weapon system ~~for~~<sup>z</sup>the '90s and beyond."

-end-

Figure 6-1.—Copy-edited story—Continued.

- Make corrections above or within the lines where mistakes occur.
- Place the necessary copy-editing symbols at their correct points of insertion.
- Write legibly. Your longhand corrections will not do any good if they cannot be understood.
- Use scissors and either paste or a stapler to move a paragraph from one position to another in a story.
- If you want to add a new paragraph to the story, do not write it out in longhand in the margin or on the back of the original story. Type it out, then insert it where it belongs, using scissors and paste or transparent tape.
- After you copy edit a story, you should have a finished product. Any obvious mistakes that slip by will be attributed to the copy editor, not the writer.

SYMBOL MEANING	EDITED COPY	EFFECT
Capitalize	north island	North Island
Make lower case	the commander	the commander
Make caps and lower case	JOHN PAUL JONES	John Paul Jones
Insert letter	news stories	news stories
Change letter(s)	action photo	action photo
Delete letter, close up	typewriter	typewriter
Delete letter, leave space	petty officer	petty officer
Insert word	news photos	news and photos
Change word	record photos	record pictures
Delete word, close up	news worthy	newsworthy
Delete word, leave space	the men	the men
Insert space	news photos	news photos
Close up	news paper	newspaper
Insert period	the end The	the end. The
Insert comma, colon, semicolon	three, four and	three, four and
Insert hyphen	re- <del>enter</del>	re-enter
Insert dash	fact for example	fact--for example

SYMBOL MEANING	EDITED COPY	EFFECT
Insert quotes, apostrophe	We believe...	"We believe..."
Insert exclamation point, question mark	Wow!	Wow!
Delete punctuation	white) and blue	white and blue
Transpose letters	captain	captain
Transpose words	run fast	fast run
Transpose sentences, paragraphs	Apply same principle as above, or circle first item and draw arrow to desired position; note with $\lambda$	Apply same principle as above, or circle first item and draw arrow to desired position; note with $\lambda$
Abbreviate or spell out	Doctor Dr. 92 ninety-two	Dr. Doctor 92 ninety-two
More of story to come	more	
End of story	-30-, -end- or -usr-	
Not a new paragraph	battle. Sailors are	battle. Sailors are
New paragraph	battle. Sailors are	battle. Sailors are
Correct as written	Jane Austen	Jane Austen
Let it stand as before corrected	the F-14 Tomcat	the F-14 Tomcat
Center in column (heads and subheads)	Navy Day	Navy Day

Figure 6-2.—Copy-editing symbols.

## COPY-EDITING ELEMENTS AND USAGE

*LEARNING OBJECTIVE: List the elements applicable to copy editing and identify their usage.*

As a journalist assigned copy-editing duties, you should always strive for accuracy, rather than speed. You might adopt the slogan, “All I miss, they will print.”

Before you try filling the seat of copy editor, make sure you have a copy of the locally produced stylebook (see Chapter 7 of the *JO I & C TRAMAN*), as well as a copy of the latest version of *The Associated Press Stylebook and Libel Manual*. Both books are designed to standardize all newswriting and word usage for internal publications and for news releases to civilian media.

The copy-editing guidelines covered in this section are as follows:

- Style
- Editorializing
- Contradictions
- Incompleteness
- Names
- Numbers
- Spelling
- Punctuation
- Capitalization
- Abbreviations
- Military terms
- Religious terms

### STYLE

Everyone in your office should be acquainted with the locally accepted stylebook, but it is up to the copy editor to catch any violations of good style.

It is annoying for an editor to pick up a story and find, for example, the word “avenue” spelled out one time, abbreviated as “ave.” a second time and written as “av.” a third time. An office that is careless or inconsistent about little things may eventually become careless or inconsistent about big things. Once a news

medium loses respect for you, you might as well close shop. No newspaper will take the chance of publishing sloppy or carelessly prepared material.

Spelling, punctuation, capitalization, abbreviation and other mechanical aspects of grammar are details of writing that have a tremendously important impact on the clarity, readability and effectiveness of your copy. Once your office gets away from using a set stylebook, your news copy will slowly become a hodgepodge of inconsistencies.

### EDITORIALIZING

Editorializing happens when a writer consciously or unconsciously expresses doubt, censure or praise in a news story. The only persons permitted to express an opinion in a straight news story are the persons in the story itself. Even then, the opinion quoted must be attributed to the person who gave it.

News stories should be written in the third person. The writer’s personal opinions should **never** be injected into a news story. Facts should be reported as they are found, without personal pronouns referring to the writer.

Editorials are articles in newspapers or magazines in which the views of their editors or those in control of the periodicals are intentionally presented. However, such articles are clearly identified and purposely set apart from the publications’ news and features.

The electronic media also offer editorial opinions, but they, too, take care to keep them separate from their regular newscasts.

Editorials require a very specialized style of writing — the fundamentals of which will not be covered in this training manual. The focus of this section is the inclusion of personal opinions in your newswriting through carelessness or by design.

Consider the following examples of editorializing in straight news copy, then note the following suggestions offered to eliminate the implied opinions:

**Poor:** Lt. Post is exceptionally well qualified for the position.

**Improved:** Lt. Post, with a degree in law, has eight years of experience as a Navy legal officer.

**Poor:** An interesting program is planned for tonight at the Officers’ Club.

**Improved:** Here is tonight’s program at the Officers’ Club.

**Poor:** The punishment was unjust.

**Improved:** The U.S. Court of Military Appeals ruled that the punishment imposed by the court-martial was unjust.

## CONTRADICTIONS

Sometimes, a writer makes contradictory remarks in a story without realizing it. When contradictions occur, the copy editor should delete them or rearrange the facts more logically. Note the following four examples of typical contradictions:

### Example #1

Robinson's keen sense of responsibility, devotion to duty and hard work, according to his commanding officer, finally paid off May 16 when he was advanced to Illustrator-Draftsman Third Class.

The 16-year veteran is assigned to the aircraft carrier...

If Robinson is such a responsible and devoted worker, why did it take him 16 years to make DM3? The reader will assume that Robinson is not too bright or that the Navy does not reward good men and women.

### Example #2

A combat veteran of World War II, the Korean conflict and the Vietnam War, Capt. Garlin wears the American Defense Medal, the World War II Victory Medal, the Navy Occupation Service Medal, the National Defense Service Medal and the National Security Medal.

The captain may be a veteran of three wars, but his medals indicate he has seen no combat.

### Example #3

Chief Clayborne began striking for Personnelman aboard the destroyer USS *Mitchel* in 1945.

The Personnelman rating was established in 1948, so Chief Clayborne could not have been a PN striker in 1945. He must have started out in another rating.

### Example #4

Despite his 3-15 record and 7.89 earned run average, Bob Baker is considered to be a good pitcher.

Baker's pitching record and ERA speak for themselves. Classifying him as a "good pitcher" is both opinionated and contradictory. The writer would have to do a lot of explaining to justify this comment.

## INCOMPLETENESS

As a JO, you should have "news sense" —a quality that tells you which facts to collect and use and which facts to ignore. But if you do not have this ability or if you lose it momentarily, the copy editor must stop stories that are incomplete or inadequate and return them to you for amplification. This will save you the trouble of answering phone calls from news media representatives who want more detailed information.

Consider the following story, for example:

A Navy ground crewman was killed in an accident at U.S. Naval Air Station Bennington, the Navy announced today.

The man has been identified as George Pine of Chicago, Ill. He was directing a plane from the flight line onto a taxiway when the accident occurred. Bystanders reported that Pine walked into the blades of the spinning propeller. The pilot of the plane was attached to a squadron operating from the aircraft carrier USS *Loach*.

This story is compact and clearly written, but it will not satisfy the demands of the news media. Among other things, they will want to know the following:

- When did the accident occur? The Navy announced the story **today**, but nowhere does it say when the accident actually happened.
- Is there more detailed information on the victim? Readers will want to know his middle initial, age, rate, hometown address and data on his next of kin.
- How did the accident happen? The facts here are too generalized and vague.

- What was the plane doing at NAS Bennington when it was attached to the USS *Loach*?
- What is the name of the squadron, and where is the carrier operating?

A good copy editor should anticipate these questions. With a little copy editing, the story may look as follows:

A Navy ground crewman was killed by the spinning blades of an aircraft propeller last night at U.S. Naval Air Station Bennington.

The man was identified as Airman George A. Pine, 20, son of Mr. and Mrs. Andrew S. Pine of 8238 Earwig St., Chicago, Ill.

The accident occurred at 7:45 p.m., Japan time, while the crewman was directing an E-2 Hawkeye from the flight line onto a taxiway during a night exercise.

Pine noticed a flare pot near the plane's right landing gear and signaled the pilot to stop. As he attempted to move the object from the plane's path, he slipped in front of the aircraft and fell into its spinning propeller.

The plane and pilot are attached to Airborne Early Warning Squadron 779, normally based aboard the USS *Loach*. They were participating in night operations at NAS Bennington, while the carrier was docked at Yokosuka.

## NAMES

"Names make news," but they also make headaches for the copy editor. Is the man's name **Haufman**, **Hoffman** or **Haufmann**? Did the writer accidentally leave the "h" off the name **Smit**, or is that how the name is actually spelled? How about the name **Frances Jones** in a news story? The writer implies it is a he, but males usually do not spell their names that way.

The names **Pat**, **Carol**, **Marion**, **Jean**, **Gale**, **Merle** and **Terry** can be either male or female. Therefore, the use of such a name without the knowledge of the person's gender could lead to some embarrassing situations. And what do you do when you run across a name like Stanley Wozniawirsbinski? You may not be

able to pronounce it, but you had better make sure that it is spelled correctly.

To eliminate confusion for the typist or word processor when a name like Ppandrowske or Wozniawirsbinski is correct as written, simply draw a box around the odd but properly spelled name, as shown in Figure 6-2.

## NUMBERS

"Numbers do not lie," but a good copy editor frequently proves them wrong. Always be wary of numbers involving money, ages, dates, addresses, distance, performance records, statistical data and other compilations. If a number looks questionable, always refer it to the writer for verification.

A BM1 may be only 23 years old, but most likely he is 32. A seaman whose age is listed as 42 may really be 24. 'he JO who wrote the story may have hit the wrong keys on the keyboard Another story says that ET1 Jack Kelly was married four years ago. However, his children are mentioned and their ages are listed as 7 and 9. Readers will want to know why.

The beginning of a story may say that seven men were killed or injured in a plane crash, yet the casualty list may contain the names of only six. Readers will want to know what happened to the seventh name. A story may announce the opening of a new commissary on Monday, January 18. A check with your calendar, however, indicates that Monday, January 18 is Martin Luther King Jr. Day, and commissaries are not normally open on federal holidays.

Watch for the logic in statistical data. Double-check league standings to be sure the numbers of wins and losses balance. Do not use postal box numbers for addresses. People receive their mail in boxes. However, they do not live in them.

In general, spell out all numbers from one to nine, and use numerals for 10 and above. Numerals are used exclusively in tabular and statistical matters, records, election returns, times, speeds, latitude and longitude, temperatures, highways, distances, dimensions, heights, ages, ratios, proportions, military units and dates. Fourth of July and July Fourth are exceptions as are Fifth Avenue, Big Ten and Dartmouth Eleven.

Times are 6:30 p.m. Monday or 6:30 Monday evening. (**Never** use 6:30 p.m. Monday evening. Evening and p.m. are synonymous.)

In a series of numbers, apply the appropriate guidelines: There are three 10-room houses and 40



four-room houses in the development. He has six suits, 14 pairs of shoes but only one tie.

Casual numbers such as in the following examples are spelled out: A thousand times, no! Gay Nineties. Wouldn't touch it with a ten-foot-pole. However, numerals are used when using an exact measure as in the following example: The flag hung from a 10-foot pole.

Spell out fractions when used alone as in this example: Three-quarters of a mile. For amounts more than one, use numerals as follows: Her shoe size is 6 1/2. Convert to decimals whenever practical.

For further information, consult the latest edition of *The Associated Press Stylebook and Libel Manual*.

## SPELLING

If you think you know how to spell well enough to get along without a dictionary, try spelling the following 10 words (chances are, you will misspell a few of them):

- inoculate or inoculate
- embarrass or embarrass
- supercede or supersede
- larnyx or larynx
- interfered or interfered
- indispensable or indispensable
- laision or liaison
- diphtheria or diphtheria
- harass or harrass
- accommodate or accommodate

If you selected inoculate, embarrass, supersede, larynx, interfered, indispensable, liaison, diphtheria, harass and accommodate as the correct spelling, throw away your dictionary. But, if you misspelled one or more words, start using your dictionary regularly. These are only 10 examples of troublesome words in the English language. Of course, there are thousands more. Undoubtedly, you have your favorites when it comes to misspelling words. So, compile your own list of frequently misspelled words and start eliminating them from your list.

In mastering words, there are certain basic rules for spelling that will help you. Unfortunately, for every spelling rule there are numerous exceptions. Some

spelling rules have so many exceptions that they can just barely be classified as rules. The point to remember is that your dictionary is the final authority.

The most useful of the spelling rules and some examples and exceptions are listed as follows:

1. When a one-syllable word or a longer word that keeps the accent on the last syllable ends in a single consonant preceded by a single vowel, double the final consonant before adding a suffix beginning with a vowel.

### Examples:

- a. Clan, clannish
- b. Plan, planned, planning
- c. Control, controlled
- d. Refer, referring — but, reference (because the accent has shifted away from the last syllable of the basic word)
- e. Occur, occurred, occurrence

2. Words ending in a silent e generally retain this e before a suffix beginning with a consonant. When the suffix begins with a vowel, the silent e is usually dropped.

### Examples:

- a. Excite, excitement; late, lately
- b. Tide, tidal; shape, shaping

3. When the final sound of the word is a soft c, g or ng, the final e is retained before some suffixes beginning with vowels.

### Examples:

- a. Peace, peaceable
- b. Advantage, advantageous; courage, courageous
- c. Change, changeable, but changing

4. Words ending in y preceded by a consonant usually change the y to i before a suffix. Words ending in y preceded by a vowel do not change the y before a suffix.

### Examples:

Icy, iciest; mercy, merciless; modify, modifies, modifiable; pity, pitiable, pitiful

Obey, obeying; joy, joyful, joyous

5. When the sound is c, remember the rhyme, “i before e except after c...”

**Examples:**

- a. Believe, belief, relieve, relief
- b. Receive, conceive, perceive, conceit

**Exceptions:**

Weird, seize, neither, leisure, financier, inveigle.

6. The previous rhyme ends “. . . or when sounded as a as in neighbor or weigh.”

7. Verbs ending in ie generally change ie to y before ing.

**Examples:**

Die, dying; lie, lying

Learning to spell is more a matter of establishing a correct image of each word than of applying rules. Usually the image is a visual one. Knowing the correct pronunciation often helps, but in the English language we have many words for which pronunciation is no guide to spelling (e.g., duty, beauty, grew, blue), so we must rely on the way the word looks. While you are looking up an unfamiliar word, make an effort to fix its spelling in your mind along with the meaning and pronunciation.

## PUNCTUATION

Punctuation in writing serves the same purpose as voice inflection in speaking. Proper phrasing avoids ambiguity, ensures clarity and lessens the need for punctuation.

### Period

The period (.) serves the following functions as shown in each example:

- To mark the end of a sentence

**Example:** Close the door.

- To accentuate most abbreviations

**Examples:** U.S., c.o.d.

- To separate integral and decimal numerals

**Examples:** 3.75 percent, \$3.75, 3.75 meters

### Ellipsis

The ellipsis (. . .), three periods and two spaces, is used for the following functions as shown in each example:

- To indicate omitted material

**Example:** “I pledge allegiance to the flag . . . and to the Republic. . .”

### Comma

The comma (,) serves the following functions as shown in each example:

- To separate various elements within a sentence and to indicate a slight pause

**Examples:** When lightning struck, Bob Smith fainted. When lightning struck Bob, Smith fainted.

- To separate clauses

**Example:** They fought the battle, but no one won.

- To separate a series

**Example:** Neither snow, rain nor heat ...

- To set off attributions

**Example:** “The work,” he said, “was exacting and satisfying.”

- To set off apposition or contrast

**Example:** Wilson, the favorite, won handily.

As used in the following examples, the comma is omitted before Roman numerals, Jr., Sr., the ampersand (&), the dash, in street addresses and Social Security numbers.

**Examples:** Louis XIV, Joe James Jr., Smith &Co., 54321 Pine St., 123-45-6789.

Newspaper usage has, in most cases, eliminated the comma before “and” and “or” in a series, but a comma is still required before “and,” “or” and other conjunctions in compound sentences. Note the following example:

**Example:** Fish abounded in the lake, and the shore was lined with deer.

## Semicolon

As used in the examples that follow, the semicolon (;) separates phrases containing commas to avoid confusion, separates statements of contrast and statements closely related.

**Examples:** The party consisted of E. E. Wright; R. J. Kelly, his secretary; Mrs. Jordan; Martha Bowen, her nurse; and three accountants. (Without the semicolons, that could read as nine persons.) The draperies, which were ornate, displeased me; the walls, light blue, were pleasing. Yes; that is right.

## Colon

As used in the following examples, the colon (:) precedes the final clause and summarizes previous material; introduces listings, statements and texts; marks discontinuity; and takes the place of an implied “for instance.”

**Examples:** States and funds allotted were as follows: Alabama \$6,000, Arizona \$14,000. The question came up: What does he want to do?

The colon also is used in the following reamers and examples:

- In clock time

Examples: 9:20 p.m., 10:30 a.m.

- In Biblical and legal citations

**Examples:** Matt. 2:14, Missouri Statutes 3:234-432

## Question Mark

The question mark (?) follows a direct question. Occasionally, it is used to indicate uncertainty, as with some dates or identifications. In the latter use, it is enclosed in parentheses. Note the following examples:

**Examples:** What happened to Dean? Columbus, an Italian (?) sailing for the Spanish crown, discovered America...

## Exclamation Point

The exclamation point (!) is used to indicate surprise, appeal, incredulity or other strong emotion as in the following examples:

Examples: You are wonderful! What! He yelled, “Help!”

## Apostrophe

The apostrophe (') indicates the possessive case of nouns, omission of figures and contractions. Usually, the possessive of a singular noun not ending in “s” is formed by adding the apostrophe and the “s” as in the example that follows:

**Example:** The boy’s ball, but the boys’ bats.

The apostrophe is used in the following instances and examples:

- After plural possessives

**Examples:** the girls’ coats; the marines’ rifles.

- In contractions

**Examples:** I’ve, isn’t, don’t.

- In omission of figures

**Examples:** ’90s, Class of ’22.

The “s” is omitted and only the apostrophe used in “for conscience’ sake” or in a sibilant double or triple “s” as Moses’ tablet.

As in the following examples, the apostrophe is not used to form plurals unless it is in the context of the exception shown:

**Examples:** MiGs, P-3s, B-52s, ABCs.

**Exception:** When a single letter is made plural, as in “mind one’s p’s and q’s,” the apostrophe is required.

## Quotation Marks

Quotation marks (“ ”) enclose direct quotations, phrases in ironical uses, slang expressions, misnomers and full titles of books, plays, poems, songs, lectures, speeches, hymns, movies, television, and so forth.

As in the next example, use quotation marks around nicknames when a person’s full name is used.

**Example:** Paul “Bear” Bryant.

Note the following examples in which the comma and period are placed inside the quotation marks. Other punctuation is placed inside quotation marks only when it is part of the matter quoted.

**Examples:** Why call it a “gentlemen’s agreement”? He asked, “Is the interview completed?”

## Parentheses

Parentheses ( ) serve the following functions as shown in each example:

- To set off material not intended to be part of the main statement or that is not a grammatical element of the sentence, yet important enough to be included

**Examples:** It is not customary (at least in the areas mentioned) to stand at attention. “That proposal,” he said, “and one by (Prime Minister John) Major are being studied.”

- To facilitate further identification that is not part of the official name

**Example:** The Springfield (Virginia) Historical Society.

- To set off letters or figures in a series

**Examples:** The order of importance will be (a) general acceptance, (b) costs and (c) opposition. The water is (1) tepid, (2) muddy from silt and (3) unpalatable.

## Dash

As shown in each example, the dash (—) is used in the following cases:

- To indicate a sudden change and interjection

**Examples:** The commander—do you know who I mean? — approved it. If that man gains control — God forbid — our troubles will have just started

- After dateline and before the first word of a story

**Example:** NEW YORK — five people were injured. ...

Note that a dash consists of two strokes of the hyphen (or minus sign) key on your computer keyboard.

## Hyphen

The hyphen (-) is used to separate compound words, figures, abbreviations and figures, double vowels in some cases and to divide a word at the end of a line.

The general rule for hyphens is that “like” characters take the hyphen; “unlike” characters do not. Note the following examples:

**Examples:** Secretary-Treasurer (compound word); 20-20 vision (figures); bell-like (use a hyphen to avoid tripling a consonant).

Other uses of the hyphen and examples are as follows:

- Adjectival use of hyphens must be clear.

**Examples:** The 6-foot man eating shark was killed (the man was). The 6-foot man-eating shark was killed (the shark was).

- Ordinarily, in prefixes ending in vowels and followed by the same vowel, the hyphen is used.

**Example:** pre-eminent. (Check dictionary for exceptions ‘such as cooperate, coordinate, etc.)

- The hyphen also serves to distinguish between meanings of similarly spelled words.

**Example:** recover (from illness), re-cover (couch).

- The hyphen separates a prefix from a proper noun.

**Examples:** un-American, pre-Christian era

**Do not** use a hyphen between “vice” and “president” or other such titles, or with adverbs ending in “ly.” Note the following examples:

**Examples:** badly damaged car, frilly informed public, newly elected official.

## CAPITALIZATION

In newswriting, capitalization is correct in the following cases, examples and exceptions:

- The first word of a sentence

**Example:** Good grammar is essential.

- Titles and ranks (rates) followed by a proper noun, but lowercase titles standing alone or following a name

**Example:** Secretary of State C. R. Dryden, but C. R. Dryden, secretary of state.

**Exception:** The President of the United States is always capitalized.

- Pope and the titles of foreign religious leaders, when used as a formal title before a name, but lowercase when titles stand alone or follow names

**Exception:** Dalai Lama is capitalized in all usages, since that title is used instead of the name of the person holding that office.

- Months and days, but not seasons

**Example:** Last summer our vacation began on the first Thursday in August.

- All holidays, historic dates, religious holidays, special events, military exercises, hurricanes and typhoons

**Examples:** Christmas, Father's Day, Washington's Birthday, National Safety Week, Operation Desert Storm, Typhoon Gay, Hurricane Andrew.

- All proper nouns or names

**Examples:** Marty Martin, Bangkok, Hudson River.

- All names of countries and their languages, unions, republics and colonies

**Examples:** He learned to speak French in France. India is a former British colony. Other examples are Union of South Africa and Republic of Korea.

- Specific regions

**Examples:** Middle East, Midwest, Southern California, Panhandle, Arctic Circle, but lowercase antarctic or arctic in reference (arctic wind).

- Appellations

**Examples:** Buckeye State, Leatherneck Project Apollo.

- All decorations and awards

**Examples:** He was awarded the Medal of Honor. His father received the Nobel Peace Prize. She was awarded the Navy Achievement Medal for professional achievement.

- All nouns referring to the deity of all monotheistic religions

**Examples:** God the Father, Holy Ghost. Also capitalize Satan and Hades, but not devil or hell. Lowercase gods and goddesses in reference to the deities of polytheistic religions.

- Names of races

**Examples:** Indian, Chinese, Caucasian. Lowercase yellow, white, black (Identification by race should be made only when it is pertinent.)

- The first letter of each word, except articles, conjunctions and short prepositions that are not the first word, in titles of books, plays, hymns, poems and songs

**Examples:** "All the Ships at Sea," "Damn Yankees," "O' Come All Ye Faithful."

- U.S. government and state government agencies, branches, committees and departments when the full name is used

**Examples:** Federal Communications Commission Interstate Commerce Commission. In addition, always capitalize U.S. Congress and U.S. or state Senate, House, and Legislature when referring to a specific body.

**Examples:** the Florida Senate, the Texas Legislature and the Senate, when clear reference is made; the word government, when used alone or with an adjective, is lowercase. Example: She works for the government.

- Ideological or political areas

**Example:** East-West relations are at a stalemate. Use lowercase when referring to direction.

**Example:** Some say the western part of Florida has nicer beaches than the eastern part.

- Names of organizations, expositions, and so forth

**Example:** The Boy Scouts will visit the World's Fair. Lowercase "scout" and "fair" when they are standing alone.

## ABBREVIATIONS

To abbreviate is to make a word or phrase shorter by leaving out or substituting letters. Some military and civilian terms are so long that abbreviation is almost a must. However, always spell out the name of organizations or groups on its first use. If a name does not have a commonly known abbreviation, the abbreviation should be parenthesized after the first spelling. Thereafter, you may use just the abbreviation as in this example: The guidelines of the Civilian Health and Medical Program of the Uniformed Services (CHAMPUS) have changed. ...

The abbreviations that follow and those used throughout this TRAMAN are basically those standardized for civilian and military newswriting by The Associated Press and United Press International.

In newswriting, abbreviate the following and note the examples of each:

- Time zones, aircraft and ship designations, distress calls, military terms, and so forth

**Examples:** EDT, MiG-17, SOS (but May Day), USS *John F. Kennedy*, SS *Virginia*.

- Business firms

**Examples:** Warner Bros., Brown Implement Co., Amalgamated Leather, Ltd. If “and” is in the firm name, use the ampersand (&). **Examples:** Sims & Sons, AT&T.

- Street, avenue, boulevard and terrace in addresses when using a numerical prefix, but not point, port, circle, plaza, place, drive, oval, road or lane

**Examples:** 30 E. 28th St. (single “E” with period), 16 Quentin Ave. NW (no periods in “NW”), 27 Sunset Blvd., but Main Street, Fifth Avenue, and so forth

- Versus to read vs. (with period)

**Example:** The case of Johns vs. New York.

- Most states when used with cities, towns, bases, Indian agencies and national parks

**Examples:**

Ala.	Md.	N.D.
Ariz.	Mass.	Okla.
Ark	Mich.	Ore.
Calif.	Minn.	Pa.
Colo.	Miss.	R.I.
Conn.	Mo.	S.C.
Del.	Mont.	S.D.
Fla.	Neb.	Tenn.
Ga.	Nev.	Vt.
Ill.	N.H.	Va.
Ind.	N.J.	Wash.
Kan.	N.M.	W.Va.
Ky.	N.Y.	Wis.
La.	N.C.	Wyo.

Do not abbreviate Alaska, Hawaii, Idaho, Iowa, Maine, Ohio, Texas or Utah. Never abbreviate the name of states when they are used alone.

- Names of provinces and territories are set off from community names by commas, just as the names of U.S. states are set off from city names

**Example:** They went to Halifax, Nova Scotia, on their vacation.

- United Nations and United States when used as adjectives, but spell them out when used as nouns. In texts or direct quotations, U.S.A., U.S. and U.N. maybe used as nouns

**Examples:** He is a former U.S. Olympic champion. She is a member of the U.N. Educational, Scientific and Cultural Organization (UNESCO). While visiting the United States, she toured the United Nations Building in New York. “When last I was in the U.S.A., the U.N. was in its infancy.”

- All religious, fraternal, scholastic or honorary degrees, and so forth, but lowercase when spelled out

**Examples:** J. J. Jones earned his bachelor of science degree at Princeton. J. J. Jones, Ph.D., will be guest speaker at 2 p.m. tomorrow.

- Titles (and capitalize) Mr., Mrs., Mile., Dr., Prof., Sen., Rep., Dist. Atty., Gov., Lt. Gov., Gen., Supt., and so forth, when they appear before names but not after

**Examples:** He introduced Lt. Gov. J. F. Petty. J. F. Petty, the lieutenant governor, will arrive at 10:15 a.m. In first and subsequent references and in group names, use “Miss” before the name of an unmarried woman and “Mrs.” before the name of a married woman, or “Ms.” if preferred by the individual. Example: Those attending were, Miss Alice Jones, Mrs. Helen Jones and Ms. Gladys Jones.

- Months when used with dates, but spell out otherwise

**Example:** The battle started Oct. 10, 1967, and ended in January 1968. Abbreviations for months are Jan., Feb., Aug., Sept., Oct., Nov., Dec. Do not abbreviate March, April, May, June or July except when used in tabular or financial routine; then use Mar., Apr., Jun. and Jul. and spell out May

- Mount when referring to a mountain but spell out when referring to a city

**Examples:** Mt. Everest, Mount Vernon, N.Y.

- Fort when it is an Army post, but spell out when it is a city

**Examples:** Ft. Sill, Fort Lauderdale, Fla.

In the following cases, **do not** abbreviate and note the accompanying examples and exception:

- Days of the week except in tabular or financial matters. In these cases use Mon., Tues., Wed., Thurs., Fri., Sat., Sun.

- First names unless the person does

**Examples:** William, not Wm.; Frederick, not Fred; Benjamin, not Benj.

- Measurements — The one exception to this rule is the word millimeter, which maybe abbreviated as mm (no space) when used with a numeral in first or subsequent references to film or weapons. Miles an hour and miles per hour are abbreviated in subsequent reference only and must have a numerical prefix

**Examples:** He used a 35mm camera. She was driving 60 miles an (per) hour but slowed down to 30 mph in the housing area.

- Port, association, point, detective, department, deputy, commandant, commodore, field marshal, secretary-general, secretary or treasurer
- Christmas or use Xmas
- Cities

**Exception:** Saint is abbreviated to St., when it is part of a city name. **Example:** St. Augustine, Fla. These well-known cities are used without a state suffix:

Atlanta	Houston	Philadelphia
Baltimore	Indianapolis	Phoenix
Boston	Las Vegas	Pittsburgh
Chicago	Los Angeles	St. Louis
Cincinnati	Miami	Salt Lake City
Cleveland	Milwaukee	San Antonio
Dallas	Minneapolis	San Diego
Denver	New Orleans	San Francisco
Detroit	New York	Seattle
Honolulu	Oklahoma City	Washington

## MILITARY TERMS

One of the chief complaints of civilian editors concerning military journalism is the excessive use of abbreviations for titles and organizations. In the majority of cases, most people within a particular service will know most of its standard abbreviations. However, many will not know them all, particularly family members, visitors and new service personnel.

Titles and organizational designations should always be spelled out in the first reference — except those that are so well known that it would be a definite waste of space.

All foreign services should be lowercased and spelled out; for example, French army. Military jargon and colloquial expressions should be avoided unless they are used in proper context or direct quotes. When possible, eliminate abbreviated terms to differentiate between a professionally written news article and a set of travel orders. Some examples of military abbreviations that you should not use in news stories include the following:

- TAD (temporary additional duty)
- R&R (rest and recreation)
- RON (remain overnight)
- OOD (officer of the day (deck))
- PCS (permanent change of station)

When you refer to members of a particular service, use the following collective terms:

- Soldier (a member of the U.S. Army)
- Sailor (U.S. Navy)
- Marine (U.S. Marine Corps)
- Airman (U.S. Air Force)
- Coast Guardsman (U.S. Coast Guard)
- Guardsman (Army or Air National Guard)

For military rank and title abbreviations, by service, consult the latest edition of *The Associated Press Stylebook and Libel Manual*.

Thousands of doctors, nurses, veterinarians, dentists, chaplains and lawyers serve the military in their respective professional capacities. As such, they should be identified in news stories by their profession. This identification should be made in the first reference. Note the following examples:

**Examples:** Capt. (Dr.) Joe Johns of the Portsmouth Naval Hospital conducted . . . Cmdr. Edna Knox, Navy Nurse Corps, told medical authorities . . . Maj. (Dr.) Larry Riley, a veterinarian, stressed the importance . . . Navy Chaplain (Cmdr.) John Frisby will preside over ... (**Note:** A chaplain's rank is enclosed in parentheses. In the previous example, subsequent references would be Chaplain Frisby.)

Lawyers are not identified by profession in the military service per se. However, in all possible cases, they should be referred to in relation to their role in the story. Consider the following example:

**Example:** Coast Guard Lt. Henry Smith, the defense attorney (trial lawyer, staff judge advocate, etc.), a member of the Maryland Bar Association, moved for a dismissal of the charges.

In many cases, news stories require the use of a person's service in addition to name and rank, particularly in joint maneuvers. When this occurs, place the service identifier before the rank and name as in the following examples:

**Examples:** Navy Capt. Rob Rogers; Coast Guard Lt. Jim King; Air Force Maj. Richard Johnson. (The "U. S." before Amy, Navy, Air Force, "Coast Guard or Marine Corps is optional unless tied in with foreign dissemination.)

Women, military as well as civilian, should receive the same treatment as men in all areas of news coverage. Never use sexist references, demeaning stereotypes and condescending phrases in reference to women. The same standards for men and women should be used in deciding whether to include specific mention of personal appearance, physical description or marital and family situation.

As in the following examples, aircraft, ships and other military equipment should be identified by popular name and model designation.

**Examples:** The Air Force Lockheed C-141 *Starlifter* flew. ... Each soldier carried an M-79 grenade launcher. ... The aircraft carrier USS *Lexington* (AVT 16), "Lady Lex," was opened as a floating museum. ...

## RELIGIOUS TERMS

There is only one way to refer to confessions of faith, their members and officials — the correct way. While general usage and correct titles of some of the faiths are listed below, many are not. When in doubt, consult your chaplain's office. Members of communions of the National Council of the Churches of

Christ in the United States of America (official title, which may be shortened to National Council of Churches) are as follows:

African Methodist Episcopal Church  
African Methodist Episcopal Zion Church  
American Baptist Convention  
American Lutheran Church  
Antiochian Orthodox Christian Archdiocese of North America  
Armenian Church of America  
Christian Church (Disciples of Christ)  
Christian Church of North America, General Council  
Christian Methodist Episcopal Church  
Friends United Meeting (Five Years Meeting)  
Greek Orthodox Archdiocese of North and South America  
Hungarian Reformed Church in America  
Moravian Church  
National Baptist Convention of America  
National Baptist Convention U.S.A. Inc.  
Orthodox Church in America  
Polish National Catholic Church of America  
Presbyterian Church in the U.S.  
Progressive National Baptist Convention Inc.  
Protestant Episcopal Church  
Romanian Orthodox Episcopate of America  
Seventh-Day Adventist  
Southern Baptist Convention  
Ukrainian Orthodox Church of the U.S.A.  
United Church of Christ  
Lutheran Church in America  
United Methodist Church  
United Presbyterian Church in the U.S.A.

Other communions include the following:

Churches of Christ  
Church of Christ, Scientist  
Church of Jesus Christ of Latter-day Saints



Jehovah's Witnesses

Religious Society of Friends

Roman Catholic Church

Unitarian Universalist Association

Jewish groups include the following:

Union of American Hebrew Congregations

Union of Orthodox Jewish Congregations in America

United Synagogues of America

Rabbinical groups include the following:

Central Conference of American Rabbis

Rabbinical Assembly of America

Rabbinical Council of America

Union of Orthodox Rabbis of the United States and Canada

The Synagogue Council of America represents both the congregational and rabbinical groups of Orthodox, Reform and Conservative Judaism. Their places of worship are temples or synagogues. The generic term is Jewish house of worship.

In general written reference to a member of the clergy, use the following: the Rev. John Smith, or the Rev. Mr. Smith. Do not use Rev. without Mr., Miss, Mrs., Ms., a first name or initials. A chaplain is referred to as a chaplain with his rank following in parentheses on the first usage. Note the following examples of the correct use of titles:

**Example:** Chaplain (Lt.) John Smith . . . then, Chaplain Smith.

The title "Dr." is used only when the doctorate degree is actually held.

**Examples:** the Rev. Dr. Betty Johns; Dr. Johns; The Rev. Betty Johns, D.D. (Doctor of Divinity).

Roman Catholic usage: the Rev. Joe Jones; Father Jones; the Most Rev. Joe Jones, bishop of the Denver Diocese; Bishop Jones; Francis Cardinal Jones; Cardinal Jones.

A nun is addressed as "sister," which is capitalized in all references before her name. When a surname is given in the first reference, use both given name and surname (Sister Mary Elizabeth Smith); and in subsequent references, use only the surname (Sister Smith). When the surname is not provided, the name is

the same in all references (Sister Mary Elizabeth). Do not abbreviate the word "sister."

Episcopal usage: A priest is referred to as the Rev. John Jones or the Rev. Mr. Jones. A dean is the Very Rev. John Jones, the Rev. Jones, Mr. Jones or Dean Jones. A bishop is the Rt. Rev. John Jones, the Rt. Rev. Mr., or Bishop Jones. A member of the Episcopal Church is an Episcopalian.

Jewish usage: Rabbi John Goldstein, Rabbi Goldstein, Dr. Goldstein (where degree is held). Cantor John Goldstein, Cantor Goldstein. Never identify a rabbi as Reverend Doctor.

Christian Science usage: Practitioner, Lecturer, Reader Joe Jones. Never "reverend" in any form. Reader Jones of the First Church. The Mother Church (Boston church only).

Methodist usage: Pastor, minister, preacher, bishop. Use of the Rev. Mr. Jones is acceptable.

Lutheran usage: In the United States — Pastor John Jones, Pastor Jones, Mr. Jones. Scandinavian Lutheran usage follows the Episcopal forms.

Latter-Day Saints (Mormon) usage: President John Jones, President Jones, Elder Jones, Presiding Bishop John Jones, Bishop Jones, Presiding John Jones of the Presiding Bishopric. Members of the church are Mormons.

It is incorrect to apply the word church to any Baptist unit except the local church. The organization of Southern Baptists is the Southern Baptist Convention.

The American Lutheran Church, the Evangelical Lutheran Church and the United Evangelical Lutheran Church merged in 1960 into the American Lutheran Church with headquarters in Minneapolis, Mire.

Unitarian and Universalist denominations are known as the Unitarian Universalist Association.

There are other faiths that have mosques, dioceses, archdioceses, areas, synods, presbyteries, and so forth. If in doubt, you should consult your chaplain's office for the accurate designations and changes.

## COMMON SENTENCE STRUCTURE ERRORS

*LEARNING OBJECTIVE: Recognize the common errors in sentence structure.*

The sections on spelling, capitalization and punctuation have all contributed to the construction of

good sentences. However, to be effective, sentences must be grammatically correct. In addition, they should be well-chosen and effectively combined with a goal of clarity, emphasis and interest. These goals are often thrown off target by any one of a variety of common errors in sentence structure.

## SENTENCE FRAGMENTS

In terms of grammar, writers are frequently at fault for writing incomplete sentences. For a sentence to express a complete thought, it must contain two necessary parts — a subject and a predicate, or verb. It is possible, of course, for the subject to be understood, rather than stated, but you should be sure in such cases that it is clearly implied.

Some examples of incomplete sentences include the following:

- The sightseeing tour, which was arranged for the liberty party. (There is no main verb. The relative clause has a verb, “was arranged,” but what appears to have been intended as a statement with “sightseeing tour” as subject has not been completed.)
- A tall, thin man with owlish spectacles and a bald head. (The verb is omitted.)
- Floated toward the beaches. (Here the subject is omitted. What floated?)
- Just as the searchlight swept across the harbor. (This tells when something happened, but the main statement is still incomplete.)
- Bailey, the new striker, looking as if he would burst-with pride. (There are modifiers here for the subject, “Bailey,” but no main statement about that individual.)

Often an incomplete sentence results from the writer’s failure to recognize that a modifying phrase or clause is really part of the preceding sentence. For instance, a comma should be used instead of the first period in the following example:

- The cruiser was headed for the canal zone.  
Steaming eastward through the Caribbean.

The result in this case is one complete sentence instead of a sentence followed by a fragment.

You should not be misled by the fact that some writers deliberately construct incomplete sentences at times. As the late Emily Post once said about etiquette:

“Well-bred persons sometimes break some of the rules; but to break them and getaway with it, you first have to know them.”

It is true that fractured sentences may occasionally produce the desired effect, but be sure you know why they are being used and that they are suitable to what is being written. Many regard a sentence that begins with “but,” or another connective, as incorrect, largely because the connective standing first seems to indicate a fragment. In this instance, the rule may be ignored occasionally, if by doing so you achieve a more effective statement.

## RUN-ON SENTENCES

Another common error in sentence structure is the punctuation of two or more sentences as if they were one. This usually occurs with sentences that are closely related in thought. Note the following examples:

**Poor:** The ship held its first swim call, the water was 4 miles deep.

**Improved:** The ship held its first swim call. The water was 4 miles deep.

Often a run-on sentence is the result not only of faulty punctuation, but of the writer’s failure to think the construction through and recognize the relationships of the various ideas. Consider the following examples:

**Poor:** Detailed decontamination is a lengthy process, it is usually carried on at a home base or rear area.

**Improved:** Detailed decontamination is a lengthy process, usually carried on at a home base or rear area.

**Poor:** An emergency tourniquet can be made from something like a neckerchief, it is wrapped once around the limb and tied in an overhand knot.

**Improved:** To apply an emergency tourniquet made from something like a neckerchief, wrap the material once around the limb and tie an overhand knot.

## DANGLING MODIFIERS

A writer’s misplacement of a modifier can confuse the meaning of the sentence, often with ludicrous results. Modifiers should be positioned close to the words they modify; otherwise, they may seem to modify something else. Haste, carelessness or lack of

understanding of grammar may cause a writer to use a construction without thinking exactly what a particular word is supposed to modify. This kind of error is fairly common in using participles with other adjectives or with adverbial modifiers, as in the following examples:

**Dangling Participle:** Returning to the ship, the package was found on his bunk.

**Improved:** Returning to the ship, he found the package on his bunk. (It was he who returned to the ship, not the package.)

**Dangling Participle:** Entering the halon-flooded compartment, the gas overcame him.

**Improved:** Entering the halon-flooded compartment, he was overcome by the gas.

**Dangling Participle:** Running rapidly out from the windlass, he caught his foot in the anchor chain.

**Improved:** He caught his foot in the anchor chain, as it ran rapidly out from the windlass.

**Misplaced Prepositional Phrase:** At the age of two his father died.

**Improved:** He was two years old when his father died.

**Misplaced Prepositional Phrase:** Baker saw the driver of the car that had hit him in the theater.

**Improved:** In the theater, Baker saw the driver of the car that had hit him.

**Misplaced Relative Clause:** The chief mess management specialist discovered that old baking powder had been used in the biscuits, which caused all the trouble.

**Improved:** The chief mess management specialist discovered that the trouble with the biscuits was the use of old baking powder.

A frequently misplaced word is “only.” By moving this one word around in a sentence, you can change the meaning entirely. Study the following example:

- Only he could read the strange dialect.  
(Nobody else could.)
- He could only read the strange dialect.  
(He could not write or speak it.)
- He could read only the strange dialect.

(He could read nothing else.)

- He could read the only strange dialect.

(Only one dialect was strange, and he could read it.)

## MISPLACED CORRELATIVE CONJUNCTIONS

Correlative conjunctions, (such as **not only — but also** and **either — or**) are often misplaced. Their correct position is just ahead of the words or groups of words they connect. Consider the following examples:

**Misplaced:** The Navy letter form **not only** omits the salutation **but also** the complimentary close. (The words that should be connected are “salutation” and “complimentary close”.)

**Correct:** The Navy letter form omits **not only** the salutation **but also** the complimentary close.

**Misplaced:** **Either** secure lines to the arresting hook or the hoisting sling. (As this sentence stands, the words that should be connected are “arresting hook” and “hoisting sling.” The sentence will be better, however, if two complete prepositional phrases are used instead.)

**Correct:** Secure lines **either** to the arresting hook or to the hoisting sling.

Other frequently used correlative conjunctions are “both — and,” “neither — nor” and “whether — or.”

## SPLIT INFINITIVES

Splitting an infinitive means placing one or more modifiers between the “to” and the verb form. You will hear people say that a split infinitive is no longer regarded as incorrect, but that is only a partial truth. Some writers consider that splitting an infinitive is desirable at times for the sake of emphasis; for example, “To **deliberately** disobey an order is a serious offense.” Even this sentence will grate on some ears, and generally, it is better for you to keep the adverb outside the infinitive construction. That is especially true when you have more than one adverb or a phrase.

**Awkward Split:** The only way for a person to win against a fire is **to** regularly and thoroughly **practice** the rules of fire prevention.

**Better:** The only way to win against a fire is to **practice** rules of fire prevention regularly and thoroughly.

## ERRORS IN AGREEMENT

You probably have no trouble, most of the time, with agreement of verb and subject. You are not tempted to write: “The propellers was damaged.” But how about, “The propeller and shaft was damaged”? Wrong, to be sure, but it is an easy mistake to make when you are thinking of the two parts of a compound subject as belonging together. It should, of course, read “The propeller and shaft **were** damaged.”

In a compound subject with “or” or “nor” as a connective, the verb should agree in number with the last noun in the subject.

**Incorrect:** Neither the propellers nor the rudder **are** damaged.

**Correct:** Neither the propellers nor the rudder **is** damaged.

When a parenthetical expression beginning with words such as “together with,” “with” or “including” comes between the subject and the verb, there is a temptation to make the verb plural as if the subject were compound. Consider the following example:

**Incorrect:** One mast, together with a spar running athwartship, **are** used for flags.

correct: One mast, together with a spar running athwartship, **is** used for flags.

Disagreement between subject and verb sometimes occurs because, in a complicated sentence, a nearby noun is mistaken for the subject. This is the case in the following example, in which the plural nouns “officers” and “commands” seem to have confused the writer. The subject of the sentence, however, is “duty.”

**Incorrect:** The primary duty of such staff dental officers serving in these commands **are** very similar to those of a district dental officer.

**Correct:** The primary duty of such staff dental officers serving in these commands **is** very similar to that of a district dental officer.

**Correct:** The primary duties of such staff dental officers serving in these commands **are** very similar to those of a district dental officer.

## GERUNDS

A gerund is a verb (verb form) used like a noun. For example: **Running** is good exercise. A gerund retains

some of its verb qualities, however, such as taking a subject or object, or being modified by adverbs. Only one of these verb qualities — taking a subject — differs from what would be used with the same verb if complete. The subject of a gerund is in the possessive case instead of the nominative. For example: Had you heard about his **passing** the test?

“Passing” is a gerund with “his” as the subject and “test” as the object. The complete phrase is used here as the object of the preposition “about.”

## ERROR IN NOUN CLAUSES

The pronoun that introduces a noun clause is sometimes given the wrong case because of the writer’s failure to recognize the structure of the sentence. The case of any pronoun is determined by its use in the clause of which it is apart. Note the following examples:

**Incorrect:** The award will go to **whomever** submits the best entry.

**Correct:** The award will go to **whoever** submits the best entry.

“Whoever submits the best entry” is a noun clause. The whole clause is used as the object of the preposition “to.” “Whoever” is the subject of the clause and therefore nominative.

## COPY-EDITING MESSAGE RELEASES AND NEWSWIRE COPY

*LEARNING OBJECTIVE: Identify the methods used in copy editing message releases and newswire copy.*

A **message** is an official communication in brief form transmitted by rapid means such as telegraph, radio, flashing light, flaghoist or semaphore. A message is usually received by a command’s communications department, reproduced, then distributed to staff members of departments concerned. It is tersely written, contains many abbreviations and is printed in capital letters.

However, when operations and time permit, timely news releases are transmitted in news style and contain all the information necessary for a good news story. Sentences are grammatically complete, including the necessary articles, adjectives and adverbs. A good message news release is very similar to newswire copy as it arrives in a radio, television or newspaper newsroom. It requires only copy editing and duplicating to get it ready for release to news media.

~~FR. COMSECONDFLT~~  
~~ACTION. CINCLANTFLT~~  
~~PRESREL 051500Z JUL 93 U.S./FRENCH EXERCISE~~  
~~FOLLOWING PRESREL PASSED FOR IMMEDIATE RELEASE X QUOTE~~ WITH THE  
SECOND FLEET AT SEA -- ELEMENTS OF THE SECOND FLEET AND PLANES  
 FROM FLEET AIR WING (ELEVEN) ARE ENGAGED WITH UNITS OF THE FRENCH  
ATLANTIC FLEET IN JOINT AIR, SURFACE, AND SUBSURFACE OPERATIONS  
 IN THE WESTERN ATLANTIC (X) PARTICIPATING U.S. VESSELS ARE THE  
 CARRIER RANDALL E. CEDILLA, GUIDED MISSILE FRIGATE MACRON, GUIDED  
 MISSILE DESTROYERS OGONEK, CARON AND POLLY N. ANNISH AND THE  
 SUBMARINE JACK CREVALLE (X) THE FRENCH UNITS WILL DEPART FOR HOME  
 AT THE COMPLETION OF THE EXERCISE (X) ENROUTE, THEY WILL CONDUCT  
 ANTI-SUBMARINE WARFARE TRAINING WITH A NEW DETACHMENT OF U.S.  
 SHIPS FROM DESTROYER SQUADRON (TWENTY-FOUR) (X) <sup>THIS GROUP WILL</sup> THEY WILL INCLUDE THE  
 GUIDED MISSILE FRIGATE RUPRECT, <sup>THE</sup> DESTROYERS CARNEY, FORREST E.  
BROOKS, ROECHETAL AND SEADOG, <sup>THE</sup> AND SUBMARINE SERGEANT (X)  
~~BT~~

- END -

Figure 6-3.—Copy-edited message news release.

A message news release is designated by the acronym PRESREL, which is a standard Navy communications abbreviation for press release. In the same line as PRESREL are the date and time (date-time group) the release was transmitted. For example: PRESREL 211802Z JUL93. In this case, the story was sent on the 21st day of July, 1993, at 1802. The "Z" represents Greenwich Mean Time. The use of a different letter here would indicate local time in the area where the story originated.

All message releases are for immediate release unless otherwise designated. Occasionally, circumstances

may dictate the use of such releasing instructions as: HOLD FOR RELEASE UNTIL (date and time), FOR SECURITY REVIEW AND RELEASE or FOR SIMULTANEOUS RELEASE. (Here, fill in the appropriate data.)

Because message news releases arrive printed in capital letters, you use a different system for copy editing. You must assume that all the capital letters are lowercase and begin your copy editing from there. In other words, any time you want to capitalize a letter you must underscore it three times. An example of a copy-edited message news release appears in figure 6-3.



## CHAPTER 7

# GATHERING AND DISSEMINATING NAVY NEWS

To gather and disseminate news, you must first know what news is and how and whereto find it.

News is new information about anything. **It** is material previously unknown (or at least unpublished) that the public, in whole or in part, needs or wants to know. News also can be thought of as information that someone or some group, such as the Navy, wants the public to know.

A fundamental definition of news — a key part of newswriting — is basic to a journalist's understanding of the craft. Some think of news as a combination of the compass points: north, east, west and south. Although this is not strictly the beginning of the term, the idea does emphasize the broad dimension the field covers. News is everywhere.

The primary commodity of the mass media is news. This commodity is mass-produced by world events and is retailed in printed, pictured and spoken form to millions of customers. As a Navy journalist you are a middleman for this commodity. However, you handle only the portion known as Navy news.

In Chapter 2, you learned what news is and the ways in which it is presented to the public. In this chapter, you will learn the types of news sources and the methods used to obtain and distribute news.

### TYPES OF NEWS SOURCES

*LEARNING OBJECTIVE: Identify the types of news sources used in producing and disseminating Navy news.*

For an energetic and resourceful journalist, the avenues for finding news stories are limitless. In reality, however, you will find that your job in the Navy does not afford you the luxury of spending days, or even hours, tracking down elusive leads that may eventually result in one story.

As stated in Chapter 1, the Navy journalist is a public information specialist, and not a free press journalist. Your job is to tell the Navy story. That means you must write positive copy about your command and its people (save adverse news situations). You are

employed by the Navy. Therefore, you are expected to **work** for the Navy.

This is especially true regarding a ship or station newspaper to which you may be assigned. Such publications may be compared with the house organs of civilian businesses covered in Chapter 4. Their purpose is to inform, educate and entertain their readers and to provide a means of recognizing the achievements of the personnel in the organizations they represent. They are not intended as forums for exposes.

### WRITTEN COMMUNICATIONS

When performing your job as Navy journalist, you will find that there are three primary sources of Navy news. They are as follows:

- Messages, directives and official correspondence
- Special contracts (both official and unofficial) maintained by the public affairs officer and his or her staff
- The future file

Information about practically every significant event that occurs in the Navy is passed on to those concerned via messages, directives or official correspondence. This includes news of coming events; current fleet exercises and operations; collisions at sea; search, rescue and salvage operations; plane crashes; acts of heroism; weather warnings and unusual weather conditions; changes of command; personnel promotions; new performance records; participation of Navy teams in athletics; upcoming charity drives and countless other occurrences.

#### Messages

Messages are transmitted between commands by rapid means, such as radio, teletype and flashing light. When a message arrives aboard ship or at a shore activity, a number of copies are made and distributed to various departments. The PAO normally gets copies of all message traffic that might be of interest in carrying out PAO duties.

Information contained in a message is usually brief and tersely written. The information is seldom detailed enough to be used for writing a comprehensive story. However, the basic facts are included and they provide a good starting point for you to develop a story.

## **Directives**

Directives provide another source of Navy news for release to the civilian news media. You will find that much of the information they contain is intended for use by Navy personnel. Information about pay and allowances, uniform changes, advancements and promotions, service members' and dependents' benefits, training and educational programs, new regulations, morale, leadership, charity drives and similar subjects are put out in directive form. When analyzed and written in news story form to play up local interest or some other news peg, information of this type makes good copy for command newspapers and other publications written primarily for a Navy-oriented audience.

## **Official Correspondence**

Official correspondence between commands often provides tips for worthwhile stories. An aviation machinist's mate first class, for example, submits an idea to the Naval Air Systems Command via the chain of command about an Improved method for servicing aircraft. The idea is tested and adopted, and the individual is commended for the initiative and ingenuity shown. The entire transaction takes place on paper in the form of official correspondence. If copies of the letters are routed to the PAO for information, you will have an opportunity to develop a good story for internal and external release if the facts are unclassified

Security is an important factor for you to consider before using any information available in naval messages, directives and official correspondence for a news release. If the material is classified, you must not use it.

## **SPECIAL CONTACTS**

Every public affairs office depends on tips from outside sources to develop stories. Regardless of the size of a command, it is impossible for you to know everything that is going on. By creating a list of special contacts, both officials and personal friends, and acquainting them with your job, you will assure yourself of having a steady flow of news items. Although a stranger may be reluctant to telephone your office and

suggest a story, a friend or an acquaintance will feel free to call.

Officially, you should at least know the name, rank and title of every senior officer in your command. You should also have a good idea of the type of work they do and where they can be reached when you need information. If you remain in your job long enough, you will probably have personal contact with them. If you show them you are an efficient and capable person and establish credibility, they will be good sources of news as well.

You will find that your job is easier when Cmdr. Tilde, the medical officer, calls to tell you about a new medical device being tested at the clinic; or when PNC Umlaut informs you that the Navy's oldest enlisted man has reported aboard; or when Mr. Caret at MWR lets you know that a base civilian signed a minor league contract to play in the New York Mets organization; or when Lt. Breve announces to you that he is engaged to marry a former Miss America.

Eventually, all of these stories might have faltered down to the PAO, but the fact that you were informed firsthand gives you ahead start on getting the story out while it is still news.

## **FUTURE FILE**

Most public affairs offices should maintain a current listing of all events that have been scheduled or planned for the future. Material collected in the **future file** usually falls under the heading of **created news**. The public affairs office develops the ideas, plans and writes the stories and releases them to achieve maximum dissemination.

The public visitation of your command, for example, is scheduled months in advance. To make sure the visitation is a success, the PAO embarks on a planned publicity program. Prominent public figures are invited as guest speakers. Displays and exhibits are set up. Parades, reviews and drill team demonstrations are planned. An air show, ranging from a simple, low-level flyover to unique maneuvers of the famed Blue Angels, may be scheduled. A steady flow of releases about the program plans is sent to news media to attract attention and visitors. Another event similar to public visitation is a planned, detailed program about the construction of a new ship, especially anew type of ship. A public affairs program is generated for the keel laying, building, christening, launching, fitting out, commissioning, sea trials, assignment to fleet and force commanders, and finally, the shakedown cruise.



However, not all material developed by the PAO takes place on such a large scale. A visit by an important dignitary, a CO's speech, the return of a ship from extended operations, special anniversaries, observances of national holidays in conjunction with the civilian community and athletic and entertainment events that will benefit charities are all created news items included in the future file. The PAO gives these events advance buildups, spot news coverage, and occasionally, follow-up coverage.

The future file is usually a collection of file folders, each one containing advance information about a particular upcoming event. It can also be as simple as a calendar pad with enough space in its blocks to write key words that serve as reminders. A wall-sized grid under plexiglass works well too.

Another variation of the future file is the date-box. This consists of 31 file folders containing advance material for each day of the month.

Whatever arrangement is used, all public affairs offices should maintain a good tickler system of upcoming events to assure complete coverage of all news events.

## METHODS OF GATHERING NEWS

*LEARNING OBJECTIVE: Recognize the most commonly used methods of gathering Navy news.*

The four most commonly used methods in news gathering used by Navy journalists are observation, telephone conversations, research and interviews.

### OBSERVATION

Observation consists of your actually seeing an event take place and then reporting what you have seen in the form of a news story. The difference between a good story and a poor one is often in the skill of the observer. Skilled observers use their eyes, ears, mind, notebooks and tape recorders. They make sure they get the concrete facts, specific figures and accurate information. They look for the colorful, the dramatic or the unusual in any situation.

Skilled observers always try to get more information than they actually need. They know it is easier to discard excess material than to retrace their steps after the story is cold. Developing your powers of observation can come only through experience. You cannot become a skilled observer by simply reading a

book. The key to becoming a good observer is to look for more than you see on the surface.

## TELEPHONE CONVERSATIONS

The telephone plays an important role in your daily work as a journalist. It saves you time, legwork and it often enables you to reach people who are ordinarily too busy to see you in person.

Telephone conversations may range from full-scale interviews to brief queries to verify or amplify information. But regardless of how often you use this method of news gathering, you should keep the following points in mind:

- Know what information you want before you dial. Keep your pencil and paper handy. Do not call someone and then ask that person to wait while you look for writing materials.
- Speak politely indistinct, well-modulated tones.
- Be cheerful and businesslike.
- Make sure you get your facts straight. Ask the other person to repeat figures or spell out names.
- Avoid three-way conversations among yourself, the person on the telephone and somebody else in your office.
- Recheck your information by reading it back to the person who has given it to you.
- Record the conversation using a "telephone pick-up" (a device that attaches to the telephone receiver and plugs into the microphone jack of the cassette tap recorder). Be sure to inform the person on the other end that you are recording the conversation for note-taking purposes only.
- **Do not** discuss classified information.

Although a telephone is a very useful instrument, remember it is not the only, and not necessarily the best, method of gathering news. It should supplement, but not replace, all other methods. Whenever it is proper and convenient, use the telephone, but do not be afraid to engage in a little legwork

## RESEARCH

Research is nothing more than digging out information from files and reference works. Research is used to verify or amplify facts in news stories and to give depth to feature stories and magazine articles. Very few

Navy public affairs offices have adequate reference libraries. To do any extensive research, learn to use the facilities of the nearest Navy, public or college library. Here you can find the necessary books, encyclopedias, almanacs, magazines, atlases, directories, indexes and similar references. The Naval Historical Center (OP-09BH), Washington, D.C., is a good source of additional information about the Navy.

## INTERVIEWS

About 90 percent of everything in a news story is based on some form of interviewing — either in person, by telephone, or occasionally, by correspondence.

As a Navy journalist in search of information, you must learn who to get information from and how to record facts. You must learn techniques for handling different kinds of people — how to draw some out, how to keep others on the topic and how to evaluate the motives or honesty of others. In short, you must learn how to get along with people and how to treat them with tact and understanding while still accomplishing your purpose.

### Types of Interviews

A distinction must be made between news stories that are merely based on interviews and actual interview stories. Very seldom is a journalist present at the scene of an accident as it takes place — for example, at a collision between two automobiles. A story of this type must be based entirely on interviews — either in person or by telephone — with the police, with eyewitnesses, with the victims themselves, and depending upon the gravity of the accident, with the garage mechanics, hospital attendants, relatives of the victims and others.

In news stories of this kind, the journalist is concerned with a news event that requires interviewing people to learn the facts. The **interview story**, on the other hand, is essentially a feature built around the views, personality or exploits of an individual or group of individuals. The difference, in most cases, is largely in the emphasis. In writing the **interview-based news story**, you stress the news, whereas in the **interview story**, you place the stress on the person being interviewed.

Interviews are as varied as the people who grant them, the journalists who conduct them and the news that suggests them. Rarely are interviews so mechanical that they can be reduced to standard formulas or categories. Several types, however, deserve special

attention because they are the ones that occur most frequently. They are as follows:

- News interview
- Telephone interview
- Casual interview
- Personality interview
- Symposium interview
- News conference
- Prepared question interview

**NEWS INTERVIEW.**— The news interview is based on “hard news,” some event or development of current and immediate interest. Suppose you are a journalist assigned to the staff of Commander, Naval Air Force, U.S. Atlantic Fleet (COMNAVAIRLANT), and a new supercarrier has been launched for the Navy. Later, you learn the earner will be assigned to the Atlantic Fleet, and you are assigned to write the story. The original news announcement released by the shipyard or naval authorities would most likely contain only the broad, straight facts — cost, size and construction details.

A story of this scope is of major interest to the local community of the supercarrier’s home port. Media want more information than is offered in the initial report. By interviewing competent news sources, such as key officers on COMNAVAIRLANT’s staff, and asking well-defined, carefully considered questions, you can localize, illuminate, expand and add depth to the original story. When will the ship be commissioned? How will the ship’s presence affect the local economy? What will its mission be? When is it expected to join the fleet? To which carrier division will it be assigned? Will there be a flag officer embarked? Has a prospective CO been selected? How will this new carrier strengthen our national defense effort?

In any interview, try to speak to the best authority available. Do not settle for the supply clerk if the information you need should come from the CO.

**TELEPHONE INTERVIEW.**— The telephone interview, a modified version of the news interview, has a number of obvious advantages, and at the same time, it has several limitations that challenge a resourceful journalist. Ingenuity and clear thinking are sometimes needed to locate a news source when a big story breaks; the power of persuasion is often necessary to elicit information from a reluctant person who can easily hang up the receiver, and a sympathetic telephone voice is

important when you are talking to a family where tragedy has struck

**CASUAL INTERVIEW.**— An accidental encounter between a journalist and a news source on the street or at a social gathering can often result in a tip that arouses the curiosity of a writer. A major news story may be the result after you do some digging.

**PERSONALITY INTERVIEW.**— In the personality interview an effort is made to let the reader see the appearance, mannerisms, background and even the character of the subject. Magazines like the *New Yorker* have developed this type of interview, called “a profile,” into a high art not easily attained by daily newspapers under the pressure of deadlines. However, with preliminary research on an interviewee’s background, intelligent planning of questions and skillful interviewing, a good journalist can let a person’s words and mannerisms bring that individual vividly to life in an interesting newspaper feature story.

**SYMPOSIUM INTERVIEW.**— From time to time, news developments of current interest require a journalist or a team of journalists to seek information not from one or two sources but from a dozen, or perhaps a hundred or more. For example, which of the two presidential candidates in the television debate made the best impression on the public? How do the residents of a city feel about their football team winning the Super Bowl? For some stories — as in a pre-election poll — all of the techniques of a scientific opinion sampling may be required. In other instances, reactions and comments may result in a lively feature story. Depending on the subject, the symposium (or group) interview may bring out opinions of importance, entertainment or merely the views of the “man on the street” on some subject of general interest.

**NEWS CONFERENCE.**— In recent years, an increasingly popular phenomenon of journalism has developed — the news conference. By presenting news conferences “live” on television, President Kennedy raised them to one of the most potent forces in the public exchange of opinion between the people and their government. For close to 70 years, in a different format, the news conference has been an important source of news. The person interviewed at a news conference may be the President of the United States, the Chief of Naval Operations, a senior government official, the manager of a big league team, a movie star plugging a new motion picture or any other person promoting what is believed to be a news story of interest to the public. As in every interview story, preliminary groundwork pays off; a knowledge of the interviewee’s background is

indispensable. During the interview, an alertness to story possibilities often leads to unexpected results.

Additional details on news conferences are covered later in this chapter.

**PREPARED QUESTION INTERVIEW.**— When direct person-to-person questioning cannot be arranged with an important news source, journalists occasionally resort to giving that source a set of prepared questions to which a reply is requested. More often than not, however, the questions go unheeded. When the journalist does get a reply, a major news story generally results.

In every interview assignment, the journalist’s objective is always the same — to ferret out as much news, details, significance and color about a personality or event as possible. The success of the story depends on the quantity and quality of the information gleaned from the interview and the journalist’s sense of news values and writing ability.

### Interview Tips

The manner in which you prepare for conducting interviews can often determine the successor future of those projects. What follows are 10 tips on handling interview assignments that should prove useful to you.

1. Know what you want. Whether you are interviewing someone for a hard news story or you are on an assignment for a feature, remember you are the one who will have to write the story. This means that you must bear in mind the essence of the story you are after or the angle you want to develop. If you are covering a fire, what are the things you should find out? They will include whether anyone was hurt, the extent of the damage, the cause of the fire, how it was discovered, which fire stations responded, how long it took to put out the blaze and many other facts.

The same kind of analysis must be applied to all stories. This will guide you in your questioning, and most important, in your search for details. Learn how to dig for facts. Be alert, interested and curious. Details are more vivid than generalities. For example, if your subject casually mentions he was the editor of a college newspaper, find out the name of the college and when the position was held. These are simple, natural questions that will come to the minds of some of your readers; do not leave them unsatisfied. Every story is unique. It will differ from others in many details. Unless you know what to look for and how to get it through proper questioning, your story will be incomplete.

**2. Prepare for the interview.** Whenever possible, particularly on a feature assignment, lookup your subject's background. From news clippings or from reference works like *Who's Who*, try to determine beforehand any views the individual may have on the topic of your interview. Ignorance of an important person's biography and work may seem insulting to the individual concerned, and you may lose the person's cooperation. However, you should never try to impress the interviewee with your knowledge of the individual's own subject.

**3. Plan your questions.** This does not mean you should read them formally or present them in an artificial manner. Conduct your conversation in a natural, informal fashion. Always keep your questions in mind and try to guide the conversation along lines that will give you a story with substance. Planned questions, jotted down on a pad in front of you, are particularly valuable when you interview someone by using the telephone. At the same time, be receptive to a new angle that may arise and may be better than the one you had originally planned.

**4. Be careful about taking notes.** Some interviewers write everything; others write hardly a word. Some subjects become uncomfortable in the presence of a reporter transcribing every word they say and at the prospect of having their names appear in the paper. Other interviewees prefer to have their words written down to avoid being misquoted. In general, you will probably remember most of the conversation if you write the story while it is still fresh in your mind. Details, such as names, dates, statistics, key words and distinctive phrases, should, of course, be jotted down on the spot.

If you have access to a small, portable tape recorder, by all means use it. Some subjects may be uncomfortable in the presence of a tape recorder, but most will not. Try to use a tape recorder with a built-in microphone. This will avoid the sometimes awkward practice of holding a hand microphone to the interviewee's face.

**5. Know your subject.** Some people need to be flattered; others cajoled. Some are naturally shy; others will talk a blue streak. Evaluate your interviewee and guide yourself accordingly. The majority of people will react favorably to a straightforward, factual approach and will not be impressed by arrogance or excessive humility. Only courtesy, intelligent curiosity, a sincere desire to be natural and a knowledge of what you are after will help you come away from an interview with a newsworthy story.

These are major principles that can be applied in nearly all interviews. However, as previously mentioned, alert and resourceful journalists must be ready to vary their techniques depending on the temperament and views of the interviewee, the nature of the story and the dictates of circumstances.

**6. Be specific.** A question like "Anything new?" will, in most cases, bring forth very little information because the average layman knows little about what is of news value. Ask direct and leading questions.

**7. Be accurate.** The smallest error can cause embarrassment and even a libel suit. Do not be afraid to ask questions and to check facts. When you interview someone by using the telephone, one letter can easily be mistaken for another. Therefore, spell out names by using phonetic aids. Spell it: "S-M-I-T-H. S as in SIERRA, M as in MIKE. . . ." (Of course, make sure it is "Smith" and not "Smythe.") People dislike having their names misspelled. Also, obtain the complete and correct addresses of people in a story.

**8. Look for color.** In personality features, particularly, an apt word or phrase describing your subject's appearance or mannerisms will help your readers "see" the person. Here is a helpful suggestion: As you conduct the interview, try to think of words that would best describe your subject in a nutshell. In some stories, a reference to a person's movements, gestures, way of talking and his or her surroundings may give a better picture of that individual. Often, you will be able to make some comparison in terms of a figure or object familiar to your readers, but be careful not to offend the interviewee.

**9. Do not talk too much.** You are interviewing someone to get information, not to demonstrate how smart you are. At the start, you may need to lead the conversation along general lines to put the interviewee at ease and to get around to your subject. But after that, be self-effacing. On occasion, you may have to play dumb; then assume nothing and ask everything. Be conscious of time; do not waste yours or the interviewee's. Occasionally, a time limit is imposed on an interview. When time is limited, you will have to arrange your questions in order of importance. Although the relationship between you and your subject should be informal, remember that the nature of your call is business, not social.

**10. Remember your sense of humor.** This may break the initial ice or even save your interview if the interviewee has a negative attitude.

One final thought — the best kind of interview is one that proceeds in a friendly, natural, informal way. There was a time when some news people thought little of using deception or impersonation to get the information they wanted. Respectable newspapers and other media frown on these practices today.

Additional information on interviews maybe found in Chapter 15 (Radio and Television Interviewing).

### **AUTHORITY FOR RELEASING NAVY NEWS**

*LEARNING OBJECTIVE: Identify the proper authority for the release of Navy news.*

When information previously limited to a controlled number of persons is made available to the general public, it is said to be “released.” If this is done in formal written form, the document itself is termed a **release**, or a **news release**. Officers in command of all ships and stations, as well as senior commands, are authorized to release certain types of news without requesting advance approval from higher authority.

News of purely local interest is the first of this type. However, there are certain cautions. All officers in command are responsible for keeping CHINFO and other concerned seniors informed of all events and actions when any possibility exists that the national news media may become interested. There are also special procedures for handling news releases relating to members of Congress and civic officials.

Spot news, including announcements or answers to queries of an emergency nature, where delay in issuing information would be harmful to the best interests of the Navy, is releasable without advanced approval of higher authority.

Categories of news releases for which local release is not authorized, without prior approval of higher authority, are covered in detail in *PA Regs*. A partial list of these categories is included in figure 7-1.

In some cases the PAO is authorized by the officer in command to release certain news items, such as “hometowns” and news of a purely routine nature.

Release of information by any command is carried out by, or with, the assistance of the command PAO. Offices or divisions within a command cannot release information to the public without consulting the PAO.

For a complete study on the proper release of information through channels from the heads of

#### **A. Accidents and Casualties**

1. Civilians on board Navy ships, etc.
2. Foreign nationals in training with the Navy
3. Involving more than one service
4. Nuclear
5. Names and photographs of casualties

#### **B. Biological Research, Chemical Warfare and Psychological Warfare Programs**

#### **C. Classified Information and Intelligence Activities**

#### **D. Foreign National and Foreign Countries**

1. Policy
2. U.S. foreign defense plans
3. Operations and training exercises

#### **E. Movements of Units**

1. Between ports in the U.S.
2. Overseas areas

#### **F. New Weapons and Equipment**

1. Performance or capabilities
2. Modifications resulting in improvement

#### **G. Nuclear**

1. Nuclear propulsion
2. Nuclear weapons capability of U.S. forces
3. Port visits of nuclear-powered ships
4. SSB(N) operations

#### **H. Personnel**

1. Movements of
2. Name and address lists (example: “FOUO” directories)
3. Reduction in personnel
4. Statistics

#### **I. Scientific Results (unclassified)**

#### **J. Submarine Sightings**

#### **K. Supply**

1. Sources/quantities of strategic or critical supplies.
2. Movements, assembly and storage of supplies/ materials

#### **L. Technical Information**

#### **M. Training of Specialized Units**

Figure 7-1.—Subjects not releasable locally (unless approved by higher authority).

government down to individual units, refer to the most current version of *PA Regs*. It describes the procedures for releasing news at all levels of interest — local, regional, national and international.

## METHODS OF DISSEMINATING NAVY NEWS

*LEARNING OBJECTIVE: Determine the methods of disseminating Navy news.*

Navy news material, properly authorized for release, can be channeled to the media in several ways. The nine commonly used methods are as follows:

- Standard Navy news release
- News advisory
- Spot news announcements
- News conferences
- Interviews
- Background briefings
- Feature releases
- Advance releases
- Personal appearances

## STANDARD NAVY NEWS RELEASE

A Navy news release is an official Navy statement prepared in news story form. The enlisted journalist normally prepares and edits it, then the PAO, through the authority of the officer in command, approves the release. As a Navy journalist, you will work with the Navy news release more than with any other method of news dissemination. A well-prepared and edited standard Navy news release — placed in the hands of all interested media at the same time, supplying all with identical information — remains the most satisfactory method of releasing news.

Most public affairs offices, particularly at larger commands, use a printed heading for their news releases. These are attractive and help members of the media identify the source of the release more quickly. However, they are by no means necessary. If a printed heading is used, keep it simple, informal, suitable and in good taste to cover all types of releases. The news value of the material, and not the packaging, is the most important consideration. A sample release format is shown in figures 7-2 and 7-3.

Certain information, however, should always be included in the heading of a release. Make sure your release format includes the following items:

- Name, address and ZIP code of the originating command
- Office telephone numbers (including facsimile number)
- Point(s) of contact for further information
- Type of release
- Release number
- Short headline to identify the content of the release
- Date of release

News releases should be double-spaced, typed on only one side of a sheet of paper and legibly reproduced. Official directives regarding economy in duplication on both sides of the paper do not apply to news releases.

## Timing of Navy News Releases

The timing of news releases is almost as important as their content. An improperly timed handout maybe lost in the media editor's in-box simply because it is poorly timed.

Most Navy stories are distributed **For Immediate Release**. This authorizes the media to use the story as soon as it is received.

Occasionally, however, it is necessary to distribute a story on a **Hold For Release** basis. This tag, along with the authorized date of release, is attached to important feature stories. It is usually typed in the spot where **For Immediate Release** appears in the figure 7-2.

Assume that the CNO accepts a speaking engagement in your city. If an advance copy of the speech is available, it may be released to news media on a **Hold For Release** basis. This would give news media several advantages. First, reporters covering the event would not have to take notes of the speech. They would merely check their future release to make sure the CNO followed the text. Second, television or radio people may not want to record the entire speech. With an advance copy of it in their possession, they could tape only key portions. Third, if the speech is important enough, newspaper editors may decide to publish it verbatim. The advance copy would permit them to set the speech in type beforehand so the speech could be printed immediately after it was delivered.

**PUBLIC AFFAIRS OFFICE  
NAVAL STATION WEIERSTRASS  
MAKAPUU POINT, HAWAII 96885-7748**

**TELEPHONE: (808) 885-9847  
886-9848  
DSN: 334-9999  
FAX: 885-9849**

**FOR FURTHER INFORMATION, CONTACT**

**LT HACHEK PRAWN (PAO)  
JOCS JEAN IOTA (APAO)**

**OFFICIAL NEWS RELEASE**

**FOR IMMEDIATE RELEASE**

**RELEASE #12-94  
FEBRUARY 2,1994**

**SHORT HEADLINE HELPS EDITORS IDENTIFY STORY'S NEWS PEG**

WITH THE FIRST FLEET, February 2 — This is the recommended first-page format for Navy news releases. It is for immediate release under a dateline. The "heading" contains the office of origin and its mailing address, telephone numbers, fax number, point(s) of contact for further information, type of release, release number, headline and date.

Other recommended styles of datelines are as follows:

1. For releases originating ashore:

SAN DIEGO, Calif., Feb. 2

2. For releases originating at sea:

ABOARD THE USS CONTOUR INTEGRAL AT SEA, Feb. 2

If there is more than one page of copy in a Navy news release, end each page, except the last, with the word "more."

-more-

**Figure 7-2.—Sample Navy news release format (page 1 of 2).**

**NS WEIERSTRASS PAO  
NAVY NEWS RELEASE FORMAT  
2-2-2-2-2**

Second and subsequent pages of the release should be "slugged" for identity and numbered as shown above.

Do not hyphenate words between lines, and do not break sentences or paragraphs between pages. Paragraphs are indented five spaces. Begin your first paragraph about one-third to one-half of the way down the first page.

The copy itself should be neatly typewritten, double spaced in lines 60-75 characters in length with one-inch or better margins all around. This allows the editor to editor make notes on the release.

Use a high-speed copier when several copies of a release are necessary. Make sure each copy is legible. When a number of pages are involved, check to see that the pages are in order and that there are no blanks.

Remember, do not clutter an editor's desk with a news release unless you are telling him something newsworthy.

Finish your story on the last page with either "-30-" "-end-" or "-USN-" to indicate the end.

-USN-

**Figure 7-3.—Sample Navy news release format (page 2 of 2).**

In general, however, news media prefer to use news as soon as it is received. Reporters take pride in bringing facts to light, not in withholding them. Never give them a story marked **Hold For Release** unless you have a good reason.

### **News Release Numbering System**

For quick reference and orderly filing, a release number is assigned to all outgoing stories. There are various systems of assigning release numbers. Most commands follow the practice of beginning a new series at the beginning of each year. The first release sent out in 1994, for example, would have a release number of 1-94. The second release would be 2-94, and so forth. All releases are numbered consecutively in this manner until the end of the year. Remember that release numbers are assigned to each story, not to each copy of a story. If one release is sent to 17 different media, all 17 copies should bear the same release number.

### **NEWS ADVISORY**

A news advisory is an abbreviated form of a news release intended to get the news media to cover an event themselves. The news advisory is normally no more than a page in length and includes a compact description of the event. Pertinent information, such as the date, time, location, specific details and the significance of the event, also should be included. You may disseminate the news advisory in the same manner as a news release, using the format in figure 7-2.

### **SPOT NEWS ANNOUNCEMENTS**

When an event of immediate and urgent news interest occurs within the command, such as an unscheduled VIP visit or an accident involving casualties, all available and properly releasable facts are issued promptly and without waiting until a complete account is compiled. Spot news of this type is usually released by bulletin or in memorandum form. However, if circumstances require, it may be read over the telephone. Spot news is always issued **For Immediate Release**.

### **NEWS CONFERENCES**

Whenever a news event is of great importance to the local public or when there is a visit by a prominent official who wishes to address the media, a command calls a news conference and sends invitations to all interested media. Information is released at a news

conference through a senior naval officer or other Navy spokesperson, an individual involved in unclassified activity of public interest, an expert in some newsworthy project, survivors of an accident or perhaps someone directly involved in some activity or event.

Often, after an advance release goes out announcing the intended visit of a VIP or some other event of significance, the media requests a news conference.

When time permits, prepare media information kits (covered in Chapter 16) to supplement information made public at news conferences.

Avoid, if possible, requesting media to submit questions in advance. When advance questions are desirable, as in cases where highly technical answers would be required for some questions, correspondents should be advised of this. When written questions are volunteered, detailed answers are normally prepared and distributed to all attending media representatives immediately preceding the conference.

A news conference can be abused. The only reason to call a news conference is to release information that cannot be covered adequately by a news release. A news conference should not be used solely as a prestige vehicle. It should be called only when there is something to say. Most media cannot spare the time and personnel for this type of coverage. The quickest way to alienate reporters is to make them cover an event in person when they could have covered it over the telephone.

A news conference can do a lot for the Navy when it is used properly. News conferences establish public esteem, erase controversy and show that the Navy has nothing to hide. Reporters are given the opportunity to ask questions and get all the information they want. This often results in clearing up misunderstandings. Finally, it enables all media to get the same information at the same time.

### **INTERVIEW**

An interview differs from a news conference in that it is usually initiated by a media representative and involves communication of information from a responsible spokesperson to only one reporter.

### **BACKGROUND BRIEFINGS**

Background briefings differ from a routine news conference or interview only in their usual provisions that a precise source is not identified in the reporters' stories. The content or source of a story written from a briefing is usually attributed to a "Navy spokesperson,"



“informed military sources” or some other truthful, but not specifically identified, individual imparting the information. In such cases, the ground rules are clearly understood and agreed to by all participants. In most cases, especially when the subject is not of a technical nature, these briefings are conducted by the command PAO.

## **FEATURE RELEASES**

Features, or “time releases,” differ from spot news mainly in the degree of immediacy. That is, it makes little difference whether particular news accounts are passed along to the general public today, tomorrow or next week.

A feature may concern previously undisclosed developments dating well into the past or some upcoming event or anniversary. Either way, it must contain a high degree of general human interest. This type of release is usually made in writing, but it may be given out through an interview or news conference. Often a feature release lends itself to pictorial treatment by the use of still photographs or videotape. Feature releases are issued for both immediate and future use.

## **ADVANCE RELEASES**

You read about advance releases (stories) in Chapter 5. Advance releases are issued concerning events scheduled or anticipated for the future. They are generally on a **Hold For Release** basis, specifying exact times, to make sure of simultaneous use by all interested media and to prevent premature disclosure. An advance release often is accompanied by an invitation to media representatives to attend an event and is usually supplemented by follow-up releases. Official photographs, printed programs or other material providing in-depth background on a forthcoming event are often enclosed with an advance release.

## **PERSONAL APPEARANCES**

Personal appearances include formal speeches and informal remarks by Navy officials and authorized spokespersons in which information is released to appear as an official news announcement. The information could be given at public or semipublic meetings, in public forums, on radio and television programs or during any other contact with the public. The size of the group being addressed is irrelevant, and it does not matter whether the remarks are or are not reported by the news media.



## CHAPTER 8

# PRINTING, LAYOUT AND MAKEUP

Despite the popularity of radio and television, the Navy and the public-at-large are very much print-oriented. All large ships and stations and many of the smaller Navy commands publish newspapers or magazines regularly. Consequently, as a Navy journalist, you can expect to be tasked with editing or assisting in the production of such a publication.

Should you somehow miss out on this challenging opportunity, a number of other items requiring an editor's skills and knowledge will likely surface on your desk some morning. Among these highly probable assignments are familygrams, change of command programs, public visitation brochures and cruisebooks.

Therefore, the information in this chapter, while directed primarily to potential newspaper editors, also is intended to acquaint you with the fundamentals and terminology of printing and the mechanics of laying out and making up copy for the publisher. Tips on designing Navy newspapers for a contemporary audience are included in this section, as well.

### OFFSET LITHOGRAPHY

*LEARNING OBJECTIVE:* Recognize the principle of offset lithography, its paste-up process, and the types of artwork used in photo-offset printing.

Offset lithography is the most preferred method of printing in both the civilian and military communities. Today, more than 90 percent of the nation's newspapers and closer to 95 percent of the larger service publications are products of offset presses.

Based on the principle that oil and water do not mix, offset lithography uses a flat-surface plate in its printing process. In offset printing, the plates are prepared through a technical photochemical process that leaves the nonprinting areas of the plate receptive to water.

On an offset press, two sets of rollers pass over the plate cylinder. One spreads water over the plate. Only those parts representing white space remain damp. The second roller spreads ink that only sticks to the parts of the plate that are dry. The plate then passes against a rubber-covered "blanket" cylinder that accepts the

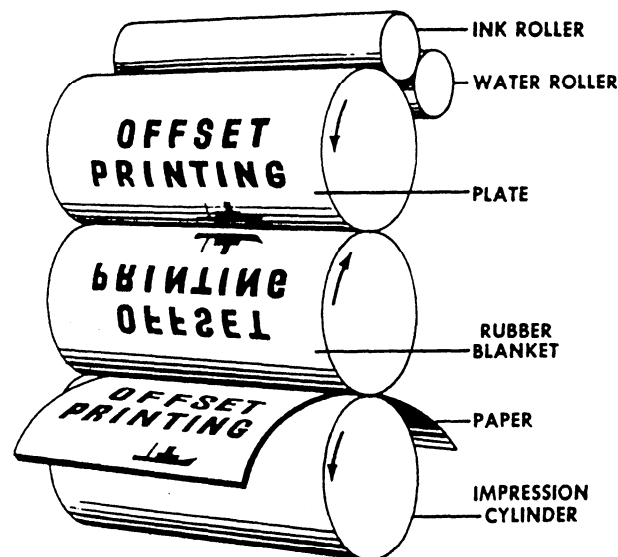

Figure 8-1.—The process of offset lithography.

inked image. The blanket cylinder "offsets," or transposes, the image to the paper which is carried through the press and pressed against the blanket by an impression cylinder. This process is shown in figure 8-1.

### PHOTO-OFFSET COPY

Let's now evaluate what must be done to prepare copy for photo-offset equipment.

The set copy is mounted, along with line art, on a paste-up (layout sheet) for photographing. The way art and type are mounted on the paste-up has a great effect on the quality of the finished product. Take care to avoid shadows and wrinkles. If possible, make the paste-up to the actual size of the newspaper.

In some cases, a Navy editor may only indicate the sizes and positions of the various elements on the layout sheet and then let the publisher position them accordingly. However, you can save much time and effort when you make the complete paste-up yourself. It is easier for you to cut and paste the paper than it is for the publisher to work with the photographic negatives and positives for final assembly.

You will need the following items for the paste-up operation:

- A drafting board or table
- A prepared paste-up (layout) sheet
- A “T” square
- A steel straightedge
- Rulers
- Rubber cement
- Erasers
- An india ink set
- A cutting edge (X-acto knife or single-edge razor blade)
- Light blue (nonphoto blue) lead pencils
- Scissors
- A scale system to determine photo-reproduction size
- A printer’s rule

solid-color art to be included on the paste-up should be enlarged or reduced to the exact size allotted for it on the layout sheet. Type proofs must be carefully checked to see that the lines of type are straight and the proofs are pasted down square with the page. These proofs, as well as art, must be handled with great care. The camera records every error and every smudge of a careless paste-up. For you to corrector eradicate such errors is always costly and often impossible after the plates are made.

Ordinarily, light-blue lines are used on the paste-ups to indicate margins. Light blue will not show up in the final photography. If necessary, you can draw in blue lines yourself, but in a week-to-week operation, it is much better to have them printed on standard layout sheets. Check with your publisher for advice before having your layout sheets printed on the various types of margins that should be marked — and on the amount of extra white space to leave for the publisher to work with. Any lines you want to appear on the finished page must be drawn or pasted in, in black, on the paste-up sheet. Only lines in black india ink will reproduce clearly on the offset plates.

## PHOTO-OFFSET ARTWORK

Artwork used in photo-offset printing includes line art and halftone art. These are covered in the information that follows.

### Line Art

Line art (illustrations, rules, headlines, borders, cartoons, crossword puzzles) and any other piece of

There is also a number of alphabets printed on sheets of transparent acetate or cellophane you may use for headlines. These sheets have adhesive on one side for pastedown purposes. When using them, you simply cut out the letters with a knife and apply them to the paste-up. Paste-up and pressure transfer alphabets are known by their trade names, such as Formatt and Artype. Figure 8-2 shows how paste-up lettering is prepared. Another preferred method is to draw guidelines on the

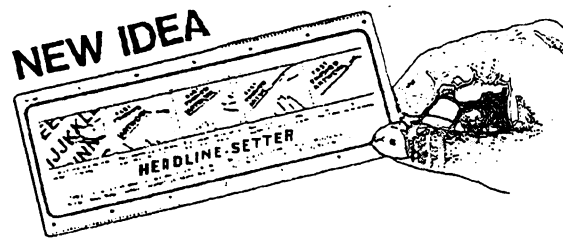

CUT AROUND LETTER, INCLUDING UNDERLINE AND LIFT OFF BACKING.

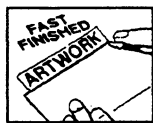

PLACE UNDERLINE ON GUIDELINE ALONG EDGE OF HEADLINE SETTER.

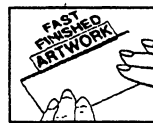

MOVE COMPLETE HEADLINE INTO DESIRED LOCATION ON ARTWORK.



BURNISH SCRATCH-PROOF HEADLINE INTO PLACE ON ARTWORK.

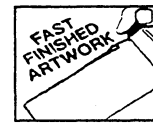

CUT AWAY HEADLINE SETTER. (PEEL OFF UNDERLINES BEFORE REUSING.)

Figure 8-2.—Paste-up lettering.

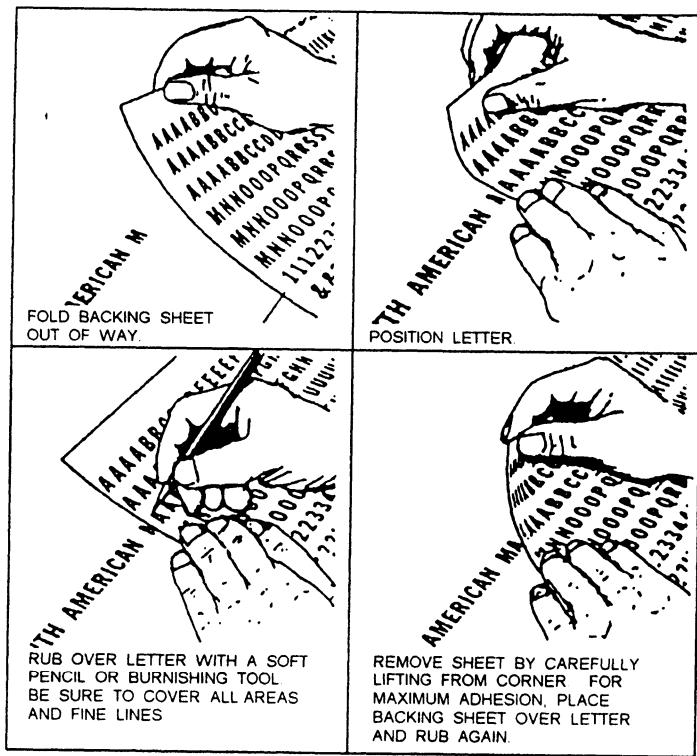

Figure 8-3.—Pressure-transfer lettering.

paste-up in light-blue pencil then to position each letter in its proper place.

Pressure-transfer lettering (fig. 8-3) is similar to paste-up lettering, since the letters of the alphabet are printed on acetate sheets. However, instead of cutting the letter out of the acetate sheet and attaching it to the paste-up, you simply move the sheet until the desired letter is in the proper position; then you rub the front of the sheet with a pencil or burnisher. When pressure is applied, the letter transfers from the back of the acetate sheet directly to the paste-up. You can remove a pressure-transfer letter with an ordinary pencil eraser, X-acto knife or masking tape.

One disadvantage of using printed lettering sheets is that when you run out of frequently used letters, you have to acquire a new sheet.

In addition, there are several “headliner” machines on the market that produce display matter photographically. The heads are set in long lines or strips that are then trimmed and pasted in place on the layout. Headline preparation is covered in Chapter 9.

### Halftones

Photographs cannot be pasted onto the layout with type and line art because they must be photographed

through a halftone screen. Therefore, they are often shot as separate negatives and then spliced into the master (line) negative of the page before the plate is made. With this method, only the shape and size of the halftone are indicated on the page layout. This is accomplished in several ways. The simplest is to “mask out” the area where the halftone will be positioned with india ink or black paper. Another way is for you to square off the space on the paste-up, putdown a piece of red adhesive film and cut it to fit the halftone area. The camera photographs the red the same as black. The red cellophane is more expensive, but it is much easier to use and often more accurate. Red or black space on the paste-up appears as clear space on the negative. It serves as a window through which the platemaker can accurately position the halftone negative into the line negative.

Another method is to print the photograph to size, screen it and paste it in place on the layout sheet before making the page negative.

Either method may be used at the publisher’s discretion. However, your concern will be with submitting the artwork to the publisher in the proper form with the appropriate guidelines explaining your requirements, rather than the mechanics of printing.

There are three ways to submit your photographs to the publisher. They are as follows:

1. When photographs are printed or cropped to the exact size they are to appear in the publication (a “one-to-one shot” in printing terminology), they may be mounted in their predetermined position on a separate layout sheet. Therefore, you will submit two paste-ups—one containing the line work and the other the halftones.

2. When photographs are to be reduced or enlarged, crop or scale them to indicate the desired size. Cropping and scaling will be covered later in this chapter.

3. When a halftone is to be of an irregular shape, the preparation procedure is somewhat different. In this case, a “window” for the platemaker is needed. You can make the window as follows: paste the actual photograph in position on the line paste-up, attach a clear acetate sheet over it, then, with red or black opaque paint, carefully paint in the area indicated by the outline of the photograph under the acetate. There is also a special material—a red-coated acetate—that can be used to outline the illustration. This red is translucent and can be scraped away from the outside outline of the halftone, leaving the red shape for the camera to record

as the window. If the job is very complicated, it is better for you to let the publisher do that kind of preparation. A good publisher will advise you on the best method of preparing photographs for photo-offset printing,

Be sure to protect your paste-ups carefully. If they are damaged—or if they get dirty — you may have to start over. It is a good idea to cover them with a tissue overlay and to protect them between layers of cardboard when taking them from one place to another.

## DESKTOP PUBLISHING

*LEARNING OBJECTIVE: Define desktop publishing and explain its limitations and capabilities.*

In less than 10 years, desktop publishing has surfaced as one of the predominant personal computing applications. It has changed the way you, as a Navy journalist, produce a wide array of publications, from ship and station newspapers and familygrams, to welcome aboard pamphlets and commissioning/decommissioning brochures.

### DEFINITION

Simply stated, desktop publishing is an application that combines an economical personal computer system with page layout software and a laser printer to produce typeset-quality-printed products. This eliminates the need to work with dummy layouts and galley proofs, because the entire product is composed on a computer screen.

Using computers to compose pages is not a new concept. For many years, newspaper and magazine publishers have used computers for all facets of page layout and editing. However, the cost of their computer systems and accompanying software was prohibitive, and therefore, limited to national publications or those in relatively large markets. Accordingly, the manufacturers of customized computer publishing systems were hesitant to produce cheaper versions of their products. This changed in 1985 when desktop publishing went mainstream.

### TRADITIONAL VS. DESKTOP PUBLISHING

Desktop publishing allows you to throwaway your drafting board, paste-up sheet, “T” square, rubber cement and the rest of the printing and layout “tools of the trade” mentioned earlier.

Consider, for example, you are a J03 tasked with laying out and designing page 5 of your weekly funded newspaper. Normally you would work with the newspaper dummy where you indicate the arrangement of the copy, headlines, photographs and cutlines. Your main tools are a pencil, printer’s rule and eraser.

If you worked the same page on a typical desktop publishing system (fig. 8-4), you will notice a tremendous difference. You may lay out and design the entire page on the computer screen using the computer keyboard and a mouse. You could indicate the size and kind of type and its page position with relative ease. Using a seamer, you could insert illustrations and photographs into the layout; then make modifications as necessary. All the while you are working on-screen with body copy that will result in typeset-quality text — without the involvement of a military or civilian publisher.

### STRENGTHS

With the proper computer hardware and software in place, you will enjoy the following attributes of desktop publishing:

- A cut in printing costs by as much as 75 percent.
- Fast turnaround time.
- Making corrections to spelling errors, omission of words or entire lines of text and poor word division **at your office.**
- Making last-minute changes without a major reworking of the paste-up.
- Using less office space, a key consideration especially aboard ship.
- Eliminating the need to work with a publisher on the initial paste-up of a product, as discussed earlier.
- Eliminating the need to work with the sub-contractors of the publisher, such as typesetters, proofreaders, and so forth.

### WEAKNESSES

Any computer-literate JO can operate a desktop publishing system with relative ease. However, there are two common hazards you should recognize and avoid.

The old saying, “Familiarity breeds contempt;” certainly applies to desktop publishing. Some novice desktop publishers, convinced that the computer

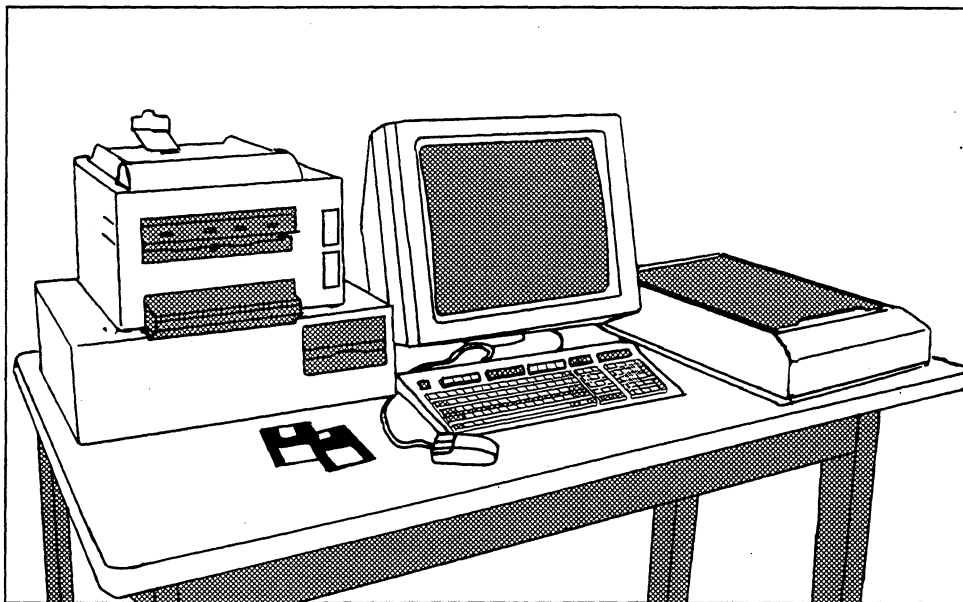

Figure 8-4.—The components of a typical desktop publishing system: personal computer, laser printer, scanner, mouse and software.

hardware and software are suitable replacements for talent and skill, become complacent in the basic principles of layout and makeup. In turn, they produce page layouts you would only see in your worst nightmares. Make sure you follow the long-established rules of layout and makeup covered later in this chapter.

In addition, you should apply some forethought when selecting your computer hardware and software. On occasion, some hardware components will not function properly with others, and there are some word processing programs that will not work well with certain desktop publishing programs. If you are purchasing a new system, make sure you get satisfactory answers to questions about compatibility.

### DESKTOP PUBLISHING SOFTWARE

*LEARNING OBJECTIVE: Identify the most common desktop publishing software and determine their basic features.*

There are several desktop publishing software programs for both Macintosh and PC-based computer systems. You should be aware that although these programs are similar in terms of overall operation, they vary widely in their capabilities and functions.

For instance, less elaborate desktop publishing programs are mainly suited for simple pamphlets and

brochures, while more complex versions include advanced features, such as indexing, style sheets and typographic operations you can use to control the spacing of single characters.

**NOTE:** Reference to the following desktop publishing programs does not constitute endorsement by NETPMSA or the U.S. Navy.

Some of the more common desktop publishing software packages available include the following:

- Aldus PageMaker
- Finesse (PC compatibles only)
- Interleaf Publisher
- Legacy (PC compatibles only)
- QuarkXPress (Macintosh only)
- Ready, Set, Go (Macintosh only)
- Ventura Publisher

Since new desktop publishing software programs (and newer versions of existing programs) are introduced to the marketplace frequently, you should research the features of as many programs as possible. As stated previously, make sure the program is compatible with your hardware. It should be able to convert files from your current word processing

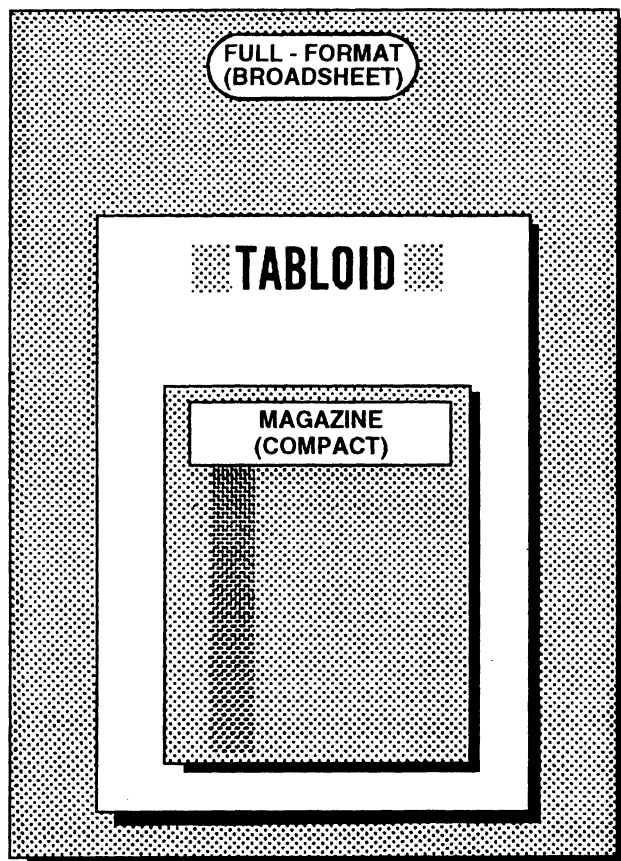

Figure 8-5.—Formats of ship and station newspapers.

program and have a good graphics file and a large selection of type fonts from which to choose.

### NEWSPAPER FORMATS

*LEARNING OBJECTIVE: Recognize the types of formats of ship or station newspapers.*

The three formats used in ship and station newspapers are full format, tabloid and magazine. These formats are shown in figure 8-5 and are described in the following text.

#### FULL FORMAT

A full-format (also known as broadsheet) newspaper is one that measures 16 or 17 inches wide and 21 to 22 inches deep. A full-format newspaper can be made to have five columns, six columns, seven and one-half columns, eight columns or nine columns.

#### TABLOID

A tabloid newspaper is about half the size of a full-format newspaper. It measures 10 to 12 inches wide

and 14 to 18 inches deep. A tabloid format newspaper can have two, three, four, five, five and one-half and six columns.

#### MAGAZINE

A magazine-format (also known as compact) newspaper is about half the size of a tabloid newspaper. It measures 7 to 8 inches wide and 10 to 11 inches deep. It can be made to have one column, two columns and three columns.

### NEWSPAPER DESIGN

*LEARNING OBJECTIVE: Detail the techniques used in ship or station newspaper design and any specific considerations, respectively.*

Other important considerations (beyond the news gathering, news writing and copy editing aspects covered in the preceding chapters) are the techniques for putting the material together so that your paper emphasizes what is important. You will also need to know what makes an attractive appearance and draws and holds the reader's eye. All of this is done through good layout and makeup designed to achieve the best overall appearance and style of the publication and to allow the reader to obtain the maximum information in the shortest time.

**Layout** is the planning of the position and page that each piece of copy or art will occupy in your publication. This includes your choosing the styles and sizes of headlines desired, the kinds and sizes of type to be used and deciding how to use them, and indicating these plans on the layout sheets.

**Makeup** is normally the execution of that layout by the publisher (the compositor), although sometimes the terms *layout* and *makeup* are used interchangeably. For instance, the name "makeup editor" is used on some newspapers instead of "layout editor."

#### THE DUMMY

Indicating on the layout sheet where each element will be placed (sometimes called dummied or roughing in) may be done as each segment of material is forwarded to the publisher. Some publishers will even give you rough proofs of galley type, headlines and art and let you make a paste-up dummy on a layout sheet. Paste-up dummies ensure a high degree of accuracy in page makeup because they give the publisher a better



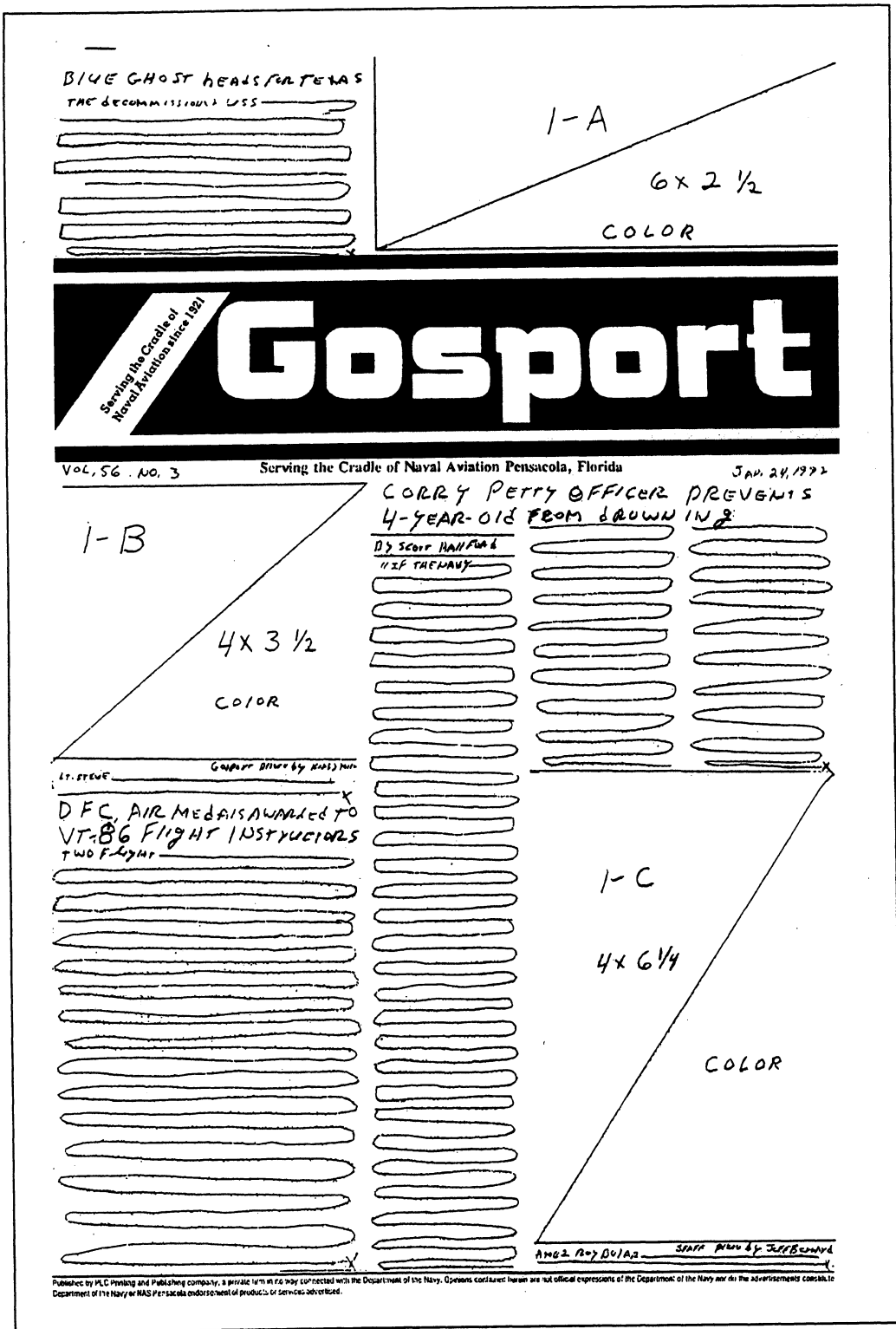

Figure 8-6.—Newspaper blueprint (dummy).

overall picture of what you want. Do not confuse a paste-up dummy with a paste-up for photo-offset work. A paste-up dummy is merely a guide for the publisher; a paste-up for photo-offset is smooth copy to be photographed for printing.

### THE BLUEPRINT

The blueprint for a newspaper is its layout sheets, or dummies, on which a detailed plan or sketch shows the arrangement of art, heads and copy to guide the compositor in making up the actual pages. Figure 8-6 is

## Blue Ghost heads for Texas

The decommissioned USS Lexington will depart the Pensacola Naval Air Station this morning for its final resting place at NAS Corpus Christi.

The decision was made by the secretary of the Navy late yesterday afternoon. His recommendation was then forwarded to Capitol Hill for release by representatives of the states which had been competing for the 48-year-old former warship.

The Lady Lex is being towed to its final destination by the fleet tug USS Edenton (AT-91).



# Gosport

Vol. 56, No. 3

Serving the Cradle of Naval Aviation Pensacola, Florida

January 24, 1992

## Corry petty officer prevents 4-year-old from drowning

By Scott D. Hallford

"If the Navy hadn't taught me CPR I probably wouldn't have been able to save her."

Those are the words of AME2 Roy Bolar after he pulled a 4-year-old girl from the bottom of his pool Christmas Day, initiating cardiopulmonary resuscitation and saving her life.

The girl, Rubye Stanfield, is a neighbor of Bolar who was apparently riding around his pool on a bicycle—a Christmas present—when she fell in.

"My brother-in-law noticed the bike was in the pool. Then Rubye's 6-year-old sister, Tiffany, noticed her lying in the bottom of the pool," said Bolar.

"I ran out and pulled her from the pool. She didn't have any vital signs, so I immediately started CPR," related Bolar. "Uncle Sam gave me my first aid knowledge. I'm really grateful for that, but the good Lord upstairs had something to do with saving Rubye, too."

Bolar's wife summoned paramedics while he conducted CPR. Rubye's mother, Jeannie, remembered rushing to the Bolars'. "I saw Roy giving Rubye CPR, yelling at her, 'Breathe, Rubye, breathe,'" she said.

Confused, the mother said she got mad at Bolar for yelling at, and "beating" on her daughter. "Then I realized he was saving her life."

Paramedics arrived, relieving Bolar and LifeFlight was dispatched to take the child to Sacred Heart Hospital.

Rubye stayed in the hospital five days. Doctors consid-

ered her recovery miraculous, her mother dubbing her "the Christmas Day miracle baby."

No one is quite sure how long Rubye was in the pool, but it was Bolar's basic lifesaving skills that initiated her recovery.

Bolar is quick to modestly point out, however, that it wasn't just him who saved Rubye. "It was all of us; paramedics, LifeFlight and the

doctors. If it wasn't for all of us, she probably wouldn't be with us."

The 30-year-old Manchester, Ohio, native is being considered for a lifesaving award. But, Bolar said "One of the best awards is Rubye. Although she is only 4 years old, she realizes she was very 'sick' and that I helped her."

Assigned to Corry Station, Bolar has been in the Navy more than 12 years.



Gosport photo by Lt. Kirby Miller

Lt. Steve J. Froncillo (left) and Lt. Charles L. Giacomo were recently cited for airman ship, heroism during Operation Desert Storm.

### DFC, air medals awarded to VT-86 flight instructors

Two flight instructors assigned to VT-86 were cited for heroism last week during a special ceremony.

Lt. Charles L. Giacomo of VT-86 was awarded the Distinguished Flying Cross and the Air Medal for heroism during combat operations in Operation Desert Storm.

The Air Medal was also awarded to Lt. James F. Froncillo for aerial strikes against Iraqi forces during Operation Desert Storm.

During the war, Lt. Giacomo was assigned to VA-75 deployed aboard the USS John F. Kennedy (CV-67). During the evening hours of Jan. 18, 1991, Giacomo and his pilot were assigned to strike a key uranium production facility near Al Qaim, Iraq. The lieutenant planned what was later described as a flawlessly executed first operational strike.

In pressing the attack, Giacomo's A-6E Intruder encountered heavy anti-aircraft and surface-to-air missile fire from enemy forces. But as a result of his precise navigation, the pilot was able to fly the Intruder to an exact launch point for his SLAM (stand-off land attack missile). The missile subsequently flew its programmed profile with pinpoint accuracy resulting in significant damage to the assigned target.

Five days later (Jan. 25), the Harrison, N.Y., resident was flying as a member of a night, multi-target air wing strike against a heavily defended superphosphate facility in central Iraq. For his heroic action during this flight, he was awarded the Air Medal.

Lt. Froncillo, a resident of Bristol, R.I., earned his Air Medal for heroic performance while assigned to VF-74 deployed aboard the USS Saratoga (CV-60). On Jan. 22, 1991, he participated in an attack against a SCUD missile storage facility at Qasir Amij, Iraq. As the lead aircraft for a division of four F-14 Tomcats, he and his fellow airmen successfully escorted eight F/A-18 Hornets through areas of intensive surface-to-air and air-to-air defenses.

The mission contributed directly to reducing the number of SCUD missiles attacks against population centers in Saudi Arabia and Israel.

Published by Pensacola Engraving Company, a private firm in no way connected with the Department of the Navy. Opinions contained herein are not official expressions of the Department of the Navy nor do the advertisements constitute Department of the Navy or NAS Pensacola endorsement of products or services advertised.

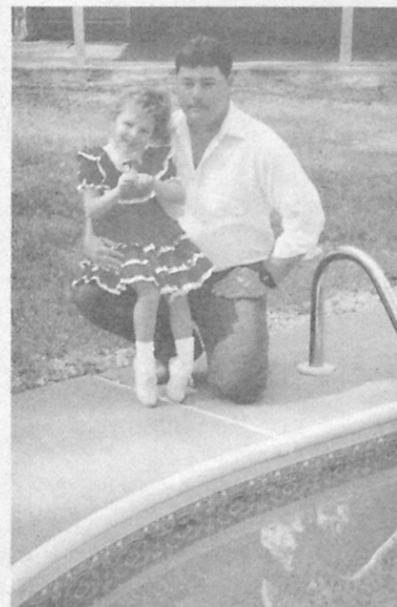

Staff photo by Jeff Bernard

AME2 Roy Bolar and Rubye Stanfield near the pool in which she nearly drowned on Christmas Day.

Figure 8-7.—The finished product based on the blueprint layout in figure 8-6.

an example of such a dummy, and figure 8-7 shows the finished product that resulted from it.

The layout is an absolute necessity if you are to avoid the amateur editor's nightmare —finding out the

day before publication that you have only eight pages of material for a 12-page publication. What is more, if you piece together a publication at the last minute without a layout — throwing in an article here and a picture there — you will come up with a meaningless hodge-podge.

Whether you consider layout an art or simply a mechanical skill, it is clearly an involved, demanding function. You must acquire the following skills to become a good layout editor:

- A keen news sense to know which stories to emphasize and how strongly to emphasize them
- A good working knowledge of typography
- An understanding of graphic design principles and techniques
- A familiarity with modern newspaper design techniques

Layout duties on ship and station newspapers are usually handled by the editor, associate editor and subordinate editors (sports, leisure, and so forth). On large commercial dailies, front-page layout is usually done by one of the executive editors — managing editor, news editor or copy editor — to ensure top-level emphasis of particular stories and ideas. Other pages are done by department editors (sport, feature, editorial) and by copy editors.

Remember: your layout is your blueprint, and blueprints are drawn to scale. So start by making up a standard layout sheet, showing the page with its columns drawn either to scale or to size. (A layout sheet of actual page size is the easiest to use.) The layout sheet should be marked for column widths. The top of each page should allow space for showing the issue, the page and the section of the paper. The best way to indicate where a story goes is to write in the story slug (the short identification line that goes right before the writer's name on a piece of copy), as shown in figure 8-8. You can use keys for art and your headlines can be written in.

## COPY FITTING

As a layout editor, you must be able to determine an approximate length, in column inches, of a story from typed copy. (A column inch is one inch of copy, measured down the column, regardless of the column width being used.) By making a few simple calculations, you can determine beforehand how much space the typed copy will fill when it is set in type (on the basis of 2 3/8-inch or 14-pica-wide column — six picas equal one inch). For most 10-point type, three typewritten lines, 60 characters wide (on a regular 8 1/2-by 11-inch sheet of paper) equal one column inch of copy. If other than 10-point body type is used, check with your publisher. Your publisher will provide for you a simple fitting formula for all sizes and styles of typefaces available, taking into consideration such things as variations in column widths, differences in fonts, and so forth.

Before forwarding your copy to the publisher, mark it clearly with all necessary instructions (guidelines) for the typesetter. If the publisher is going to make up the entire page from your layout plan, a piece of copy must contain the following notations:

- A key to its position in the layout (shown by the slug on the story and the slug on the dummy).
- The type and size of headline according to a headline chart (see Chapter 9).
- The specifics on the size and style of typeface (if it varies from the standard body type previously agreed upon between you and the publisher).
- The column width (one column, two columns, and so forth, should be designated by picas to avoid confusion with column inch measurements).

Once your layout is completed, you should be able to relax. A good publisher can make up your pages exactly as you want them from your blueprint, as long as you have provided the necessary information.

This section has covered layout techniques for offset printing, but most of the basic ideas covered here also can be applied to desktop publishing.

## CROPPING

Cropping is used when you only want to reproduce a portion of a picture. Pictures are cropped for the size, emphasis and composition desired. They are also cropped to focus on one specific area to achieve a desired effect in makeup. A picture can be cropped to show the hugeness or smallness of the topic. It can also be cropped to delete a dead area.

## Cropping Concerns

As a public affairs practitioner, your first responsibility is to make sure security, accuracy, propriety and policy are not violated when photographs are cropped. These areas are explained in the following text.

**SECURITY.**— During exercises, operational plans, maps, charts and equipment can be compromised easily by a photographer. Access is usually limited and photographers are kept away from secure areas, but breaches of security may occur in the heat of battle.

As you have heard before, “Operational security is everyone's business.” When cropping a photograph for reproduction in your newspaper, you should be aware especially of the background areas that might reveal classified information. Remember — exercises test war plans, and those plans cannot be compromised.

THE AMPHIBIAN  
Amphibious Force Pacific Fleet

P<sub>2</sub> #1

Record EM Advancements  
Predicted for Test Takers

A - lead, 2 col.

Exams 1/1/1  
JOSN Jackson

10 pt. 2 cl. lead

Navy Enlisteds who have just completed taking the March advancement exams should be happy about a recently-completed planning report which forecasts a "projected" total of more than 122,000 vacancies in pay grades E-4 through E-7 during 6 months covered by the promotion cycle.

The figures indicate promotion spots will be available for more than 5,800 new chiefs, more than 15,000 new first class petty officers, nearly 42,000 second class POs and more than 58,000 third class petty officers.

ht

Last August, 103,000 promotions were forecast, and more than 105,000 had earned their new stripes by december. The totals could go higher than the predicted 122,000 when the final returns are in, sometime this summer.

If qualified test-passers can be found to fit the predicted vacancies, the March tests seem likely to produce the largest crop of advancements since the Navy went to the bi-annual promotion cycle.

-more-

Figure 8-8.—Copy as marked for the publisher.

**ACCURACY.**— Make sure the photograph reflects reality. A photograph taken from the wrong angle or at the wrong time can, in fact, misrepresent the facts of the story. A road race taken at the finish line can show the

second place finisher ahead of the winner, if taken from the wrong angle. A sneeze or facial twitch during a somber ceremony can make the subject look like a fool in addition to misrepresenting the story.



**Figure 8-9.—Cropping marks on a photograph.**

**PROPRIETY.**— Beauty pageant swimsuit competitions, a sailor in an embarrassing pose and ethnic misrepresentations are but a few of the many propriety violations you might face when cropping a photograph. Although a photo editor should catch such violations during the process of photograph selection, you also must check for violations in the cropping phase.

**POLICY.**— Policy considerations are described, but are not limited to, the provisions of *PA Regs*. The DoD and DON have release authority over certain types of information. Information on weapons systems, controversial national and international subjects and certain Navy contracts will have to be approved for release.

In overseas locations, local policies come into play. Photographs of antigovernment protests in your host country, for example, normally are not taken in the first place. If you allow the photograph to be published in your newspaper, no matter how good your cropping job, you may enrage officials of the host country and your superiors. Policy considerations also include uniform violations, unsafe acts and promotional activities favoring one organization over another.

### **Distractions**

Distractions come in the form of anything that takes the eye away from the center of interest and action taking place. It could be a spectator in the stands at a baseball game or a student looking away from the

teacher in a class. It could be anything that detracts from the purpose of the photograph. You must eliminate portions of a photograph that do not contribute to good composition.

When cropping photographs, narrow the cropped area to the center of interest as much as possible. The rule of thumb is to crop ruthlessly and enlarge generously.

Try to limit the number of people in the photograph to three, or only those necessary to tell the story. When cropping people, do not crop them at the neck waist, knees or other joints.

### **Dead Space**

To avoid unnecessary dead space in the photograph, you should keep the center of interest contained. However, in cropping out dead space, leave enough space to accommodate the action of the center of interest. For example, if a car is traveling to the left of the photograph, leave room on the left for the vehicle to travel. Do not cut it off at the front bumper. The car needs dead space in which to travel.

If the subject or center of interest in a photograph is looking to the right, you must allow enough dead space for him to look into. Be careful not to allow too much dead space in a photograph. Too much background may make the center of interest get lost or not stand out.

The cropping marks are made at or near the corners of the photograph, as shown in figure 8-9. A china

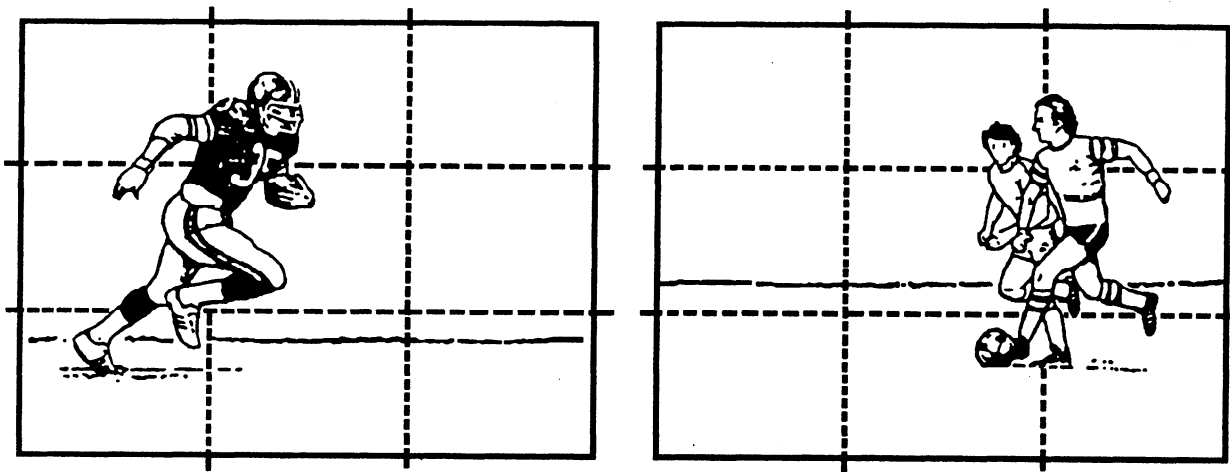

Figure 8-10.—The rule of thirds.

marker normally works best when making your cropping marks in the borders of photographs. China markers allow you to make changes without difficulty and mess.

### Aesthetics

The aesthetics, or beauty, of the photograph should be improved by cropping. The rule of thirds (fig. 8-10) suggests that the center of interest be positioned roughly at one of the four intersections created by equally spaced horizontal and vertical lines. These lines divide the photograph into horizontal and vertical thirds. When the subject is centered in the photograph, as is frequently done by amateur photographers, the photograph is often static and boring.

When you consider aesthetics, cropping should be based on the movement of the subject, leading lines, lines of force and other framing considerations that are explained in more detail in Chapter 12.

### Shapes

The shape of the photograph also must be considered before it is cropped. Normally, a 3:5 proportion is most pleasing to the eye. Proportions of 2:3, 3:4, 4:5, 4:7, and soon, are acceptable proportions. Simply cropping a photograph to make it square (3:3, for example) leaves a newspaper page dotted with square blocks and results in an unattractive page.

When you are considering the shape of a photograph, there are times when a strong vertical or horizontal will improve the look of a newspaper. Obvious examples where extreme horizontals and

verticals work well include tall buildings, parades, travel photo features and many sporting events.

### Photo Within a Photo

Careful examination of a print may allow you to extract two or more reproduction-quality photographs from a single print. There may be two centers of interest or separate actions taking place that separately qualify as photographs. In a football game, an offensive lineman may be blocking the star defensive end, while a wide receiver catches a short pass across the middle of the playing field. Both actions could be stand-alone photographs.

### Cropping Methods

To crop a picture, you must mark off the unessential parts. This can be done by cutting, masking or using cropping L's.

**CUTTING.**— If the photograph or piece of artwork is expendable (you have several originals or the negative), you can do your cropping with a paper cutter. This is the most accurate method and the one most commonly used by ship and station newspaper editors.

**MASKING.**— When a section of a valuable photograph is to be reproduced, you may mask it by covering the picture face with a sheet of paper that has a window cut out to expose the desired area.

**CROPPING L's.**— Cropping L's (fig. 8-11) are useful tools when you are narrowing a photograph to its center of interest. Cropping L's are L-shaped cardboard or plastic devices, often black in color, used to eliminate dead space. When you place them over a photograph in

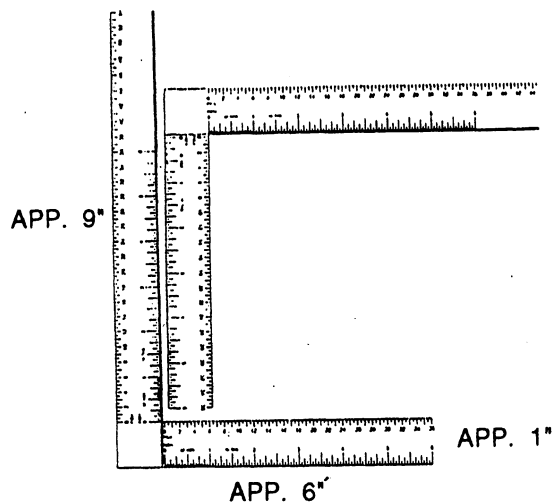

Figure 8-11.—Cropping L's.

the form of a rectangle, you can adjust them and see the effects of cropping before a crop is actually made.

### Photograph Dimensions

Before you can scale a photograph (explained later), you normally have to know the following three dimensions:

- Cropped width
- Cropped depth
- Reproduction width or reproduction depth

**CROPPED WIDTH (CW).**— The cropped width is the width of the photograph, in picas, columns or a local unit of measurement, after cropping is completed. In scaling photographs and artwork, width is usually represented in picas, columns or the local unit of measurement. Width is not usually represented in inches because most other horizontal measurements in newspaper design are in picas, columns or a local unit of measurement (such as ciccros).

**CROPPED DEPTH (CD).**— The cropped depth is the depth of the photograph after cropping has been completed. Depth is usually represented in inches, **not** picas or columns.

**REPRODUCTION WIDTH (RW).**— The reproduction width is the actual width of the photograph for reproduction. This is the predetermined space allotted for the photograph before cropping or scaling

takes place. The measurement usually is given by columns: two columns, three columns, and so on. You must know the standard width of the column and alley and the space between the columns (one pica, one-eighth inch, and so on) to get an accurate reproduction width.

You will use the three known dimensions (cropped width, cropped depth and reproduction width) to determine the unknown dimension, usually the reproductive depth.

**REPRODUCTION DEPTH (RD).**— The reproduction depth is the number of inches the photograph will be after it is enlarged or reduced to fit in the space allotted for it on the newspaper page.

On occasion, you may set aside a vertical space to fill on your newspaper page design. In such a case, you are using the cropped width, cropped depth and reproduction depth to establish the unknown reproduction width. This reverse procedure is used frequently in photo layouts where standard column widths may not apply.

### SCALING

Scaling is the act of either enlarging or reducing a cropped photograph or artwork to fit a hole on a newspaper page. Since you must first know the cropped dimensions, you cannot scale a photograph before you crop it. Once you know the dimensions, then you can scale the photograph to fit that hole snugly.

In scaling a photograph, you are trying to determine either the reproduction depth or the reproduction width. As you enlarge or reduce the photograph to reproduction width, the reproduction depth will change proportionately. Consequently, when you scale for reproduction depth, the reproduction width will change proportionately.

The two simple ways to scale a photograph or artwork to size areas follows:

- The diagonal method
- The proportional scale method

#### The Diagonal Method

The diagonal method of scaling a photograph or artwork is a mechanical procedure that does not require great mathematical skill or special tools. Diagonally

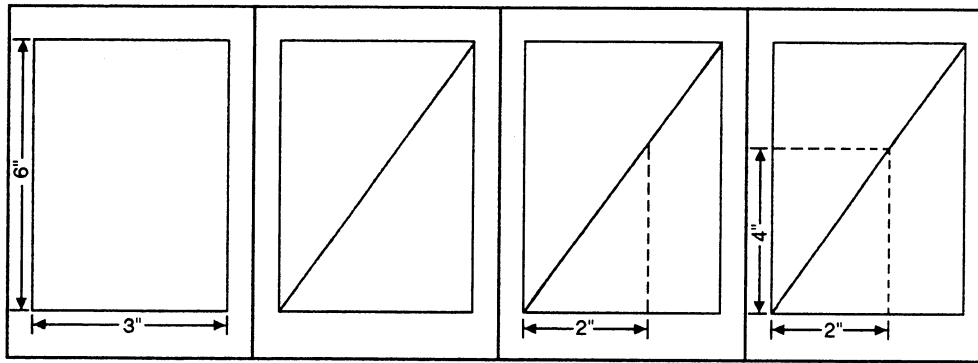

SUPPOSE YOU HAVE A PHOTO 3" WIDE AND 6" DEEP. YOU WANT TO REDUCE IT TO FIT A 2" COLUMN. FIRST, DRAW A RECTANGLE THE EXACT SIZE OF THE CROPPED PHOTO.

THEN, DRAW A DIAGONAL LINE FROM THE LOWER LEFT CORNER TO THE UPPER RIGHT CORNER.

MEASURE OFF 2" ON YOUR BOTTOM LINE AND DRAW A BROKEN LINE AT A RIGHT ANGLE FROM IT TO THE DIAGONAL LINE.

COMPLETE THE RECTANGLE AND MEASURE THE SPACE. IT IS THE AREA YOUR PHOTO WILL OCCUPY WHEN REDUCED.

Figure 8-12.—Scaling for reduction.

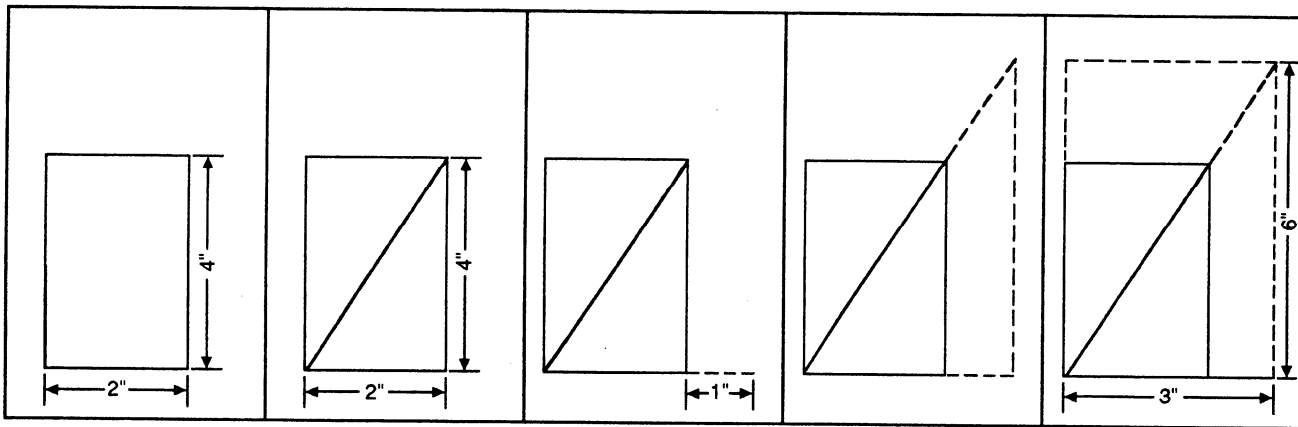

SUPPOSE YOU HAVE A CROPPED PHOTO 2" WIDE AND 4" DEEP, WHICH YOU WANT TO ENLARGE TO 1-1/2 COLUMNS WIDE (OR 3").

DRAW A RECTANGLE 2" X 4" AND RUN A DIAGONAL LINE ACROSS IT.

EXTEND THE BASE 1" WITH A BROKEN LINE.

DRAW THE BROKEN LINE AT A RIGHT ANGLE TO THE BASE LINE AS BEFORE. EXTEND THE DIAGONAL LINE TO MEET IT.

COMPLETE THE RECTANGLE AND YOU WILL HAVE YOUR NEW DEPTH.

Figure 8-13.—Scaling for enlargement.

scaling for reduction (fig. 8-12) includes five steps as follows:

1. On a separate sheet of paper, draw a rectangle that has the same dimensions as the cropped photograph/work.
2. Draw a diagonal line from the lower left corner through the upper right corner of the rectangle.
3. Measure from the lower left corner along the base line, the width desired for the picture. Make the base line extend to that point.
4. Draw a broken vertical line at a right angle from it to the diagonal line. Stop where the broken line and diagonal line intersect.

5. Complete the rectangle and measure the space. This is the area your photograph will occupy when it is reduced.

Diagonally scaling for enlargement (fig. 8-13) is slightly different from the procedure used for reduction. It contains the following five steps:

1. On a separate sheet of paper, draw a rectangle that has the same dimensions as the cropped photograph/artwork.
2. Draw a diagonal line from the lower left corner through the upper right corner of the rectangle.
3. Extend the base line with a broken line to the width desired for the picture.



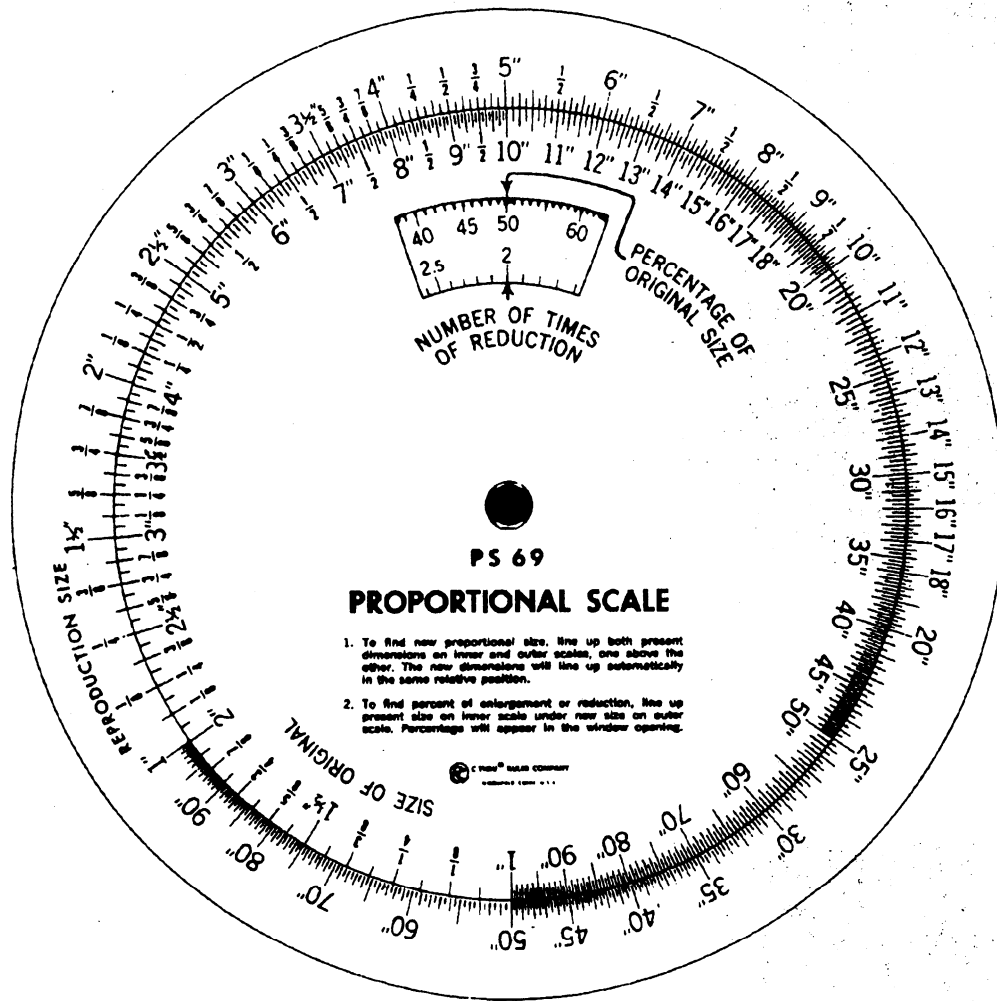

Figure 8-14.—Proportional scale.

4. Draw a broken vertical line at a right angle from it to the diagonal line as before. Extend the diagonal line to meet the broken line.

5. Complete the rectangle and measure the space. This is the area your photograph will occupy when it is enlarged.

### The Proportional Scale Method

Perhaps the most common way of scaling is the proportional scale method. The proportional scale (fig. 8-14) has a movable inner disk with a window mounted on an outer disk. Both disks have unit graduations from 1 to 100. Any unit of measurement can be used with the proportional scale.

To use the scale, you need to know three of the four measurements involved in scaling. You must know the

cropped width, cropped depth and reproduction width (or the reproduction depth if you are establishing a reproduction width.

Use your proportional scale to determine the reproduction depth in the following example:

**PHOTOGRAPH DIMENSIONS:** The cropped width is 18 picas and the cropped depth is 4 inches. It will be used in a one-column, 13.5 -pica-wide space.

**STEP 1:** Align the cropped width (18 picas) on the **inner** disk, with the reproduction width (13.5 picas) on the outer disk.

**STEP 2:** Find the cropped depth (4 inches) on the **inner** disk and read the reproduction depth opposite it on the **outer** disk. The reproduction depth is 3 inches.

The window on the inner disk displays the “percentage of original size.” In the preceding example, the photograph will be reduced to 75 percent of the cropped size. Percentages less than 100 indicate a reduced size; those higher than 100 mean the photograph will be enlarged. If you work for a CE or funded newspaper, your printing contract may stipulate maximum reduction and enlargement percentages and sizes.

### Marking Photographs

Photographs or other artwork must be marked appropriately so the publisher will know exactly what you want. Instructions are usually printed on the reverse of a photograph with a china marker. For instance, you mark a photograph “1-A, reduce to 24 picas by 5 inches” (width is always given first in art sizes). The “1-A” is a way of letting the publisher know you want the photograph to appear on page 1, fitted into a space designated “A” on the layout. It also tells the publisher that you have scaled the photograph, and when reproduced, it will occupy a space 24 picas wide and 5 inches deep; or you might simply use slugs to match a story with a related head, art and outline. Usually, an editor devises the “key” system to be used.

## TYPOGRAPHY

Typography is the art of printing with type. It involves the style, arrangement and appearance of the printed page. As editor of a ship or station newspaper, you should be familiar with a few important type-related terms.

### Printers’ Measurements

Type size is measured in **points**. One point is approximately one seventy-second of an inch. Twelve points equal one pica (remember — six picas equal one inch). Points are used to measure the height of a letter of type. The width of a line of type is given in picas. Most newspaper columns are about 12 picas (2 inches) wide. Type ranges in size from 3 to 120 points. Your stories will usually be printed in 8- or 10-point type. Most of your headlines will range from 12 to 36 points. The depth of a column of type or art (measured down the page) is given in inches. A **column inch** is one column wide and 1 inch deep; a photograph two columns wide and 3 inches deep occupies six column inches.

### Type Classification

Did you ever stop to think how many different kinds of handwriting you come across in a single day? Some are large and bold, some are weak, some small, some

clear and some are almost illegible. Type styles, called **typefaces**, are much the same.

The first concern of selecting a type is, of course, clarity. Type must be legible. However, there is more to it than that. Like handwriting, typefaces reflect certain characteristics, such as refinement, dignity, boldness or strength. Properly used, they can convey the feeling or mood of a message. They may be warm, brisk, dignified, modern or old-fashioned — whatever is needed to emphasize or suggest the thoughts expressed in copy.

Type can be used to attract the reader’s attention. The use of large boldfaces is one of the most effective ways of stopping the eye. Large, boldface type, however, is difficult to read. It should be limited to a few words and should be followed by smaller, more legible faces that invite reading.

Most kinds of type have both capitals and small letters. Publishers use the term **uppercase** for capitals and **lowercase** for small letters. These terms originated in early printshops where type was set by hand. The less-used capital letters were stored in an upper storage case and the frequently-used small letters in a lower one.

As early as the seventeenth century, publishers knew they had to organize their typefaces efficiently. They arranged their typefaces into main type classes. The six main classes of type (fig. 8-15) areas follows:

- Roman
- Gothic
- Text
- Italics
- script
- Contemporary

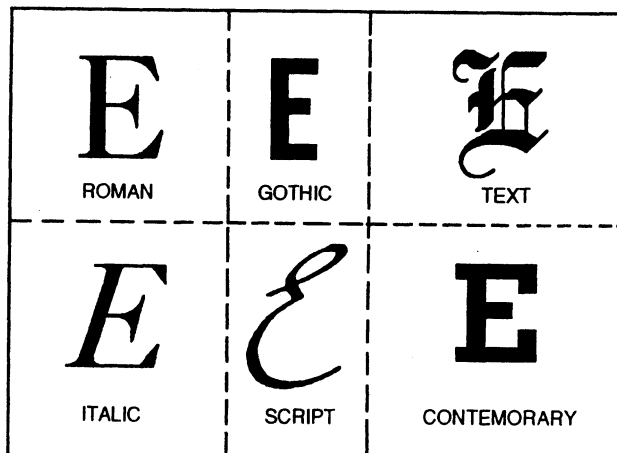

Figure 8-15.—The six main classes of type.

**ROMAN.**— Roman is the type most commonly used for the text of magazines, newspapers and books. It is chosen because most readers are familiar with it and because it is the easiest to read in smaller sizes and in lengthy articles.

Roman types are divided into two classifications: modern and old style. The chief difference between modern and old style roman is found in the serifs (the small cross strokes at the ends of the main lines of a letter). The old style letter has soft, rounded serifs, while the modern letter has heavier shadings and thin, clean-cut hairlines.

**GOTHIC.**— Study the difference between the roman letter and the gothic letter in figure 8-15. You will notice that where the roman letter is composed of a series of thick and thin lines, the gothic letter is constructed of lines of even weight. It has no serifs (known in the printing profession as “saris serif”); it is perfectly plain. Gothic type is popular for use on posters and as headlines.

**TEXT.**— Text type is sometimes referred to as “Old English.” Text was the first type style used in the history of printing. Although it is still used frequently, it is generally limited to a few lines of copy. As far as newspaper work is concerned, it should be limited to something formal, such as religious announcements, prayers, programs and invitations.

**ITALIC.**— In italic type, the letters are slanted and made to match almost every roman, gothic and contemporary type style in use today. Italic is used in text matter to show emphasis. Although italic was originally used for text, it was rather hard to read in lengthy articles and it is seldom used for this purpose today.

**SCRIPT.**— Script typefaces have little connecting links, or kerns, that combine the letters and give them the appearance of handwriting. Script is suitable for announcements and invitations.

**CONTEMPORARY.**— The past 50 years have been highly significant in typographic history. The old gothics have had their faces lifted, and new streamlined faces have appeared everywhere. Contemporary type refers to the thousands of modern, artistic faces used in a variety of ways, such as advertisements, labels on cans and boxes, display composition and television commercials. The example of contemporary type shown in figure 8-15 is bold (heavy block), but the same group contains lightface letters. In general, modern types feature more lightface than bold.



Figure 8-16.—Various typefaces in the Bodoni family.

### Type Families

From classes, type is further categorized into typefaces that are similar in design, though not exactly alike. These groups are called type families. Each type family has a name and a certain basic family resemblance. Many type families are named for their creators, such as Bodoni and Goudy. Some names come from regions or nations: Caledonia and Old English. Some type families include dozens of typefaces, all different in some way, yet all having general characteristics that unmistakably identify them as members of their particular family, such as the Bodoni family in figure 8-16.

### Type Series

The next type category refers to the weight, width and angle of type. This category is called type series.

When a series carries only the family name, with no adjectives indicating variations in width, weight or angle, assume that the type is normal. The usual distinction is between big letters (called display or headline type) and small letters (called body or text type).

## Type Font

Type font is the next category and has all the letters, numbers and characters necessary to set copy in one size of type. However, a modern newspaper uses either one or two families of compatible type to achieve variety in the series choice and point size.

## INITIAL LETTERS

Initial letters are large, ornate capital letters that are sometimes used at the beginning of a paragraph to dress up the page and add white space. They come in all sorts of styles. When an initial letter is used, the remainder of the word it begins is generally capitalized. You may use either regular capital letters or slightly smaller capitals of the same style of type.

## ORNAMENTS

Ornaments, such as stars (called “dingbats” in publisher’s lingo) and dots (called “bullets”): are used to add interest and beauty to a job. When using ornaments, you should always select something that goes well with the style of type you are using. Above all, do not overdo them. Fancy types and decorations should be used only if they make your newspaper page more effective. Decoration, just for decoration’s sake, was abandoned at the turn of the century in favor of simple harmony and balance.

## BORDERS

You should select borders with the same care you use to select a typeface, because the same general principles of typography apply. Figure 8-17 shows some typical ornaments and borders.

A study of type size and classifications could take up an entire book. The basics presented here will help you both in preparing an attractive publication and in conversing with the publisher. For all practical purpose, all you have to know is the answer to the question, “What kind of type is available to me?” A trip to your publisher or local printshop will give you that answer.

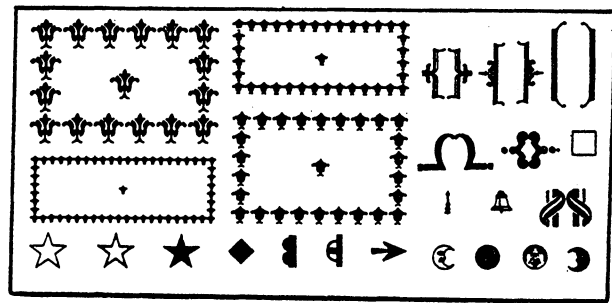

Figure 8-17.—Ornaments and borders.

## NEWSPAPER MAKEUP

*LEARNING OBJECTIVE: Recognize the objectives of ship or station newspaper makeup and the techniques used to meet them.*

“Newspaper makeup” is defined as the design of a newspaper page or the manner in which pictures, headlines and news stories are arranged on a page. The objectives of newspaper makeup areas follows:

- To indicate the importance of the news
- To make the page easy to read
- To make the page attractive

## FRONT-PAGE FOCAL POINT

Each page of a newspaper has a focal point — a point on the page to which the reader normally looks for the most important story. Any area can be the focal point, depending on the chosen design. Advertisements can also dictate the focal points of the inside pages of a newspaper.

On the front page of some daily newspapers, the focal point is often in the upper right-hand corner a now-dated practice that reflects the style of a bygone era. Americans, although trained to read from left to right and top to bottom, greatly altered this pattern for many years with respect to their newspaper reading habits. Through the use of banner headlines that extended more than half the width of the page, readers were trained to seek the upper right-hand corner of the front page. Newspaper readers begin their reading by following the banner headline across the page and continuing down the right-hand side of the page. Therefore, many newspaper readers have come to expect the most important story in each issue to appear or touch in the upper right-hand corner of the front page.

The right-hand focal point is not as important to makeup editors as in the past, since fewer newspapers use banner headlines on the lead story. However, many

newspapers still carry the most important story in the upper right-hand corner of the front page because of established practices.

Today, a large percentage of newspaper editors use the upper left-hand corner as the focal point. These editors think that readers, trained in school to read other literature from left to right, prefer their newspapers to be designed that way too. A few editors still use other areas, such as the upper center of the front page as the focal point. Only time will tell which is best, if indeed, there is a “best.”

### **INSIDE PAGE FOCAL POINT**

The focal point on inside pages is the upper left-hand corner if there are no advertisements. Therefore, the focal point is influenced by a newspaper reader’s natural sight tendencies and is not hampered by customs.

On inside pages with advertising, the way ads are placed on the page influences the position of the focal point. The focal point is always opposite the lower corner of the page that is anchored by the largest mass of advertising.

### **MAKEUP LINES**

You will use the following four basic types of “lines” in newspaper makeup:

- Vertical
- Diagonal
- Circular
- Horizontal

#### **Vertical Line**

The vertical line is used to get the reader to read up and down the page. The line is carried out on the page by displaying stories, headlines and pictures vertically on the page. It is characteristic of the makeup of newspapers in early America and is still used to a limited degree in making up newspapers today.

#### **Diagonal Line**

The diagonal line is used in newspaper makeup to get the reader to read through the page. The line is carried out on the page by displaying headlines and pictures so together they form a diagonal line from the upper left-hand corner to the lower right-hand corner of the page. Also, a page can contain a double diagonal by forming another diagonal in the opposite direction from the first. The diagonal line lends a sense of rhythm to

the page. It is characteristic of many of today’s newspapers.

#### **Circular Line**

The circular line is used in newspaper makeup in an attempt to get the reader to read around the page. The line is carried out on the page by displaying stories, headlines and pictures on the page so the reader sees each as being equally important. This creates a tendency on the reader’s part to read all the stories. The circular line is used to a limited degree in modern newspapers.

#### **Horizontal Line**

The horizontal line is used in newspaper makeup to get the reader to read back and forth on the page. The line is carried out by displaying stories, headlines and pictures horizontally on the page. The horizontal line is a post-World War II development and it is probably the most striking change in the appearance of newspapers in this century. It is a characteristic of many present-day newspapers.

## **NEWSPAPER DESIGN CONCEPTS**

*LEARNING OBJECTIVE: Detail the design concepts used in ship or station newspaper makeup.*

Successfully designing a newspaper page encompasses more than experimentation. It is actually a calculated art evidenced by the following five newspaper design concepts:

- Balance
- Contrast
- Rhythm
- unity
- Harmony

### **BALANCE**

In the balance concept, the page designer (hereafter referred to as the editor, although it may be any member of the newspaper staff performing this function) tries to balance heads against heads, pictures against pictures, stories against stories and artwork against artwork. This balance, however, is a relative balance, and it is not measurable but is something gauged in the viewer’s mind. Therefore, the editor has to sense, rather than measure, the balance for a page. This perception is one

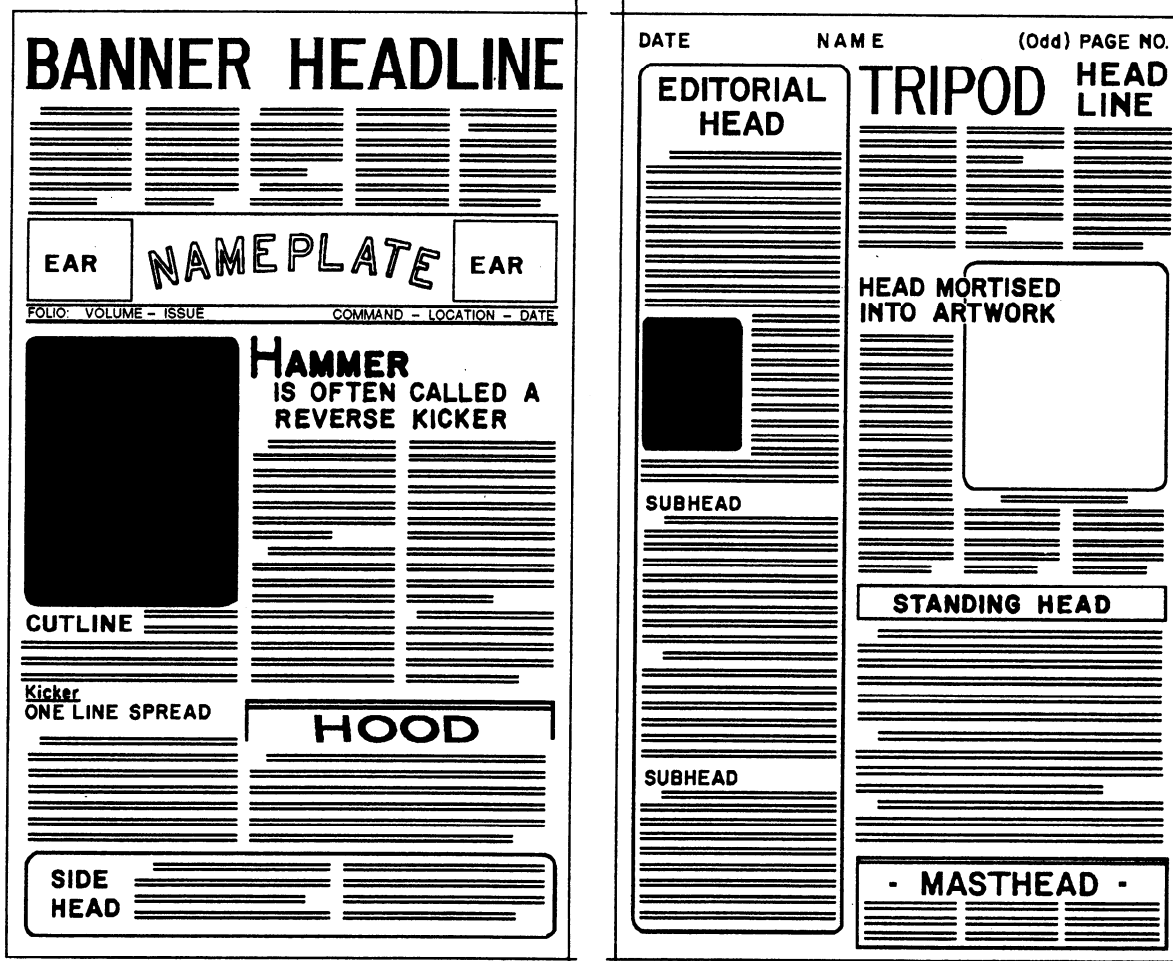

Figure 8-18.—Individual components of newspaper makeup.

developed by experience. The editor looks at the page

### CONTRAST

In the contrast concept, the editor strives to separate display items on the page so each gets the attention it deserves. The editor uses type, headlines, pictures, white space and color to achieve contrast.

For example, the editor can achieve contrast with type by using regular type with boldface type. Headlines also can be contrasted by using bold, blackheads or by displaying roman type with italic type. The editor can achieve contrast with pictures by using verticals with horizontals, small column widths with large column widths or dark and light photographs. Further, the editor can achieve contrast through color by displaying black type with color boxes, pictures and heads.

### RHYTHM

By using the rhythm concept, the editor tries to get the reader to move from one element to another element

on the page. Rhythm is achieved in newspaper makeup by staggering headlines, stories and pictures on the page.

### UNITY

The unity concept of newspaper makeup is used to tie the page together; therefore, the page is not divided into one, two or more sections.

A page that lacks unity is called a paneled page. You can avoid paneled pages by crossing the column gutters (space between columns) with headlines and pictures in the middle areas of the page.

### HARMONY

The harmony concept is used to give a newspaper a standard appearance from day to day. Harmony generally refers to typographic harmony. This means using one typeface for body type and a contrasting typeface for cutlines. Headlines should have the same typeface as the body type and maybe varied by weight and the use of italics on occasion.

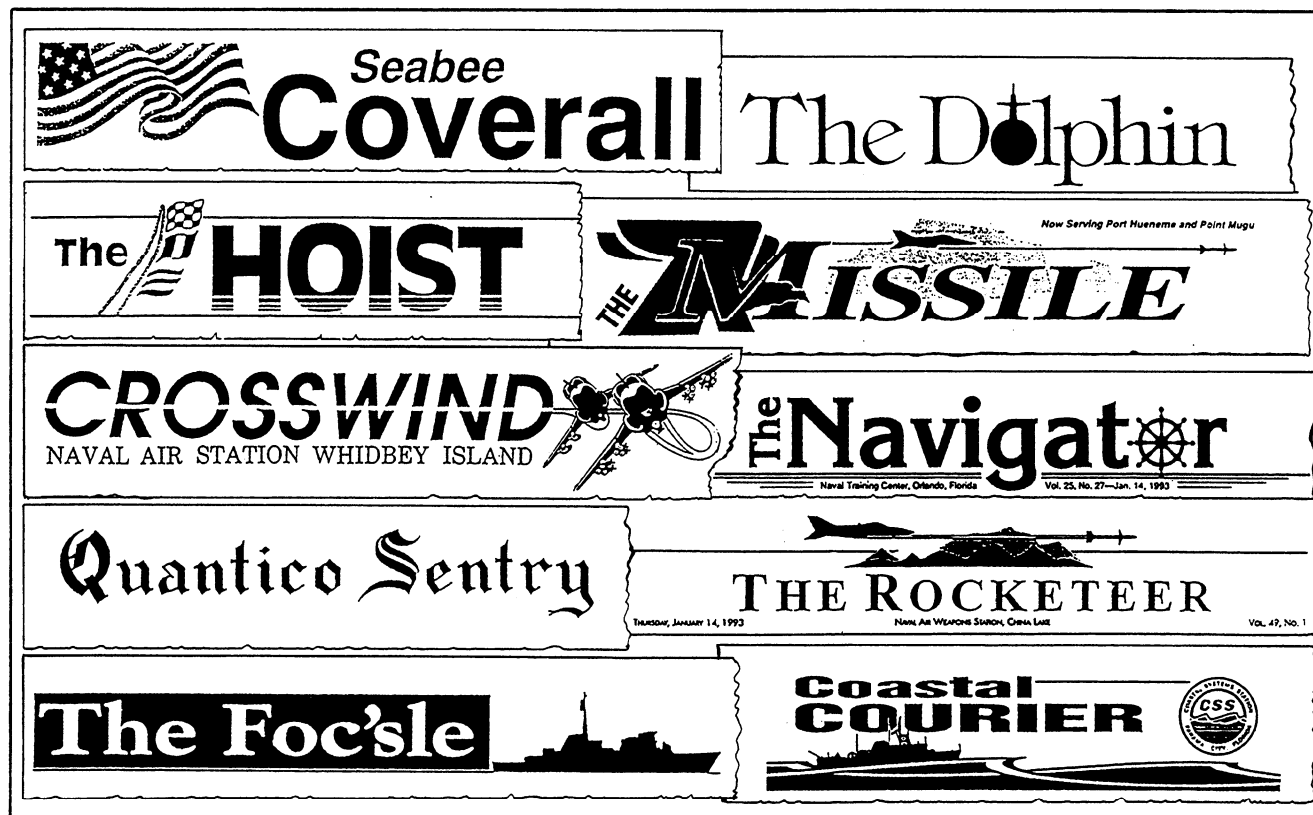

Figure 8-19.—Newspaper nameplates.

## ELEMENTS OF NEWSPAPER MAKEUP

*LEARNING OBJECTIVE: Identify the individual elements used in ship or station newspaper makeup.*

Thus far, all the subject matter in this chapter has dealt with the tools and materials available for presenting the reader of a ship or station newspaper with an attractive, interesting and convenient look at the news. Whether you achieve the desired product will depend on how these tools and materials are used in assembling your newspaper.

If you are the person responsible for laying out, making up or actually pasting up your newspaper, you should adopt a basic typographic plan or style. First, read all of the copy being considered for the newspaper. Study the pictures and other artwork closely. Visualize the news story message, or ideas, and the nature of the artwork as a whole. Decide the relative importance of the elements; then put the entire page together using the individual components of newspaper makeup (fig. 8-18).

Makeup creates recognition of a newspaper. A good editor varies the makeup in each issue, so the readers are

not bored with the newspaper. On the other hand, each page will resemble the previous editions enough so the reader can immediately identify it.

The following components help the reader identify a newspaper:

- Nameplate
- Flags
- Masthead
- Headlines
- Pictures
- Whites, grays and blacks
- Rules

## NAMEPLATE

The nameplate should be simple in design, attractive, and in harmony with the character of the paper. Its type should either harmonize or contrast with the headline type. The nameplate can combine type and artwork together. The artwork however, should not make the nameplate jumbled and hard to read. Figure 8-19 shows several examples of nameplates.

The nameplate can be made to float on the page. Although a nameplate that runs the entire width of the page can be made to float, a floating nameplate usually occupies two or three columns and is placed anywhere in the upper third of the page.

## FLAGS

A flag of the newspaper is a display used by a newspaper to indicate section pages or special pages, such as editorial, sports and family pages. Just like nameplates, a flag should not dominate its page and should appear above the fold. Flags can also be floated. (NOTE: Some authorities maintain that a flag is the same as a nameplate and identify a section head as a “section logo.” We do not.)

## MASTHEAD

A masthead of the newspaper is often referred to, incorrectly, as a nameplate. A masthead is a statement that should appear in every edition to give information about the publication.

The masthead of a CE or funded military newspaper includes the following elements:

- The name of the officer in command or head of the activity.
- The name of the newspaper and the producing command.
- The following statement: “The editorial content of this newspaper is prepared, edited and provided by the public affairs office of (command).”
- The name, rank or rate (if military) and editorial position on the newspaper staff of all personnel assigned newspaper production and editing duties. This is listed under the heading “(command) Editorial Staff.”
- The following disclaimer: “This newspaper is an authorized publication for members of the military services (add the words “stationed overseas” “at sea” or “and their families” if applicable). Its contents do not necessarily reflect the official views of the U.S. Government, the Department of Defense or the U.S. Navy and do not imply endorsement thereof.”
- The following disclaimer (for CE newspapers only): “The appearance of advertising in this newspaper, including inserts of supplements, does not constitute endorsement by the

Department of Defense, the U.S. Navy, (name of command) or (name of publisher) of the products and services advertised”

“Everything advertised in this newspaper shall be made available for purchase, use or patronage without regard to race, color, religion, gender, national origin, age, marital status, physical handicap, political affiliation or any other nonmerit factor of the purchaser, user or patron. If a violation or rejection of this equal opportunity policy by an advertiser is confirmed, the publisher shall refuse to print advertising from that source until the violation is corrected”

“Published by (name of publisher), a private firm in no way connected with the DoD or U.S. Navy, under exclusive contract with the U.S. Navy.”

For second-class mailing, postal regulations require a masthead to be within the first five pages of the newspaper. These regulations also require that the masthead contain the following information:

- Name of publication
- Date of issue
- Frequency of publication
- Issue number
- Subscription price (if applicable)
- Name and address of the publisher
- Second-class mailing imprint

The masthead of CE or funded newspapers must be printed in type not smaller than six point. Additional information on mastheads may be found in *PA Regs* or *Ship or Station Newspaper/Civilian Enterprise (CE) Publications*, NAVPUBINST 5600.42 series.

## HEADLINES

Headlines, or simply heads, contribute to all five concepts of newspaper design — balance, contrast, rhythm, unity and harmony.

The headline for one story should be separated from that of another. Heads that appear side by side (called “Tombstones”) could be read as one head and confuse the reader. Tombstoning also prevents each head from gaining its share of attention.

When headlines and pictures are used together, they should be placed so the reader is not confused by their positions. You should not place a picture between a



headline and a story, because the reader might begin reading the outline thinking it is the first paragraph of the story.

Heads of the same column width should not be placed lower on the page than a smaller one, or higher on the page than a larger one. This does not mean that the bottom of the page cannot contain a large multicolumn head. It only means that heads of the same width should decrease in point size as they descend the page.

Do not run stories out from under their heads. This creates a readability problem by confusing the reader about where to find and finish reading the rest of the story.

A story can be wrapped (to continue a story from one column to the next) under its main head, or lead, to achieve variation. A story is always turned to the right from its main part. A turn running above the headline of the story could confuse the reader and cause the individual to abandon the item.

A story requiring a “jump,” or continuation, to another page should be split in midsentence, never at a period of a paragraph. For example, “(Continued on page \_\_, col. \_\_) will direct the reader adequately. The jumped portion should carry a brief head, or key word, taken from the main head to identify it as a continuation. The “jump head” should be keyed to the same type style and face, although it seldom will be in the same type size, as the original headline. Never jump a story on a hyphenated word, or carry over the last line of a paragraph.

## **PICTURES**

Readability studies have shown that pictures are one of the most popular elements in a newspaper. For that reason alone, important pictures should be large and positioned in a manner that maximizes their display.

Pictures of two-column widths or more should be placed on a page so they stand or hang from something that gives them support. A picture can stand on a headline, another picture or the bottom of the page. A picture can hang from a headline, another picture or the top of the page. A picture of two-column widths or more should not float in copy, but a one-column-wide picture or smaller can float in copy.

Pictures and headlines that are not related should be separated by more than a rule, if the possibility exists that, when placed together, they are humorous or in bad taste.

Avoid any clashing items. For example, do not place an accident story next to a mortuary advertisement. (Discuss the placement of advertisements with your editor or the CE newspaper publisher.)

If you run two pictures, two boxes or a picture and a box side by side, except in cases where the subjects are related, they tend to cancel each other out. It is best to separate unrelated artwork with body type.

Reader’s eyes have a tendency to follow the line of sight of people in pictures. Therefore, if people in a picture look off the page, readers will tend to look off the page. To prevent the reader from doing this, the main subjects in pictures should look straight ahead or into the page. This also holds true for pictures showing action. The motion should go toward the center of the page whenever possible. This reader tendency can be used to your advantage. The line of sight and motion can be used to guide the reader’s eye through a page.

Try to avoid running pictures on the horizontal fold of a newspaper, because the area along the fold becomes distorted once the newspaper has been folded.

Do not give a picture more display space than it deserves, especially a “mug shot” (portrait-type, close-up photograph of an individual). Mug shots can float in copy, but it is best if they stand on or hang from something. If a mug shot floats, it is best to float it within a sentence in a paragraph. Mug shots should be accompanied by at least a name line for identification. By omitting the name line, the reader is forced into trying to identify the individual in the picture.

“Thumbnails” also are used in making up newspaper pages. The term refers to half-column mug shots. A thumbnail is best used when it looks into the story or directly out of the page. A name line, in most cases, should also be used with thumbnails.

## **WHITES, GRAYS AND BLACKS**

A newspaper page is made up of varying degrees of whites, grays and blacks. Some pages may contain other colors. A good editor strives for relative balance of colors on a page and will not let any color dominate the page. You will not have any problems with white pages, black pages or any other colored pages; your concern is staying away from gray pages.

There are many ways to relieve grayness, or gray-out, which is created by large areas of body type. One way is to use multicolumn pictures to break up columns of type. Another way is to use thumbnail photographs.

Type also can be used effectively to relieve grayness. To breakup gray areas in a long story, you can set selected paragraphs in boldface type, if used sparingly. Another method of breaking up long gray stories is to use boldface subheads set about two points larger than your body type size. A third method of using type to break up grayness is to use boldface, all-cap lead-ins. This method is particularly effective in matter set in wider measures. In two-column matter, the first three to five words of the paragraph containing a lead-in can be set in boldface and all caps, and in one-column matter, the first one to three words of the paragraph can be set in boldface and all caps.

The paragraphs to be set in any of these boldfaced methods should be the paragraphs that introduce anew element into the story or ones that contain information of more than usual interest. Two paragraphs using the same boldfaced method should not be run side by side because they tend to cancel each other out. Note that the use of boldface type is not favored by the editors of contemporary newspapers as much as by the editors with traditional leanings. (More about traditional and contemporary designs will be presented later in this chapter.) “Modem” editors rely on the use of different design concepts to eliminate large gray areas on their pages and consequently have little use for boldface type, except possibly as subheads.

Other useful devices in breaking up grayness are initial letters (mentioned earlier in this chapter), kickers and hammerheads (covered in Chapter 9) and sandwiches.

A sandwich is a device for handling “reefers” (references to a related story on another page). It is a small, sideless box made with the same rule used for regular boxes. The reefer type in the sandwich should be set in boldface and not be indented. No headline is needed and it should be brief, containing not more than two or three lines.

The sandwich should be placed about 2 1/2 inches deep into the story. Presumably, this practice gives the reader enough time to become interested enough in the subject being addressed to want the related information being offered. The use of the sandwich assumes the reader will immediately turn to the related story, read it and then return to the original story and continue reading below the sandwich.

Special effects can be obtained with special art, such as boxes and ornaments (art borders around individual stories, announcements and ads or the entire page). These devices are also effective gray breakers but should be used sparingly, so their use does not create a cluttered effect. In using boxes, you can indent a story on all sides and use a box of white space all around the

story. You can also indent on all sides of a story and then use a ruled box. Dingbats, once in vogue, are now considered old-fashioned and are shunned by modern editors. White space provides margins to frame your page. Side margins should be the same width, but bottom margins should be about one-fourth wider than your top margins to give your page a lifted look. White space is also used to give breathing room around headlines and pictures in much the same manner as margins frame the page. However, you should make an effort to avoid the appearance of trapped white space. White space should run to the outside of the page.

## **RULES**

Rules are commonly used typographic devices in newspaper makeup. Properly used, they separate unrelated items and unite related ones. The two types of rules used are the column rule and the cutoff rule.

### **Column Rule**

The column rule is a vertical, thin line that runs from the top to the bottom of a newspaper page. Use the column rule to separate columns of type and to separate unrelated items, such as photographs and stories, from the rest of the page. Part of a column can be deleted to indicate that the items joined are related

### **Cutoff Rule**

A cutoff rule is a horizontal, thin line that runs across one or more columns of a newspaper page, depending on the width of the items to be separated or united. A cutoff rule is used to separate unrelated items, such as boxes, photographs, multicolumn headlines and advertisements, from the rest of the page. A cutoff rule helps the reader’s eye turn the corner from where a story ends in one column to where it begins in the next column, except when the story wraps from the bottom of a page. Then no cutoff rule is needed

## **ADDITIONAL MAKEUP CONSIDERATIONS**

Newspapers have other elements that usually appear in each issue and other makeup devices that are used to design newspaper pages. Some of these are described in the following text.

### **Widows**

Avoid having widows at the tops of columns. A widow is an incomplete line, as one that ends a

paragraph. When there is a widow, carry two lines to the new column or page.

### **Wrapping Copy**

When you wrap copy, wrap at least 1 inch of copy into the next column. That is approximately six lines of type. Studies have shown that anything less than an inch of copy lacks eye appeal.

When you wrap a story, split paragraphs at the bottom of the column, when possible, to indicate to the reader that the story continues in the next column.

### **Folio Line**

A folio line is an identification line of the newspaper on each page. The folio line on the front page is different from those on inside pages, as described in the following sections.

**FRONT-PAGE FOLIO LINE.**— A front-page folio line joins the nameplate and consists of the volume number (the number of years the publication has been in print), the issue number (the number of issues published within the present year), command, location (city and state), and date of publication. It does not carry a page number and is usually separated from the flag by a border and a cutoff rule or by two cutoff rules.

**INSIDE PAGE FOLIO LINE.**— An inside page folio line generally runs at the top of each page. It also can run as part of a flag that appears on special pages or within the masthead on the editorial page. The inside page folio line consists of the publication date (left corner of the page), name of the newspaper (centered) and the page number (right corner of the page). An inside page folio line is normally separated from the rest of the page by a cutoff rule, but as you can see in figure 8-15, this is not a requirement.

### **PAGE PERSONALITY**

The quality of the layout and makeup of the inside pages of your newspaper should receive the same attention as the front page of the newspaper. Readers should not be shortchanged once they leave the front page of a newspaper. Special pages, such as editorial, family and sports, should have their own personalities.

#### **Editorial Page**

The editorial page probably is the least read of all the inside pages. The reason can be attributed particularly to makeup. Most editorial pages are very

dull and very gray. A good editorial page should be as different in makeup from other inside pages as possible. Use pictures and artwork, white space, odd-column sets and other elements of makeup to give the editorial page its own special traits.

#### **Family/Leisure Page**

An appealing family/leisure page features delicate type, white space and artistic designs. Use large and dramatic pictures to complement articles on off-duty leisure activities.

#### **Sports Page**

An attractive sports page contains plenty of action pictures. Be sure to include masculine type, white space, odd-column sets and large, bold headlines to complement the flavor of this popular newspaper page.

#### **Other Pages**

Inside news and feature pages should be as attractive as front pages within the limitation of available space. Use pictures, white space, multicolumn heads, artistic designs and groupings of related news and features on these pages.

### **PICTURE STORY LAYOUT**

*LEARNING OBJECTIVE: Analyze the main points of a picture story layout.*

The picture story layout (also addressed in Chapter 12) is a special challenge to a layout editor. A good picture story is a logical, well-organized, self-contained unit in which each part has a specific function.

The format used to layout the picture story depends on space limitations and what you, as the layout artist, consider the most attractive arrangement. With an imaginative photographer, the number of interesting picture stories your publication can produce are unlimited. Once you have been provided with a variety of interesting, action-packed pictures suitable for reproduction, the layout is up to you. Let your experience and good judgment be your guide in determining the arrangement of pictures, headlines, cutlines, text and borders.

A good picture story layout (fig. 8-20) can add immeasurable interest and attractiveness to your publication. Like feature stories, picture stories can be made up in advance and used as either regular attractions or to spice up occasional issues.

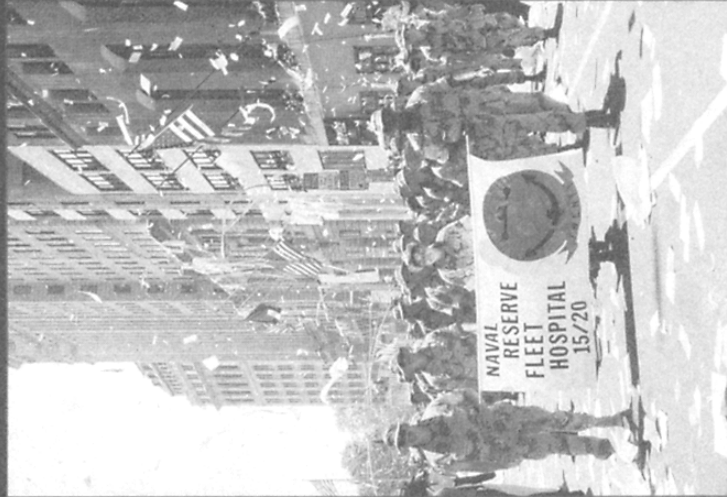
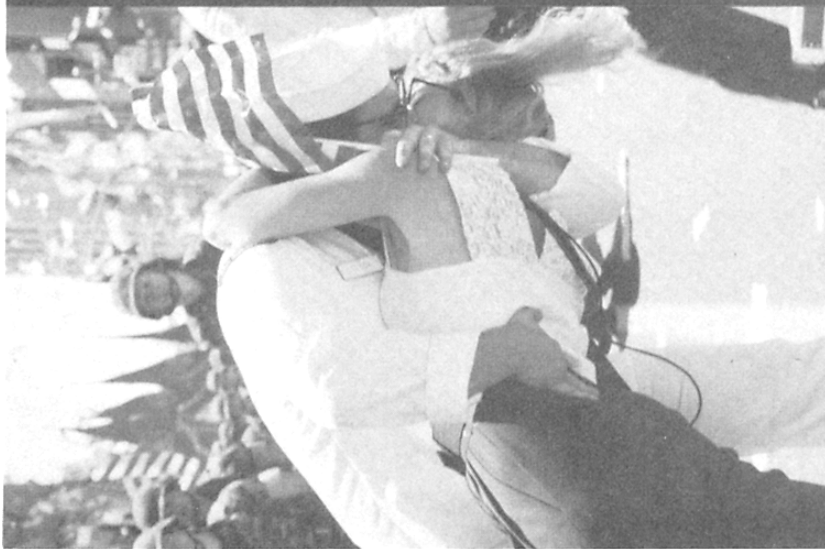

# America celebrates

Photos by JOI Lee Bosco

Not since the end of World War II has America shown the outpouring of affection and gratitude displayed this summer. Parades and victory celebrations began as soon as winter gave way to spring. This year may be recalled as the year America's pride resurfaced. And who received the cheers and appreciation? All our service men and women were given a hero's welcome.

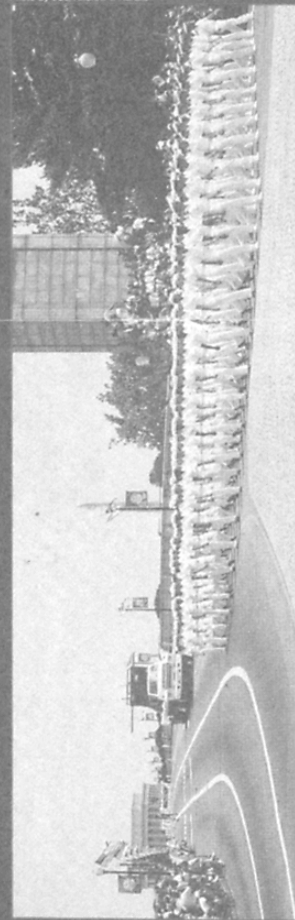

Photo by JO2 Andrew I. Karala

24

ALL HANDS

SEPTEMBER 1991

25

Figure 8-20.—Picture story layout.

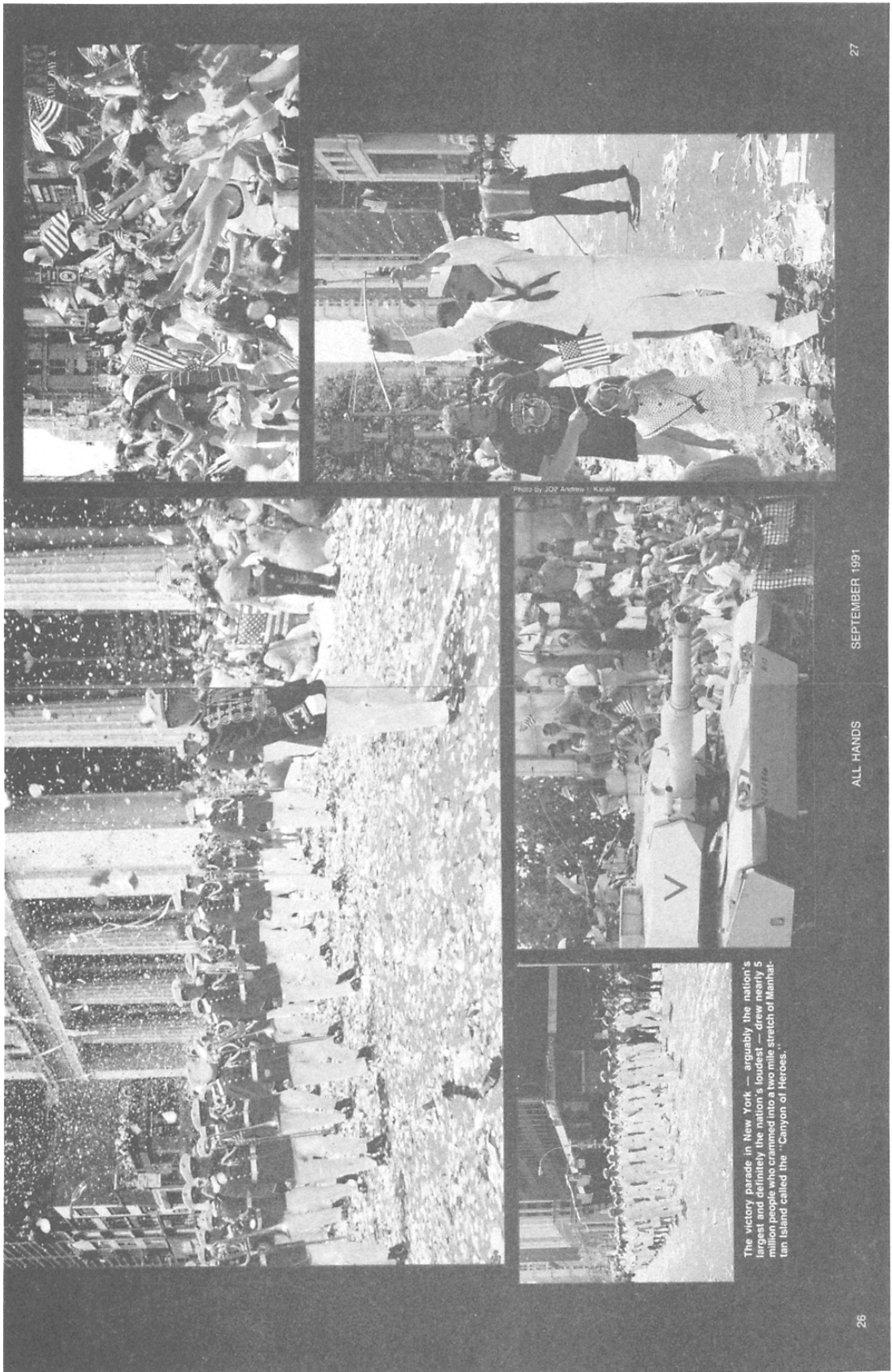

The victory parade in New York — arguably the nation's largest and definitely the nation's loudest — drew nearly 5 million people who crammed into a two-mile stretch of Manhattan Island called the "Canyon of Heroes."

Figure 8-20.—Picture story layout—Continued.



CW03 Ed Bailey

Photo by JO2 Andrew I. Karalis

Photo by JO2 Andrew I. Karalis

**Figure 8-20.—Picture story layout—Continued.**

In the following text, we cover the major points of assembling a picture story.

## **NUMBER OF PICTURES**

The number of pictures required to make up a picture story depends on the importance and complexity of the subject. However, an odd number of photographs should be used in a double-truck layout. The term *double truck*, also called a centerfold, is used for a two-page layout made up as one page, with the “gutter,” or normal margin between the two pages, eliminated.

## **LEAD AND LAST PICTURE**

The most important picture of any picture story is the one that opens the story — the lead picture. This picture has a double function. First, it must attract the reader’s attention and make that person want to know more about the subject. For that reason it should be the largest in your picture story. Second, it must show the subject and theme of the story in a graphically interesting form.

Almost as important as the lead picture is the last picture. The closing picture should show the reader the significance of the subject to the storyline or theme.

## **BODY OF THE STORY**

The body, which shows important scenes of the subject in action, must be varied and lively in visual rendition and presentation. To provide this variety and liveliness in a story, the photographer should start with a good script, excellent change of pace in coverage techniques and a quick eye for unexpected developments during actual shooting. By careful study of major picture magazines, photographers, as well as layout artists, can gain a great deal of insight into the type of pictures being used in picture story assignments.

## **PICTURE DIRECTION**

Some photographs, because of their compositional direction, are natural right-hand or left-hand photographs. This means that the photograph is a natural to be used on the right or left side of a page, photo display or picture layout. Picture stories are viewed in the same manner in which we read, from left to right. Therefore, the lead photograph should be one that has the subject facing toward the viewer’s right and the ending photograph facing toward the viewer’s left. When

possible, all lead and ending photographs should be taken twice: once with a left-hand direction and again with a right-hand direction. By duplicating these shots, you provide flexibility for layout. All photographs have direction: left, right, upward, downward, straight in or straight out of the page.

## **HEADLINES, CUTLINES AND TEXT**

Headlines, cutlines and text have double functions. First, they give the reader facts that supplement the pictures editorially. Second, they serve graphically as elements of composition that contribute to the organization of the picture story.

## **PROOFREADING**

*LEARNING OBJECTIVE: Identify the purpose of proofreading newspaper galley proofs and recognize the standard proofreader’s marks.*

Proofreading is one of the final steps in the printing process (from the standpoint of the JO, not the publisher).

After the publisher has typeset your copy, you will receive the initial copies of your typeset stories. These copies are called “galley proofs,” “galleys” or just plain “proofs.” The galley proof name originated in the printing profession many years ago. Proofs of long rows of type came direct from the “galleys,” or trays, in which the type sits until make-up time at the printshop.

## **WORKING WITH GALLEY PROOFS**

Your job is to read through the galley proofs — every word and every punctuation mark — to make sure there are no errors and that they conform to the original copy. If an error is found, it will be connected at the expense of the publisher (in a commercial printshop). However, the cost of any changes in the original copy must be borne by your command, since they result in extra work for the publisher.

In photo-offset printing, you are likely to be given the complete paste-ups of pages (publisher’s reproducible, sometimes called repros) for proofreading. Proofreading is usually done by all members of the newspaper staff and printshop personnel. The reason is obvious; checking the content of your publication is part of your job.

PROOFREADER'S MARKS			
⊙	Insert period	Cap.	Caps—used in margin
↗	Insert comma	≡	Caps—used in text
:	Insert colon	C+sc	Caps & small caps—used in margin
;	Insert semicolon	≡	Caps & small caps—used in text
?	Insert question mark	lc.	Lower case—used in margin
!	Insert exclamation mark	/	Lower case—used in text
=/	Insert hyphen	wf.	Wrong font
∨	Insert apostrophe	○	Close up
↔	Insert quotation marks	⊗	Delete
—	Insert 1-en dash	⊗	Close up and delete
—	Insert 1-em dash	⊗	Correct the position
#	Insert space	⌋	Move right
ld>	Insert lead	⌋	Move left
hill	Insert virgule	⌋	Move up
∨	Superior	⌋	Move down
^	Inferior		Align vertically
(/)	Parentheses	=	Align horizontally
[/]	Brackets	⌋⌋	Center horizontally
□	Indent 1-em	H	Center vertically
□	Indent 2-em	↓	Push down space
¶	Paragraph	~	Use ligature
no ¶	No paragraph	sp. #	Equalize space—used in margin
tr	Transpose—used in margin	vv	Equalize space—used in text
~	Transpose—used in text	✓	Decrease space
sp	Spell out	stet	Let it stand—used in margin
ital	Italic—used in margin	.....	Let it stand—used in text
—	Italic—used in text	⊗	Dirty or broken letter
bf.	Boldface—used in margin	run over	Carry over to next line
—	Boldface—used in text	run back	Carry back to preceding line
sc.	Small caps—used in margin	Copy out	Something omitted—see copy
≡	Small caps—used in text	2u?	Ⓟ Question to author
rom.	Roman type	^	Caret—General indicator used to mark exact position of error in text.

Figure 8-21.—Standard proofreader's marks.

A
E
C
O
O

^ WASHINGTON — The Defense department  
 may propos<sup>^</sup> legisla<sup>^</sup>tion this year  
 ^ that would give 60,000 more single

Figure 8-22.—Proofreader's marks using the book system.

## PROOFREADER'S MARKS

Proofreader's marks (fig. 8-21) and copy editing marks are, for practical purposes, the same. The main difference is in their usage.

There are two popular methods of noting proofreader's marks on galley proofs: the "book" and "guideline" systems. Both systems are covered in the following text.

### Book System

In using the book system (fig. 8-22), you make two marks to correct each error: one under the error and one

in the margin. Place a caret (A) under the error. In the margin, place the appropriate proofreading symbol level with the line in which the error occurs.

### Guideline System

In the guideline system (fig. 8-23), you place the appropriate proofreading symbol in the margin and draw a line from it to the error. This is the most common form of using proofreader's marks.

Check with your editor or associate editor to see which proofreading method is preferred.



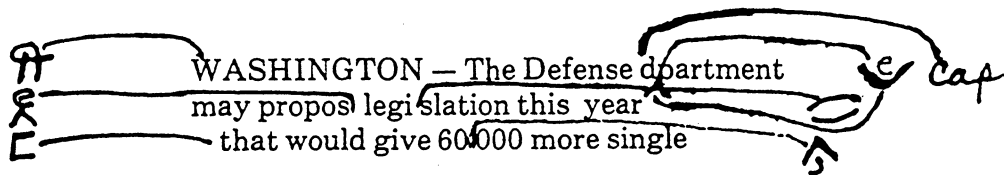

Figure 8-23.—Proofreader's marks using the guideline system.

## WHAT HAPPENS AFTER PROOFREADING

After the corrections have been made and you have approved the galley proofs, the publisher takes and assembles type, along with photographs and other art, into pages according to the layout plan you submitted. From these, the publisher makes page proofs — and usually gives you a final chance to make sure there are no errors. Make sure headlines are with the proper stories, stories “jump” to the correct pages, paragraphs are in proper sequence and cutlines are under the correct photographs. Check the body type too. Sometimes a slug gets misplaced or jumbled, but routine typesetting errors should have been caught long before you reach this point. You will make a permanent enemy of the publisher if you start making unnecessary alterations.

After the final proofs are reviewed and approved, the publisher produces a “blueline” version of the newspaper for the editor to review. The blueline is a replica of the newspaper in reverse and is comparable to a blueprint. After the blueline is approved by the editor, the newspaper is published and distributed. Additional information on the blueline can be found in the *JO 1 & C TRAMAN*.

If you work on a newspaper staff, you will do a lot of proofreading. For this reason, you should ask for a tour of the newspaper printing plant. Observing the printshop in operation makes you more aware of the publisher's problems than you might otherwise be and helps you give clearer, more useful directions for what you want on the galley proofs.

## FRONTPAGE PATTERNS

*LEARNING OBJECTIVE: Identify the patterns used to design the front page of a ship or station newspaper.*

So far in this chapter, we have concerned ourselves with the tools and the basic principles of producing a newspaper. In this final section, we will examine the patterns followed in designing the front page of newspapers to give you, as a potential or current editor, a starting point for designing your own.

The following are three different meanings to the word *design* in the newspaper lexicon:

1. It refers to the basic format of the entire newspaper.
2. It refers to the arrangement of news on an individual page after that page has been made up.
3. It is used as a slightly altered form of the word *makeup*.

“Makeup” consists of building a page, element by element, until all the space on a page is filled, but “design,” using the third definition, means to plan for the total structure of a page before any layout is done.

Logically, it requires more time to “design” a page than to “makeup” one. Consequently, when the pressure of a deadline is present, your most important concern is meeting that deadline. However, when there is ample time for preplanning, as is the case with most weekly issues of a newspaper, you should “design” the front page, if not every page.

The primary purpose of designing a page is to **make it easier to read**. This enables your readers to rove the material faster, and as a result, it encourages more of them to read all that is written. Remember, unread copy serves no usefull purpose. When you design your front page, it is important for you to note that there is no “best” pattern, only different patterns. Any design repeated too often loses any freshness it may have had, and of itself, becomes a deterrent to the enjoyment of the reader. Consequently, a good editor will vary those patterns from issue to issue.

Not unlike other aspects of our culture, newspapers have changed over the years and are still changing. A number of editors, however, remain devoted to what is called “traditional” style and continue to design their publications accordingly. Others have opted to follow or to lead the way in developing modem journalistic trends by producing newspapers with a “contemporary” style. Undoubtedly additional styles will be forthcoming as tastes continue to change. Meanwhile, the traditional patterns currently in use are covered in the following text.



(A)



(B)



(C)



(D)

Figure 8-24.—Traditional front page design patterns: (A) formal balance, (B) quadrant, (C) focus (brace) and (D) circus (razzle-dazzle).

## TRADITIONAL PATTERNS

The term *traditional patterns* (fig. 8-24) refers to the following front-page design strategies:

- Formal balance
- Quadrant
- Focus (brace)
- Circus (razzle-dazzle)

### Formal Balance

In formal balance design (fig. 8-24, view A), the page is vertically divided in half. Each element to be placed on one side of the vertical center line is duplicated by the same treatment of elements at the same point on the opposite side. In this type of design, there are two lead stories; both are usually of equal importance.

Formal balance design forces the news into a formula and does not distinctly tell the relationships, values and relative worth of the news. It also creates an artificial look, with the makeup being the dominant factor on the page. It is considered “visually boring” by modern editors. Most editors still using formal balance vary its use often enough to escape the deadening effect of sameness.

A variation of formal balance is the dynamic (informal) balance design. It follows the same fundamental principle as described in the formal balance design, except when you progress below the horizontal fold of the page. This is where the exact duplication of the formal balance design is abandoned.

Since the dynamic balance design gives the editor more latitude in designing the page, it is slightly more pleasing to the eye.

### Quadrant Design

In quadrant design (fig. 8-24, view B), the page is divided into four quarters, and a dominant, eye-stopping element (picture or headline) is placed in each quarter so that diagonal quarters balance each other. The diagonal line, then, is the type of line used. In this type of design, the lead story is placed in the upper left-hand corner or the upper right-hand corner depending on which is being used as the final point of the page.

Quadrant design formalizes quarter-page balance and is useful for giving equal display to equally important stories.

### Focus (Brace) Design

In focus (or brace) design (fig. 8-24, view C), the page is made up by placing headlines and pictures on the page to form a diagonal line from the upper left-hand corner to the lower right-hand corner. Then a strong typographical display is used in the upper right-hand corner for sharp emphasis. The diagonal line is the type of line used here. In this type of design, the lead story is placed in the upper right-hand corner.

A letter or figure pattern is discernible in the focus design. Note in figure 8-24, view C, that the figure “7” is apparent in the pattern. Also note that attention is “focused” on the corners by the stair-step arrangement of headlines that appear to “brace up” those corners.

Focus design is useful when you have one story that outweighs any other in news value. It also is useful in getting readers to read through the page.

### Circus (Razzle-Dazzle) Design

In circus (or razzle-dazzle) design (fig. 8-24, view D), the page is made up by placing elements on the page so all elements scream for the reader’s immediate attention. Therefore, there is no focus of interest on the page.

The circle is the type of line used in the circus design. In this type of design, the lead story is placed in the upper left-hand corner or the upper right-hand corner depending on which you are using as the final point of the page.

Circus design is characterized by immense type, large art masses arrayed in unorthodox shapes and positions, use of colored ink for headlines, use of white space, movement of the nameplate to a minor spot on the page, use of widely varying headline typefaces with emphasis on the boldest weights, and preference for multicolumn displays.

Because it is difficult (if not impossible) to make up a page so no one item stands out above any other, circus design is probably the most difficult design to use successfully.

## CONTEMPORARY PATTERNS

While not really offering a new concept in newspaper style, the following design concepts represent a break from the pure traditional patterns:

- Functional
- Horizontal

- Modular
- Total/Single Theme
- Grid

## Functional Design

In functional design, the page is made up according to no set pattern. It is based on presenting the day's news in the way that will be most appealing and convenient to the reader. The vertical line, diagonal line, circular or horizontal line could be the type of line used in fictional design. In this type of makeup, the lead story is placed in the upper left-hand corner.

Functional design always lets the news dictate the layout and is characterized by very few banner headlines. It often has stories that run over the nameplate and uses short and floating nameplates, kickers, down-style headlines and several pictures. Functional design uses no decks on headlines and avoids jumps. (Headlines and headline terminology will be covered in detail in Chapter 9.)

## Horizontal Design

In horizontal design (fig. 8-25), the page is made up by placing elements on the page so the majority of the elements present a horizontal display. In this type of makeup, the lead story is placed in the upper left-hand corner or the upper right-hand corner depending on which one you use as the final point of the page.

Horizontal design provides strong horizontal units with a few vertical displays for contrast. It is characterized by large multicolumn headlines, large horizontal pictures, white space and odd-column measures. This format came about as a result of readability studies which indicate that readers estimate their reading time of horizontal copy blocks to be about half that of vertical blocks.

Horizontal modules of headlines, copy, photographs and even the flag give the page a strong horizontal thrust.

## Modular Design

In modular design (fig. 8-26), pleasing blocks (modules) of vertical and horizontal rectangles are combined. Irregular story shapes are avoided to maintain this modular look. An earmark of a classic modular format is a strong vertical chimney (a panel running at least half the depth of the page) on the left or right side of the page. This chimney may contain news

briefs, a complete story or only a photograph and outline. Highly flexible and uncluttered, this design gives the editor a wide range of formats for visual impact.

## Total/Single Theme Design

In total/single theme design, strong emphasis is placed on a single, important story or issue. Both emphasize simplicity with strong visual impact.

The total page design may contain a large photograph (or line art) covering the entire area, a single story and photograph, or a billboard (dominant photograph with page reefers to major stories).

The single theme page design is essentially similar, but normally does not contain stories or reefers. If you use this design strategy, make sure you stick with the theme and develop it on subsequent pages. You might have a single-page feature, two or three major stories about various aspects of the theme throughout the newspaper, a photo feature or any combination of these elements.

Figure 8-27 shows an example of a total design, while figure 8-28 shows a single-theme design.

## Grid Design

The grid design (fig. 8-29) consists of a page of modules of varying sizes with the grid lines formed by the spaces between columns and the spaces separating stories.

A grid design is a pattern of intersecting lines, forming rectangles of various shapes and sizes. The objective of this concept is to take advantage of contemporary artistic principles to give a page the "now look" found in today's magazines. Lacking the flexibility of other patterns, the grid design cannot be combined with other makeups but must stand alone as a single unit. Its intersecting lines are highly structured and carefully placed to divide a newspaper page into clean-cut, simple-appearing modules whose total effect is contemporary. Stories are squared off and designed into vertical or horizontal shapes with the division of space on the page always arranged in unequal portions. The page might be divided (from left to right) into two and four columns or one and five columns, but never three and three.

The top of the page is never top heavy as is the case in traditional designs. While story placement is still based on the importance of giving a particular story featured treatment, the grid design allows all other

FEBRUARY 4, 1990  
Vol. 1, No. 1, Norfolk, Va.

# The Flagship

**Wasp Wave**  
Students visit for amphib's helm changes  
Story, Page B1

## Joint operations stressed in post-cold war



Smaller crises and smaller forces have put Navy-Marine joint operations at the forefront of naval strategy.

By JOE ROBERT B. COOK

You may not have noticed, but it's a new world out there. If you look closely you'll see the military is getting smaller. Day by day, bases are closing and some personnel are given necessities to separate Troops and ships are increasing their areas of operation, but not their personnel strength.

Operations are changing, too. In the old world, the major threat was an East-West confrontation. Now, in the new world, we face smaller problems, but we have smaller forces to deal with them. That's where the Special Purpose Marine Air-Ground Task Force comes in, or SPMAAGTF.

"It's clear that we live in a world of great change, and we're going to have to adapt," said Chief of Naval Operations Adm. Frank B. Kelso. He was on board USS Theodore Roosevelt (CVN-71) to observe the birth of SPMAAGTF.

Kelso said in the last 40 years, the conflicts in the world have changed how the Navy will operate in the future. He said the SPMAAGTF will be used as a flexible tool to handle small crises throughout the world.

The SPMAAGTF is supposed to move more than 500 Marines. The first of its kind, it is a force capable of performing missions such as the evacuation of hostages from a foreign country, boarding and searching large hostile ships, and performing raid missions.

Rear Adm. Jay L. Johnson, Commander Carrier Group 2, said budget cuts have forced the military to find ways to combine missions. "It's something called an adaptive force package," he said.

"In layman's terms, it would be similar to a theater commander that has to write a prescription. He's writing a prescription for a specific ailment, and that ailment might be in Somalia, Yugoslavia or Libya, who knows? Nonetheless, he's writing a prescription for a specific ailment. When he goes to the shelf of medicine, he needs a lot of variety. SPMAAGTF is going to be one of the new drugs, if you will, on that shelf that he can respond with."

The Marine force embarked on board Roosevelt for the second time Jan. 14 to practice several exercises. The first was a non-combat evacuation exercise, or NCO. It began Jan. 23.

"There has been an international incident," said Lt. Timothy S. Schipke, the intelligence officer on Roosevelt, at the start of the NCO. He said the scenario the Marines followed was a quick evacuation from the U.S. Embassy in the pseudo-country of Redona, which was actually Camp Lejeune, N.C.

"Redona is similar to a third-world nation. In the northern part of the country, there are rebel forces trying to take over the local government. Americans are being attacked and notes are being torn out," said Schipke.

The NCO was launched in waves of helicopters lifting off Roosevelt while it was enroute in the Atlantic near the coast of North Carolina. When the industry units landed in Camp Lejeune, they had their work cut out for them.

"It all started when we hit the deck," said Lance Cpl. Patrick G. Cardone, squad team 2 leader. "We secured the landing zone. The other platoons took care of the people who had to be evacuated from the embassy. After they took off from the LZ, we took their position at the embassy, and secured it for the night. We extracted the next morning."

Cardone said the toughest part of the operation was the waiting

around, because there was really no threat to his team. "It was just a matter of having patience," he said.

The next day of operations brought a new twist to the NCO. One of the helicopters "crashed" about five minutes after take-off from the LZ. The simulated wounded were placed on other helos and brought to the flight deck of the Roosevelt, where they were quickly treated and returned off to the ship's medical department. Fortunately, it was just a drill to train the ship's personnel.

The Marines also got to do something different on Jan. 24. A raid was scheduled to attack a weapons cache in a Redona rebel stronghold.

In a Marine raid, the key word is "deceit." That's just what they did. Or, Lance Cpl. Colin T. Hunt's words, "We went up in the helicopters, and flew in a column to the LZ. We destroyed what was there, then we got out." The end result was 23 out of 26 enemy Redonians killed, two wounded and one captured.

Evaluation officers rated the performance of the SPMAAGTF at the completion of each exercise. The major fact-finding part of the mission was to find out how the two services worked together.

Sean O'Keefe, the former Secretary of the Navy, said this forging together of the Navy and Marines is what America is looking for. "It's the new Navy that will face the new challenges of the future. The experiments we are working on aboard Roosevelt are exactly what we need to face these challenges," he said.

One SPMAAGTF member agreed with the O'Keefe. "They're looking for ways to make cuts in the Navy and Marine Corps, and they also need a multi-service force," said Cpl. Dale M. Hoyle, an electronics countermeasures technician. "It will work. We both do our tasks slightly different ways, but the job always gets done."

Photo by PETER KO. Lance Cpl. Craig Potter mans an M-249 SAW as India Company's automatic rifle man during a raid exercise conducted from the USS Theodore Roosevelt as part of the Special Purpose Marine Air-Ground Task Force.

## Recycled paint store paints 2 kinds of green—money, environment

Sometimes it costs more to throw something away than it costs to find another use for it. In building SP-83 on the Naval Air Station, Larry Odietus runs a unique store that not only saves the Navy money, but reduces the need for hazardous waste disposal.

By DEBRA PRINZ

Larry Odietus, collateral equipment manager for Naval Air Station Norfolk, has been running the Recycled Paint Store for over five years in building SP-83. The Recycled Paint Store houses paint that is beyond shelf life for its intended use, but is new enough that it can be used for other purposes.

For example, a can of paint that has exceeded its shelf life which

was labeled to paint an aircraft part, can no longer be used for that purpose. However, that same can of paint can be used to paint office chairs, tables, walls, etc. Not only does the store stock paints, but

also hydraulic fluids and tube oils. Most of the paint, hydraulic fluids and tube oils are donated to the Recycled Paint Store from commands on Naval Air Station Norfolk.



Photo by JILL O'NEIL. Sargeant N. Prinsler. Collateral Equipment Manager Larry Odietus provides paint at no cost to many Hampton Roads commands.

"We have tanks come to the Recycled Paint Store not only from the Naval Base, but Little Creek and Oceana to see if we have the type of paints they need before they buy it brand new," said Odietus.

"And how much does it cost someone to get paint from the store? Absolutely nothing. We don't charge anyone for the paint, but you have to be military or Department of Defense civilian and use the paint only for official business purposes," said Odietus.

Basically, giving the paint away is more cost effective for the Navy. The average cost for a one gallon can of latex paint is \$12. The cost for the Navy to dispose of that same gallon of latex paint is \$18. For every gallon of paint that is given away, the Navy realizes significant savings.

"Our first 13 months of operating the paint store, we saved over a million dollars in disposal costs," said Odietus.

The Recycled Paint Store only accepts paint cans that are not

damaged, with each item labeled for easy identification to the customer. Also, the store follows the same DOD regulations for storage of hazardous materials as other facilities.

The last inspection general inspection the Recycled Paint Store had was in November, and the inspector found no discrepancies. That's not bad for a one-man operation.

## NSC's refurbished paint budget, earth-friendly, too

By PAULA REIER

Saving money and protecting the environment were two of Naval Supply Center Norfolk's goals that led to an ambitious pilot program to reduce the amount of paint being disposed of in the Hampton Roads area.

On Dec. 30 at NSC's Paint Meet, Capt. William T. Brown, NSC Norfolk's commanding officer, accepted a requisition form from Cmdr. Max Baumgartner, the supply officer of USS Doughty D. Eisenhower for the first gallon of refurbished

oil-based paint. The reduced priced paint will be used by Eisenhower's deck division under the careful supervision of their leading chief petty officer, BMC(SW) David Morgan.

NSC Norfolk, working with the Naval Surface Warfare Center in Dahlgren, Va., recently tested several randomly selected cans of oil-based paint, burned into disposal and confirmed what NSC's Hazardous Material Minimization and

Reuse sec PAINT, Page A8

### INSIDE THIS WEEK'S FLAGSHIP



USS Hayler (DD-997) sailors man fire hoses during recent refresher training at Naval Base Guantanamo Bay, Cuba. Following an extensive yard period for the Norfolk-based destroyer, the Hayler crew progressed from a lowly 26 percent on the ship's first condition zebra check to a resounding 97 percent in just a few short weeks of reftra at Gitmo. That kind of improvement and the end result prompted Hayler crew members to declare: "Battle E in '93."

News of the Fleet, Page A8

### THIS WEEK'S TIP

#### Civilian care costs

Active duty personnel may be tempted to get medical care at civilian clinics. Military members may use civilian doctors, but some conditions apply. Except for emergencies, the only civilian care the government will pay for is that care which has been preapproved and prearranged through a military medical facility. Active duty members should seek counseling with naval medical personnel prior to seeking civilian care. More information on non-naval medical care is available through the branch medical clinics or Naval Hospital Portsmouth at 988-7754.

Figure 8-25.—Horizontal design.

# Sports & Fitness

## Gym Shorts

### Sign-up for sports at gym

It's not too late to sign up for basketball's noon-time over-thirty league, weekend three-on-three competition, or racquetball's challenge ladder. For more details, call the Athletic Office at 452-6403 or visit Wenzel Gym.

### Holiday Rock-In set for Dec. 4-5

The Morale, Welfare and Recreation Department is sponsoring an all-night Holiday Rock-In from 9 p.m. Dec. 4 to 7 a.m. Dec. 5 in the Corry Recreation Center, Bldg. 3738. Tickets are \$9 in advance or \$10 at the door and may be purchased from the Bowling Center cashier. Admission includes a hamburger or cheeseburger, french fries and soft drink; musical entertainment provided by D.J. Connection; hourly door prizes; free pool on 10 tables and an 8-ball tournament; free bowling beginning at 10 p.m.; games and prizes; and free coffee and doughnuts for breakfast.

### Bowling party package available at Bowling Center

If you are planning a birthday party, reenlistment party, school party, retirement party, or just a fun time out with a group of friends, have your next party at the Corry Lanes Bowling Center. The party package includes three hours of bowling, personalized bowling pin to keep, medium soft drink for \$5 each person or \$6 per person with pizza, with a six-person minimum. There's no charge for the honored guest. Reservations are required. To schedule your next party, call 452-6387.

### Fitness club offers gift certificates

Give the gift of fitness for Christmas with a Golden Anchor Fitness Club gift certificate. Monthly, quarterly and yearly certificates are available. A Golden Anchor Fitness Membership is the perfect gift for a friend or relative. For more information, call Don McKeen, fitness coordinator, at 452-6403.

### Health tip

The human spine never takes a break. It is constantly in use—even when you are standing or sitting. Pounds of pressure are exerted against the spine just to keep you upright. Reward the old workhorse with exercise, muscle conditioning, good posture, and careful lifting.

## Captain's Cup basketball under way

By Maggie Mayence

The 1992-93 Captain's Cup basketball season is under way with 12 teams entered this season: Company K, Hospital Red, 505 Division, NSGD, Hospital Black, Support, USAF/USA, Saufley, 50 Department A, Barrin Field, 50 Department B, and 30 Department.

As you read through the list, you may have noticed that the CPOs did not field a team for this event. This makes the already close race for the Captain's Cup season even closer. Hospital has

110 points, CPOs have 100, and Saufley has 99. Basketball and racquetball are the only two sports left to go in this race.

The basketball season will break for the Christmas and New Year leave period Dec. 18, 1992, and will pick back up Jan. 4, 1993.

MWR Athletics is having sign ups for a noon-time over-thirty basketball league. All interested personnel should come by or contact the gear issue room in the gymnasium by calling 452-6196. You don't have to be a pro to play, just come out to have some fun!



PH2 Greg Russell  
A1C Chris Dearing of the Army/Air Force combined team goes up for a jump shot over two Saufley defenders. Saufley defeated the Army/Air Force team 56-50.

## Blue Angel Marathon set for February

Naval Air Station Pensacola, the cradle of Naval Aviation, will again host the annual Blue Angel Marathon and 5K run. The marathon, a qualifying race for the Boston Marathon, is scheduled for Saturday, Feb. 27, 1993. The "official marathon" of the U.S. Navy is open to both military and civilian runners, both teams and individuals.

"According to *Florida Running* magazine, the Blue Angel Marathon is the largest marathon in Florida," said Judith Bagshaw, director of marketing the public affairs for Morale, Welfare and Recreation Department, NAS Pensacola. The 1992 races had 1,562 participants with runners from all over the United States and numerous foreign countries.

The course is a 26.2-mile clearly marked route, ranging from flat to rolling terrain. Medical personnel will be available throughout the course, with aid stations every two miles. Both the marathon course, which winds through NAS and historic Pensacola, and the 5K are sanctioned by The Athletic Congress (TAC).

Top overall male and female

marathon finishers will receive round-trip airfare to the 1993 Boston Marathon. Awards will be presented to the first five finishers in 14 age/sex groups, the first male/female Masters and Grandmasters, and the first three in the wheelchair division. Each marathon finisher will receive a memento of the 1993 Blue Angel Marathon and all entries will receive a T-shirt and poster.

For the first year, the United States Military Sports Association will be a Blue Angel Marathon sponsor. Their sponsorship is allowing for significant expansion of the military awards.

Entry fees for the Blue Angel Marathon and the 5K run are \$18 and \$12, respectively, if received before Feb. 24, 1993. Late registrations are \$24 and \$15; day of race fees are \$30 and \$20. For additional information and entry forms call Judith Bagshaw, (904) 452-2843 or Jim Curry, (904) 452-4391 or write: Blue Angel Marathon, c/o Morale, Welfare and Recreation Department, Bldg. 632, Naval Air Station, Pensacola, FL 32508-5000.

## Fitness Spotlight:

### SA Thomas Ciccarelli

Seaman Apprentice Thomas Deyo Ciccarelli is highlighted in our fitness spotlight this issue. He has been a student at NTTC Corry's CTO "A" school for 10 weeks.

SA Ciccarelli started working out in high school, where he ran cross-country and track. His interests were usually with the shorter distances, but his coaches always urged him to run the two-mile.

Ciccarelli's workout consists of either running, step aerobics, or the rowing machine and bicycle at lunchtime. He also likes to use strictly his own body weight to work out with such exercises as pushups, sit-ups, and handstand presses.

"Working out has always given me a sense of control over what happens in my life," said Ciccarelli. "Running has become a lifetime fitness program for me. I no longer compete for awards, it's strictly a natural motivation for a healthy body and lifestyle."

SA Ciccarelli taught funk step-aerobics for the past year and has a bachelor's degree in exercise science. "Working out is very important to me," he said. "When I haven't worked out for a while, I can feel my stress and anxiety level increase."

"My advice is there's always enough time in the day to enjoy 40 minutes of physical exertion of some kind. If you can't find the time, then something else needs to be cut out. I've always found that affording the time is not the problem, but rather, managing time properly."



SA Thomas D. Ciccarelli

Naval Technical Training Center  
Corry Station, Pensacola, FL 32511-5000

to:

Figure 8-26.—Modular design.

# SEABEE CENTER COURIER



Vol. 29 No. 43

Gulfport, Home of the Atlantic Fleet Seabees

November 5, 1992

**"When  
commitments  
collide"  
page 2**

**Stinger's  
reopening  
a  
success  
page 5**

**Regiment  
sheds  
new light  
on FEX  
page 8**

**Tax change  
could affect  
Federal  
employees  
page 12**

**Russ'  
Review  
page 14**

## 'Beavers' take on homeport DRT



See Center for more on DRT

Photo by PH2 Dave Casper

Figure 8-27.—Total page design.

# Bluejacket

---

Vol. 50 No. 47  
Thursday, November 26, 1992  
NAVY MEMPHIS



Figure 8-28.—Single-theme design.



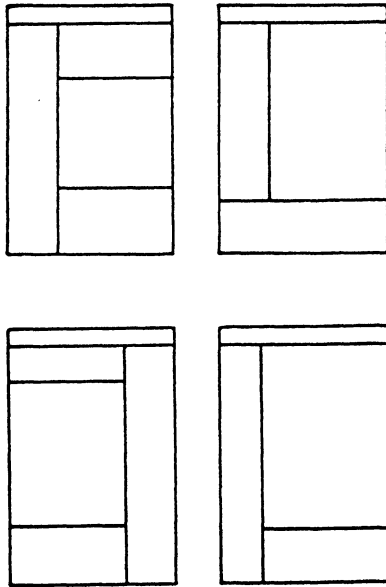

Figure 8-29.—Grid design.

stories a better chance of being seen, since they are not buried or lost to the reader.

#### FINAL NOTE

Remember that the front-page designs covered in this chapter are only suggestions for what you can do with your newspaper. A pure sample of a formal page layout is nearly impossible to find, because experienced editors are not concerned with producing textbook examples. Rather, their interest is in presenting the news of a particular day in what they believe is the best and most interesting manner. Most often that is done by combining features of several page patterns.

As you gain experience as a layout editor and become familiar with established patterns, you can try out new ideas as they come to you. Trust your instincts and do not be afraid to experiment. A controversial page design is better than a dull, uninviting one.



## CHAPTER 9

# WRITING HEADLINES AND CUTLINES

You have just delivered a story to your associate editor that is arguably the best you have ever written. The lead is first-rate, the body copy is flawless and the ending is textbook

However, the story might vanish into obscurity on any newspaper page if the accompanying headline does not entice or inform the reader.

Well-written headlines grab the reader's attention, convey clear, concise thoughts and dress up the publication. Poorly written headlines can mislead, confuse and even embarrass the newspaper staff, command and Navy. Headlines must be free of libelous statements and must not contain violations of security, accuracy, policy and propriety.

A reader often decides whether to read a story based on what the headline says. A headline tempts the reader to dig into the story. To do this, you, as a headline writer, must have a sense of what will attract the reader. You must have abroad vocabulary and enough versatility to say the same thing several ways to make sure the headline will fit the space allotted for it on the page.

In the following text, we cover the essentials you need to become an effective headline writer. Additionally, we examine the methods used to write cutlines (the explanatory matter supplementing photographs) in the final third of this chapter.

### HEADLINE EVOLUTION

*LEARNING OBJECTIVE: Evaluate the evolution of the headline.*

The first American newspaper headlines were nothing more than labels. A large capital letter, called an "initial letter," may have been used to set off the first paragraph of each story. Sometimes the front-page headlines were one-line labels showing the origin of the news (England, France, Spain).

By the time of the Revolutionary War, American newspapers had made some progress in the art of writing headlines, but not much. A full-page account of the battle between the *Bon Homme Richard* and HMS *Serapis*, for example, might have been carried under a 10-point, Old English typeface headline which read as follows:

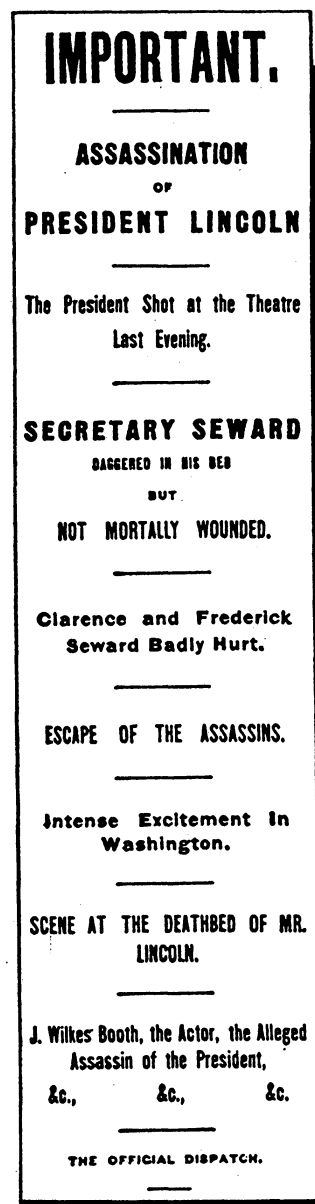

Figure 9-1.—Multidecked headline from the *New York Sun* following the assassination of President Lincoln.

### Epic Sea Battle

An epic sea battle between the *Bon Homme Richard* and the HMS *Serapis* was waged on the high seas. . . .

During the Civil War, American newspapers began putting more information in their headlines, but their form was very different from what we are accustomed to today. Figure 9-1 shows a multidecked headline

carried by the *New York Sun* over the story of the assassination of President Lincoln in 1865.

Toward the turn of the century (during the Spanish-American War), technical improvements and a circulation war between the Hearst and Pulitzer newspapers in New York helped speed the adoption of multicolumn headlines. Important stories were introduced by screaming headlines (banners) across the entire page, followed by as many as eight or more related heads. Sometimes headlines occupied more space than their stories.

However, by the end of World War I, many editors began experimenting with headlines that were more streamlined and more compact. They found the space they saved could be used more advantageously for news and advertising — especially advertising, which them as now, paid the bills.

## HEADLINE FUNCTIONS

*LEARNING OBJECTIVE: Identify the functions of the headline.*

The modern trend in headlines is toward simplicity. Most newspapers now use heads that say what has to be said in a minimum of words. A good headline conveys the news in a story and the significance and meaning behind the story. It never implies more — and should not say too much less — than what actually appears in the story. It does not contain misleading suggestions and it does not leave false impressions.

An easy way to remember the functions of the headline is through the acronym **HEADS**:

**H** - Heralds the days news; tells what is of importance.

**E** - Entices the reader with essential or interesting facts.

**A** - Advertises the most important story by size or placement on the page (the most important stories are displayed at the top of the page).

**D** - Dresses up a page with typography; helps make design attractive.

**S** - Summarizes the story with a “super” lead; tells what the story is about.

## HEADLINE STYLES

*LEARNING OBJECTIVE: Recognize the various types of headline styles.*

There are several ways in which you can display headlines. For style variation, your headlines can be set in all-caps, caps and lowercase or downstyle. These methods are covered in the following text.

### ALL-CAPS HEADS

The all-capital letter headline style is almost extinct. All-caps heads, while they are easier to write than others, are the most difficult to read. To test this premise, read the following paragraph:

AS THIS PARAGRAPH DEMONSTRATES, THE ALL-CAPITAL SETTING IS NEITHER EFFICIENT FOR THE READER, NOR PLEASING TO THE EYE. WILLIAM RANDOLPH HEARST USED TO HAVE KEY GRAPHS IN HIS EDITORIALS SET ALL-CAPS. INSTEAD OF MAKING THE POINT EMPHATICALLY, AS HE INTENDED, SUCH SETTING ACTUALLY CUT DOWN THE READERSHIP AND ITS IMPACT.

Even the most patient, attentive and skilled reader will be blinded by the onslaught of all those capital letters. By the way, did you spot the typo?

### CAPS AND LOWERCASE HEADS

A widely used headline style is the uppercase and lowercase head. In this headline style, all words, other than articles, conjunctions, and prepositions of fewer than four (and sometimes five) letters, are set with the first letter in caps and the others in lowercase.

### DOWN-STYLE HEADS

The down-style head usage has increased in popularity in recent years. In down-style heads, the first letter of the first word — and the first letter of any proper noun — is set as a cap, and all other letters are lowercase. Down-style is presented in the way persons are taught to read and write. The style is visually attractive and enhances the readability of the line. By design, it lacks the numerous capital letters in a headline which serve as “eye stoppers.”

# Local pilot had unique role in Desert Storm

Story and photo by  
Vance Vasquez

Two years ago, Jan. 17, the United States and other United Nations coalition forces joined together to liberate occupied Kuwait from Iraqi forces.

Operation Desert Storm affected the lives and careers of thousands of military personnel by participating in the first Congressionally-authorized war since World War

II.

One such person, Cmdr. Robert E. Noziglia Jr., aircraft maintenance officer of Naval Air Weapons Station, Point Mugu, had a unique role in Desert Storm.

Noziglia was interviewed by Ambassador Edward W. Genhum, Jr., the U.S. designate for Kuwait, in Washington D.C., Sept. 15, 1990. He was selected to head the reconstruction of the Kuwait Air Force.

A Kuwaiti 747 airliner

was used to transport 86 contract technicians along with their supplies to Khamis Mushayt, Saudi Arabia. They departed from Andrews Air Force Base, Md., and arrived in Saudi Arabia, Sept. 16, 1990.

"The technicians were both retired Navy and Marine Corps personnel with A-4 Skyhawk experience," said Noziglia.

When Iraq invaded Kuwait and overwhelmed the

small country, only a small portion of the Kuwait Air Force was able to escape into Saudi Arabia. A total of 18 A-4KU and two TA-4KU skyhawk, attack aircraft along with 15 F-1 Mirage fighters and three L110-30 (C-130) transport aircraft were saved.

The Kuwait Air Force arrived with no support facilities available; no equipment, tools or aircraft log books, which were left be-

hind in Kuwait.

"The aircraft was unique since no other country operated A-4KU Skyhawks; we were able to assemble new log books from information obtained from the United States," said Noziglia.

After the technicians arrived 34 days later, the A-4KU's were moved from Khamis Mushayt and were forward-deployed to Dhahran, Saudi Arabia. The A-

4KU's were stationed far away from Iraq to avoid any possible airstrikes before the United Nations mandate for Iraq to leave Kuwait was ordered. The Kuwait Air Force was integrated with The Royal Saudi Air Force (RSAF) under a single command.

The coalition forces of France, Qatar and Kuwait operated the F-1 Mirage.

(Cont'd on page 5)

Figure 9-2.—Banner head.

## Expanded dependents dental plan nears implementation

(ARNEWS) — More details were set for the expanded Dependents Dental Plan, in a workshop held by the Office of the Civilian Health and Medical Program for the Uniformed Services (CHAMPUS).

Enrollment in the expanded benefits plan will be automatic

for all sponsors with eligible family members, even if the sponsor had previously declined enrollment or had disenrolled from the basic plan.

However, sponsors stationed outside the continental United States when the extended plan begins will not be automatically enrolled, unless they are

already enrolled in the basic plan.

There will be a 90-day disenrollment period for those who wish to decline the new

program. Some issues still remain open, such as the monthly premium, co-payment cost and a premium rate for junior soldiers.

Figure 9-3.—Crossline head.

### HEADLINE FORMS

*LEARNING OBJECTIVE: Identify the most common headline forms.*

Headline forms constantly come and go. Regardless of the form, the most common headlines are easy to read, easy to write and easy to set. Some of the most common headline forms are explained in the following text.

#### BANNER HEAD

The banner head (fig. 9-2) is set the full-page width at the top of a news page to draw attention to the lead story or that particular page. If you run a banner head above the flag or nameplate, it is called a skyline. A streamer applies to the widest and biggest multicolumn head on a page, regardless of whether it is the full width.

#### CROSSLINE HEAD

The crossline head (fig. 9-3) is very similar to a banner headline. Although it does not always span the full width of the page, it does cover all the columns of the story to which it pertains.

### FLUSH LEFT HEAD

The flush left head (fig. 9-4) is a two- or three-line head with each line set flush left. The lines do not have to be equal in width or set full. The white space at the right is considered enhancing, because it allows "air" into the otherwise stuffy column spaces. Flush left is the most commonly used head today.

## NEX gift certificates great holiday gift idea

Do you have a hard time selecting the right gift for everyone on your holiday list? Do you spend hours guessing at the proper size and color? If this is you, your holiday shopping just got a lot easier.

Navy Exchanges have just introduced a new worldwide NEX gift certificate. The new gift certificates are available and redeemable at any Navy Exchange around the world. They come in three convenient denominations — \$10, \$25 and \$50. Select the amount that's right for you.

Navy Exchange gift certificates aren't just for Christmas either. They make the perfect gift for birthdays, weddings or any other special occasion.

Since gift certificates are good at any Navy Exchange, at home or abroad, they are the gift that's easy to send to friends and family wherever they may be located. However, the person receiving the certificates must be an authorized Navy Exchange customer in order to enjoy using the gift certificates.

Navy Exchange gift certificates are easy to buy, too. Just see the customer service representative at your local NEX.

Pick up Navy Exchange gift certificates for everyone on your list this season. They are the gift that always fits. Your Navy Exchange makes holiday giving and holiday shopping a pleasure.

Figure 9-4.—Flush left head.

<p><b>Saufley sprinters display best efforts at area track meet</b></p>	<p> Lorem ipsum dolor sit amet, consectetur adipiscing elit, sed diam nonummy nibh euismod tincidunt ut laoreet dolore magna aliquam erat volutpat.</p> <p> Ut wisi enim ad minim veniam, quis nostrud exerci tation ullamcorper suscipit lobortis nisl ut aliquip</p>	<p> ex ea commodo consequat.</p> <p> Duis autem vel eum iriure dolor in hendrerit in vulputate velit esse molestie consequat, vel illum dolore eu feugiat nulla facilisis at vero eros et accumsan et iusto odio dignissim qui.</p> <p> Blandit praesent luptatum zzril</p>
---	--	---

Figure 9-5.—Side head.

<p><u>Homes receive personal touch</u></p>		
<p><b>Fix it store helps improve quarters</b></p>		
<p> Lorem ipsum dolor sit amet, consectetur adipiscing elit, sed diam nonummy nibh euismod tincidunt ut laoreet dolore magna al-</p>	<p> iquam erat volutpat.</p> <p> Ut wisi enim ad minim veniam, quis nostrud exerci tation ullamcorper suscipit lobortis nisl ut aliquip</p>	<p> ex ea commodo consequat.</p> <p> Duis autem vel eum iriure dolor in hendrerit in vulputate velit esse molestie consequat, vel illum dol-</p>

Figure 9-6.—Kicker.

**SIDE HEAD**

The side head (fig. 9-5) is a headline form that runs alongside a story. It is normally three or four lines and looks best when set flush right. A side head is usually placed slightly above the center of the story.

**KICKER**

The kicker (fig. 9-6) opens up the area on a page where the headline is located. It can be used to introduce a feature article with a pun line above the main head

The following are some basic rules for you to follow when writing kickers:

- Extract kicker information from the bridge or the body of the story.
- Do not repeat words in the kicker and main head. Interpretation of the main head should not depend on information in the kicker.

- Make the kicker 1/2 the point size of the main head. For example, a 36-point main head will have an 18-point kicker.
- Set the kicker 1/3 to 1/2 the width of the main head. For example, a three-column main head requires a one-column to 1 1/2-column kicker.
- Alternate type postures to give the head the proper emphasis. For instance, a roman style main head requires an italic kicker and vice versa.
- Indent the main head two counts (headline unit counting will be explained later) under the kicker, to add white space.
- Always underline the kicker.
- Do not use a kicker at the top of a page.

**HEADLINE VARIANTS**

*LEARNING OBJECTIVE: Recognize the most common variations of standard headlines.*

# Spotlight

Figure 9-7.—Standing head.

## World Series

Continued from Page 21  
consectetur adipiscing elit, sed  
diam nonummy nibh euismod tin-  
cidunt ut laoreet dolore magna al-

iquam erat volutpat.  
Ut wisi enim ad minim veniam,  
quis nostrud exerci tation ullamcor-  
per suscipit lobortis nisl ut aliquip

ex ea commodo consequat.  
Duis autem vel eum iriure dolor  
in hendrerit in vulputate velit esse  
molestie consequat, vel illum dol-

Figure 9-8.—Jump head.

# Champs!

## *Lion matmen capture all-Germany title*

Lorem ipsum dolor sit amet, con-  
sectetur adipiscing elit, sed diam non-  
ummy nibh euismod tincidunt ut laoreet  
dolore magna aliquam erat volutpat.

Ut wisi enim ad minim veniam, quis  
nostrud exerci tation ullamcorper suscipit  
lobortis nisl ut aliquip ex ea commodo  
consequat.

Figure 9-9.—Hammer head.

There are countless variations of headline styles, all of which are viewed in terms of their visual impact when used with basic headline styles. Some of these variants are explained in the following text.

### STANDING HEAD

The standing head (fig. 9-7) is essentially a label used for regular or recurring content, such as sports and chaplains' columns. It does not change from issue to issue.

### JUMP HEAD

The jump head (fig. 9-8) is designed to help the reader find a portion of a story continued from another

page. The jump head uses one or two key words from the headline that introduced the story. It is set flush left followed by the words "Continued from Page ##," usually set in boldface body type (it also can be set in italic). A two-point rule maybe used to extend from the side of the head over the width of the article.

### HAMMER HEAD

Often called a **reverse kicker**, the hammer head (fig. 9-9) is set twice the size of the main head, set flush left and is no wider than half the width of the headline area.

# **Growth:** NAVSTA seeks additional aid for building expansion plan

Lorem ipsum dolor sit amet, consectetur adipiscing elit, sed diam nonummy nibh euismod tin-

cidunt ut laoreet dolore magna aliquam erat volutpat. Ut wisi enim ad minim veniam,

quis nostrud exerci tation ullamcorper suscipit lobortis nisl ut aliquip ex ea commodo consequat.

Figure 9-10.—Tripod head.

# NAVSTA seeks additional aid for building expansion plan

# Growth

Lorem ipsum dolor sit amet, consectetur adipiscing elit, sed diam nonummy nibh euismod tin-

cidunt ut laoreet dolore magna aliquam erat volutpat. Ut wisi enim ad minim veniam,

quis nostrud exerci tation ullamcorper suscipit lobortis nisl ut aliquip ex ea commodo consequat.

Figure 9-11.—Wicket head.

# How C=C=C-Cold Is It...?

Figure 9-12.—Novelty head.

## TRIPOD HEAD

The tripod head (fig. 9-10) is a single, short line of larger type set to the left of two lines of smaller type. The tripod portion (larger wording) should be twice the size of the definition or main headline. For example, a 36-point tripod would dictate that the main head be set in 18-point type to give the true tripod appearance. Punctuation in the form of a colon is required when the tripod conveys a separate thought.

## WICKET HEAD

The wicket head (fig. 9-11) is a tripod in reverse (short line of larger type set to the right of two lines of smaller type). The colon is not used in the wicket. Although it is seldom used, on occasion, you may consider it to vary your newspaper design.

## NOVELTY HEAD

The novelty head (fig. 9-12) features typographical tricks, such as setting part of the head upside down, using an ornate typeface or substituting artwork as characters. Use the novelty headline sparingly with appropriate feature articles. Overuse of this headline may lead to your readership questioning the credibility of the newspaper.

## HEADLINE WRITING SKILLS

*LEARNING OBJECTIVE: Recognize the components and attributes required in headline writing.*



Headline writing requires skill and concentration. Your headline must give the essence of the story. While explaining the story accurately, your headline also must fit into a limited space.

Some copy editors approach headline writing by looking for a key word or two that expresses the high point of the story. Then they add other words until they have a headline. Other copy editors begin by forming a sentence that contains the essential elements of the story. Then they edit out excess words (adverbs, adjectives, articles, and so forth) and minor details until all that is left is a well-tailored headline that tells the story essentials.

Headlines are written in *telegraphic English*, a term coined because they closely resemble the wording found in most telegrams. While the consideration in telegrams is mostly monetary, the economical consideration of headlines is space. Therefore, headlines usually contain — as the “bare bones” of language — a subject and verb. Other strong uses of telegraphic English might include subject-predicate or subject-verb-object constructions.

A straight news headline is written for a straight news story and a feature headline for a feature story. If the story is a colorful account of some event or trip, the headline should be colorful. If the story is a romantic or dramatic account of an event, the headline should follow form. If it is a human interest story with an element of pathos, the headline should not be humorous. If the story is humorous, the headline should not be pathetic.

In the following text, we will cover some of the general principles of headline construction practiced by most copy editors.

## USE OF VERBS

The key to good headline writing is the use, whenever possible, of strong action verbs. Headline writers use verbs in what is sometimes called the “historical present” tense — meaning they use the present tense verb to describe action that has already happened. Primarily, this tense is used to convey a sense of immediacy, in the same way many people normally speak in the present tense to describe exciting experiences to friends. Present tense verbs contain fewer letters than do their past tense forms.

Verbs may be omitted when implied. For example, the verb “appears” is implied in the following headline:

### **Acadia Boatswain’s Mate On ‘Supermarket Sweep’**

However, do not overuse this approach. Action verbs are still best for capturing a reader’s attention. The

verbs is and are are frequently understood. It is not necessary to use them except for clarity. The infinitive “to be” is also awkward in headlines and you should avoid using it. Note the following examples:

- Poor:** New pay raise is approved  
**Better:** New pay raise approved  
**Poor:** Halloween Dance to be held  
Oct. 31 at Fleet Park  
**Better:** Halloween Dance slated  
Oct. 31 at Fleet Park

Do not begin a headline with a verb that might convey the imperative mood (implying a command). Note the examples that follow:

- Poor:** Reject new pay hike  
for armed forces  
**Good:** Armed forces pay hike  
rejected by Congress  
**Better:** Congress rejects  
new pay hike  
for armed forces

To give the reader a better sense of immediacy, the verb should be in the first line of a headline whenever possible. When you can avoid it, do not place the verb in the bottom line of a three-line headline.

## ARTICLES

Omit all articles (a, an, the) and other unnecessary words. Note the following example:

- Poor:** Today’s submariners are “lucky”  
says veteran of the USS *Grant*  
**Better:** Today’s submariners “lucky”  
says USS *Grant* veteran

## VOICE

Use the active voice in preference to the passive voice whenever possible. Note the following examples:

- Poor:** More pilots  
being sought  
for T-45 test  
**Better:** Navy seeks  
more pilots  
for T-45 test  
**Poor:** Navy flight training  
bolstered by new T-45  
**Better:** New T-45s bolster  
Navy flight training

## DECKS

Make each deck (not necessarily each line) a complete construction. Write the headline so it will stand alone and make sense, especially when you use it as the main deck. Consider the following example:

**Poor:** Decade of off-duty study  
cans degree at Memphis

**Better:** Memphis chief earns law degree  
after decade of off-duty study

Because headlines are restricted to a small space, copy editors generally limit headlines to one specific idea expressed forcefully, rather than several ideas expressed vaguely. If space permits, editors sometimes connect two independent thoughts by a semicolon in a headline — or add another section to the headline (a second deck) — to include additional important aspects of the story.

If a story involves a plane crash that kills one crew member, injure the pilot and disrupts a training exercise, you should limit the main deck to the death. Subordinate headlines, or the story, should cover the other news.

## BE SPECIFIC

As with all forms of news writing, the use of specifics is better than generalities. Note the following headline:

Auto crash  
proves fatal

This headline does not contain nearly as much information as the headline that follows:

2 die as car  
smacks tree

## BE POSITIVE

Another custom most headline writers observe is phrasing headlines in a positive, rather than in a negative manner. This is based on the principle that a newspaper is supposed to tell readers what **did** happen, not what **did not** happen.

When writing about a family that escapes injury when their car overturns and bums on a highway, a novice headline writer would probably write the following:

No one hurt  
in car fire

Given the same story, a good headline writer composes the following headline:

Family escapes  
flaming death

## OPINIONS

Headlines on stories dealing with opinion should show the source of that opinion. If a story is attributed to a secondhand source, this should be reflected in the headline. Consider the following examples:

'Courts too lenient'  
claims parish priest

NFL players unhappy  
with owners' offer  
says arbitrator

## REPEATS

You should avoid repeating words in the same headline deck. Also, watch out for similar phraseology in adjacent heads and decks. Consider the following example:

Former *Abraham Lincoln* journalist  
returns to *Abraham Lincoln*  
as public affairs officer

## THE FIVE Ws

A good headline generally has the **who** and the **what** of the story in the first line, with the following lines explaining the **how** and **why**, if necessary.

People expect newspaper stories to concern events that have occurred since the previous edition was published. Therefore, the **when** can usually be omitted. If an event is yet to happen, however, warn the reader by the inclusion of the **when** through the use of the future tense or a specific day or date.

The **where** in a headline on a local story is generally omitted. Readers expect their newspapers to print local stories and will assume a story is local unless the dateline or headline specifies otherwise.

## SHORT SYNONYMS

Use short, vigorous words. Headline writers usually have a vocabulary all their own. They learn to think in terms of short synonyms for longer expressions when writing headlines. Many copy-editing texts contain lists of short synonyms for headline use. Note the following examples:

- **Named** for appointed or elected
- **Set** for arrange or schedule

- **Win** for victory
- **Ex** for former
- **Job** for appointment or position
- **OK** for accept, approve or adopt
- **Try** for attempt
- **Vet** for veteran
- **Hike** for raise or increase
- **Tell** for reveal or inform

In addition to these synonyms, many more are commonly used in Navy newspapers. Some of these are as follows:

- **Sub** for submarine
- **Flyer** or **pilot** for aviator
- **Jet** for jet-propelled aircraft
- **All hands** for entire ship's company
- **Ships** for reenlists
- **Crew** for crew members
- **Plane** for aircraft or airplane
- **XO** for executive officer
- **CO** or **skipper** for commanding officer or captain

## SPLITS

Do not split words, phrases, proper nouns or compound nouns between lines. Note the following examples:

### Words:

5,000 PO1 advance-  
ments predicted off  
September examinations

### Phrases:

Crew members of  
USS Basil Fome  
visit Funafuti

### Proper Names:

Capt. Robert J.  
Matron assumes  
command of HC-16

## Compound Nouns:

Saufley chief petty  
officers sponsor  
orphans' picnic

## LINE BALANCE

Try to balance headlines typographically. Consider the following examples:

### Unbalanced:

Navy, Coast Guard icebreakers  
save U.K. ship

### Balanced:

Navy, Coast Guard icebreakers  
rescue grounded U.K. corvette

## ABBREVIATIONS

You should use commonly known and accepted abbreviations when they are appropriate. Do not be afraid to use Navy abbreviations for ships, aircraft, ratings, ranks, commands, titles, and so forth, in ship and station publications.

The following are some commonly used Navy abbreviations:

**CPO** for chief petty officer

**PO1, P02** and **P03** for petty officer grades

**ComRats** for commuted rations

**NCO** for noncommissioned officer

**LDO** for limited duty officer

**GQ** for general quarters

**SecNav** for Secretary of the Navy

**CNO** for Chief of Naval Operations

Use these and other Navy abbreviations only in ship or station publications. Never use them in press releases to civilian news media. For further information, consult the latest edition of *The Associated Press Stylebook and Libel Manual*.

## PUNCTUATION

Newspaper editors generally adhere to the following style for headlines:

- Use single quotation marks instead of double.

- Use commas to replace the word *and*. Also, where natural, use commas to make pauses or breaks in headline construction.
- Use semicolons to divide thoughts, where needed especially three-line heads.
- Use periods only after abbreviations.
- In a caps and lowercase head, start each line and every important word with capital letters.
- Articles (which are rarely used) and prepositions (which do not lead off a line) are not capitalized in a caps and lowercase head.

**HEADLINE FITTING METHOD**

*LEARNING OBJECTIVE: Summarize the method used to fit headlines properly.*

To make sure a headline fits in its allotted space, you can use a form of measurement called a “unit count.” This system assigns each letter, number, punctuation mark and space character a specified number value. The area on a newspaper page is limited, so it is important that you use the unit count system properly.

**“Flit-j” UNIT COUNT SYSTEM**

Headline counting systems vary from newspaper to newspaper. However, in this section, we use the standard system in the newspaper industry today — the “flit-j” unit count system. The letters that compose the name of this system act as a crutch to remind you what groups of letters receive unique values when counting the headline.

The “flit-j” unit count system is determined by the following rules:

- All lowercase letters and spaces between words or characters each receive one (1) count.

**EXCEPTIONS:** **f, l, i, t** and **j** each receive one-half (0.5) count; **m** and **w** each receive one and one-half (1.5) counts.

- All uppercase letters and all numeric characters each receive one and one-half (1.5) counts.

**EXCEPTIONS:** **M** and **W** each receive two (2) counts; **I** and the numeral **1** each receive one (1) count.

- All punctuation characters each receive one-half (0.5) count.

**EXCEPTIONS:** Each hyphen (-) receives one (1) count; each dollar sign (\$) or question mark (?) receives one and one-half (1.5) counts; each dash (—) receives two (2) counts.

In counting the units in a headline, you place one tick mark over each character or space that has a count of one; place two tick marks over each character that has a count of two; and place one tick mark beneath each character that has a count of one-half.

For example, say you want to count the units in the following headline:

Congress approves \$2 billion year-end budget

First, either write or type the headline on a sheet of paper. Then place the tick marks in pencil, as shown in the following example:

```

//////////////////// //
Congress approves $2 billion year-end budget
/           / / / / /           /

```

After placing the tick marks, total the whole number count values and then add any one-half count values. Note the following example:

```

                22                17
//////////////////// //
Congress approves $2 billion year-end budget
/           / / / / /           /
½                ½ ½ ½ ½ ½ ½                ½
                (4)

```

In this example, the headline count is 43. If the count does not fall within the range of allowed minimum and maximum values for the headline width on the headline schedule, try to change the verb to make it fit. If the headline still does not fit, work with other words in the headline. If you cannot make it fit by changing the other words, begin again with a new headline.

**HEADLINE SCHEDULES**

Maximum unit count limits are predetermined for various newspaper column widths for each headline size of a particular typeface or font. These count limits are provided in charts or lists called headline schedules. A sample headline schedule is shown in figure 9-13.

## HEADLINE CHART

KEY	HEADLINE	COUNT	DESCRIPTION	SIZE
A5	Interim 'O' Club Work Starts	23-26	TEMPO BOLD REG.	60 PT.
B5	Early Separation Set for Some EMs	32-34	TEMPO BOLD REG.	48 PT.
C5	Community Chest Drive Begins Oct. 1	32-35	TEMPO BOLD ITL.	48 PT.
D3	September Production Baseball Team Plans Busy Holiday Card	15-21	SPARTAN ITL.(KICKER)	24 PT.
		18-21	TEMPO BOLD REG.	42 PT.
E3	Interservice Baseball Bluejackets Favored To Win Tournament	15-21	SPARTAN REG.(KICKER)	24 PT.
		17-20	TEMPO BOLD ITL.	42 PT.
F3	10 Tournaments Scheduled	21-24	TEMPO BOLD REG.	36 PT.
G3	From Lake Michigan Shhh! Don't Tell a Soul: NTC Is 'Stealing' Land	15-21	SPARTAN REG.(KICKER)	18 PT.
		20-23	TEMPO BOLD ITL.	36 PT.
H2	Sailor Killed Hitch Hiking On Freeway	10-11½	TEMPO BOLD REG.	48 PT.
I2	SAs Must Be Okayed For E-3 by Wednesday	19-21	TEMPO BOLD REG.	30 PT.
J2	Lost Your Last Friend? Let Locator Help You	20-22	TEMPO BOLD ITL.	30 PT.
K2	4 Honor men from 3 Schools To Receive Certificates Today	23-28	SPARTAN REG.	24 PT.
L1	248 Students in 7 Schools Finish Today	10-12	TEMPO BOLD REG.	36 PT.
M1	Tomasi, O'Neill Lead Carpenters	12-14	TEMPO BOLD REG.	30 PT.
NI	C. Hren Grid Star In Co. 79	7-9	TEMPO BOLD ITL.	30 PT.
O1	Wave Softball Nine Schedules Kenneth Girls	12-14	SPARTAN REG.	24 PT.
PI	Caprin Wilda Sends Greeting	11-14	SPARTAN ITL.	24 PT.

Figure 9-13.—Sample headline schedule.

The chart gives the minimum-maximum unit count for each line based on the number of columns the line stretches across. Each headline listed on the chart is often given a key, or code, that tells the printer the name of the type style and the number of columns the headline covers. As shown in figure 9-4, a headline with a key "A5" would indicate a headline set in a 60-point type style called Tempo Bold Reg., which has a minimum-maximum unit count of 23-26 stretched across five columns (the number indicated in the "AS" key).

### CUTLINES

*LEARNING OBJECTIVE: Detail the methods used in gathering material for cutlines and identify cutline components, typography, layout and datelines.*

Photographs have a unique storytelling ability. They are most effective when accompanied by some explanatory text.

A missile launching may make an exciting photograph, but it fails as a news vehicle unless the reader understands the **when**, **where** and **why** of the photograph, as well as the more obvious **what** and **how**.

The function of providing information the photograph does not furnish is performed by the photograph's cutline, also known as a photo caption. A cutline supplements the photograph by explaining action, naming people and giving background information.

The cutline writer is normally a middleman, who takes a photograph (which is inflexible) and adds the cutline (which is flexible) and comes out with a story. The cutline writer determines what additional information must be given to communicate the story the photograph is meant to tell.

Cutline writing is a specialized form of news-writing. It answers the same basic questions as the news story. Yet, it does this in a single, concise paragraph. The cutline writer must be alert to answer any questions the photograph may arouse in the reader's mind.



## GATHERING OUTLINE INFORMATION

There is no secret formula to gathering outline information. However, there are certain practices you should follow that will allow you to write effective outlines after you return to your office. These practices are covered in the following text.

### How to Record Outline Information

Cutline information maybe recorded in a notebook or a locally designed “caption log.” A caption log may serve as a handy reminder of what information you should record. An example of a locally designed caption log is shown in figure 9-14.

### What Outline Material Is Recorded

When you gather material for cutlines, you generally use the same methods and techniques as for gathering information for a news story. The major difference is that you do not need as much information, but it must be pertinent to the scene in the photograph.

The following are a few points to consider before you write a cutline:

- What is the storytelling value of the photograph?
- Is the photograph intended for internal or external use? (Photographs for civilians may need more information.)
- Will the photograph be released to a hometown paper? If so, you must include a hometown tie-in.
- Will the photograph be used alone or with a story?

With these basic considerations in mind, try to stick with the old but reliable five Ws (and H) when you gather cutline material. Find the answers to the most pertinent questions, and you will have more than enough information to write your cutline.

**WHO.**— Identify people in the photograph by rank full name, title, hometown, and so forth. Also note relative positions of people in the photograph when there are more than one and if it is not obvious who is who by action, age, gender or rank. Sometimes it is helpful for you to note the clothing or physical characteristics of the people being photographed. Keep in mind that when you or your photographer use black-and-white film, it will do little good to note “yellow T-shirt” or “red dress” on the caption log.

However, such notations as “Mets T-shirt,” “sunglasses” or “curly blond hair” will prove helpful.

**WHAT.**— The “what” can apply to two areas. First, it may involve what is happening in the photograph. In the caption log, it maybe necessary to jot down a word or two to describe the action. For example, “slicing cake,” “performing PMS check” or “donning EEBD.”

Second, the “what” may entail equipment in the photograph. Unusual equipment often is included in photographs. The equipment should be identified. An OBA may not require identification, but an OBA with a lifeline attached may need further elaboration. Ships and aircraft should always be identified. Never guess or suppose you know the proper nomenclature; ask an expert on the scene.

**WHERE.**— Make sure you record the location of the action. Write down the name or number of street names, building names or numbers, and so forth. If there are landmarks, either natural or man-made, identify them as well. These might include rivers, lakes, statues, bridges and mountains.

**WHEN.**— Record the time and date the photograph was taken. This is especially important for “wild” or “stand-alone” photographs that will not be accompanied by a story.

**WHY.**— Unless it is obvious, record why an action is taking place. Is it part of a base basketball championship or a monthly awards ceremony? As in the “when” category, this is important for photographs that will stand by themselves.

**HOW.**— If there are circumstances that led to the photograph being taken and they require explanation, make sure you know how they came about.

### Matching Outline Information with the Photograph

You should record cutline information by individual frame number. However, if you shoot several frames of the same subject and action, it is not necessary for you to record information each time. Simply list the range of frame numbers in which the subject appeared.

### When to Record Outline Information

Record the cutline information immediately after each shot or series of shots. Do not let subjects getaway without jotting down the required cutline information. They may be hard or impossible to track down later, and

you may forget who you shot or who was doing what in the photograph.

One exception to this practice is a sporting event where it is impossible to interrupt the action. In this instance, let the subject(s) know in advance that you will be taking photographs and will need to get identification as soon as possible after the event. Note uniform numbers, clothing or physical characteristics. You also may record the information during breaks in the action.

## CUTLINE COMPONENTS

We will not go into detail here on how your photographs should be posed and what to look for in the way of composition. This will be covered in Chapter 12, *Basic Photojournalism*. The primary concern now is the text that accompanies the photograph and how it should be written. Although newswriting and cutline writing are closely related, they are different.

The lead in a news story is the most important part of the story. The facts presented in the lead may be expanded and elaborated on in the bridge and body of the story.

The cutline differs in that it is more than a part of the story — it is the **whole** story. Everything you have to say about the photograph is said in one paragraph. That paragraph must contain the essential facts, and the facts must be tied into the scene in the photograph. The length of a cutline is always governed by what must be told about the photograph. It may consist of one word, one sentence, or it may consist of five sentences.

Cutlines have no set lengths. Strive for simplicity and brevity. The shorter you can write a cutline and still include all the essential information, the better it will be.

As in headline writing, a cutline is written in a manner appropriate to the subject matter. In other words, write a news cutline for a news photograph and a feature cutline for a feature type of photograph.

There are probably as many ways to write cutlines as there are newspapers, magazines and other periodicals. Just about every publication has its own individual requirements and style of cutline writing. Some want long cutlines. Some want only one or two words to tease a reader into reading the accompanying story. Others use no cutline at all.

Only one method of cutline writing will be covered in this chapter. It is considered the handiest formula for a novice writer and consists of the following four major components:

- The action
- The identification (persons or things in the photograph)
- The background information
- The credit line

### The Action

The first sentence of a cutline is the most important. It must link with the photograph by describing its action.

One of the peculiarities of the first sentence is its verb form. The verb in the first sentence of a cutline is in the present tense. The reason for this is that photographs, like paintings and sculpture, capture one moment of time and keep it in the present.

Another reason for using the present tense in the first sentence is that it gives the readers a sense of immediacy, as though they were actually witnessing the event shown. Thus a cutline that reads, “Navy Seaman Jack Crevalle **swims** through swirling flood waters of the Baylinguay River to rescue 6-year-old Tia Maria...” has more dramatic impact than one that reads, “Navy Seaman Jack Crevalle **swam** through. . .”

One problem that arises from the use of the present tense in the first sentence is what to do with the **when** element. To put the time element in the first sentence would result in a sentence such as “Ryan Thompson hits a line drive to center field yesterday. . .” This is somewhat jarring to the reader and should be avoided.

To alleviate this problem, you can usually reserve the time element in cutlines for the second sentence. This avoids awkward sentences such as the one just quoted.

### The Identification

The second part of a cutline is the identification. This includes an identification of all persons and things vital to the storytelling function of the photograph. Everyone who is involved in the central action of the photograph should be identified. Do not identify persons who are blurred out, obscured or too far away for recognition. Anyone in a photograph who attracts the reader’s attention should be identified. The reader’s curiosity should never be impeded. If the identity of a pertinent figure in a photograph is unknown, make this fact a part of the cutline.

The next question concerning identification, is where should it be placed in the cutline? The best answer



is, it should come as high as possible in the paragraph. Many times it will be possible to identify people at the same time the action is described. For example, in the statement "Seaman Apprentice Jay B. McMannus sounds taps to climax Memorial Day ceremonies . . ." the identification is included as the subject of the action. Sometimes, however, it may be preferable to use an impersonal identification (such as "A Navy musician sounds . . .") in the first sentence. In that case, the complete identification should come in the second sentence.

The only exception to the ground rule previously stated is in the case of group identification. When there are several people to be identified in a photograph, it is better that you not clutter the first two sentences with a list of names. This is apt to discourage the reader from finishing the cutline. The recommended way to handle a group photograph is that you use an impersonal identification in the first sentence (such as, "A group of sailors . . ."), then list the names later in the cutline. This achieves complete identification without cluttering the important first sentence.

The identification itself can be handled in one of several ways. The idea is to handle it in the most natural and concise manner consistent with clarity. The best way to identify people is by action. If Kip Karuthers is throwing a pass to Ronnie Gate, it should be obvious from the photograph which one is passing and which one is receiving the ball. Thus they are identified by their activity, and you will not have to use left and right identifications.

Another simple manner of identifying people in a photograph is by obvious contrast. If there are two sailors and an officer in a photograph, it is not necessary to identify the officer as being to the left, or in the center. The officer is well-identified by obvious contrast, therefore, place identification would be superfluous.

Identification by elimination is slightly more complex. Suppose there are four people in a photograph. One of them is receiving a medal from another. These two are identified by the action. A third person is the award recipient's wife. She is identified by obvious contrast. Therefore, the fourth person is identified by elimination.

For example, the identification in the cutline might be handled in the following manner:

"Lt. Wayne E. Pilot receives the Distinguished Flying Cross from his squadron leader, Cmdr. William A. Aviator. Lt. Pilot's wife, Gertrude, and Lt. Cmdr. Thomas V. Hoek, VAP-99 XO, look on."

Finally, there is the traditional left, right, center or "from the left" identification. It is not necessary to say "from left to right." This wastes space. If one starts from the left, there is no place to go but right! Use this type of identification only when the other means of identification will not suffice or when there is a chance of the reader becoming confused.

In cutline identification, avoid bromides, such as "pictured above" or "shown above." It is apparent to both the editor and the reader that something is pictured or shown above the cutline. Even worse are such phrases as "posing for this picture are . . ." or "smiling for the camera is . . ."

## **The Background Information**

The third component of the cutline is the background information. This consists of additional facts or explanations needed to clarify the subject matter of the photograph. The length of this section of the cutline depends on two factors mentioned earlier: (1) where the photograph will be used and (2) how the photograph will be used.

The amount of background information needed to explain a photograph of carrier operations to a civilian reader will obviously be greater than that needed to explain it to crew members who are participating in such operations.

If a photograph is to accompany a news story, do not duplicate details used in the story. If the photograph is to be used alone, the cutline must be complete.

Cutlines prepared for picture stories are similar to those written for single photographs, except that a story is told by means of a series of related photographs. In this case, a main cutline, usually written for the lead or key photograph of the story, can supply background information for the entire story.

Although present tense is used to describe the action, the correct past, present or future tense is used when presenting background facts related to the action. However, you should be careful of changing tenses in the middle of a sentence.

## **The Credit Line**

The last component of the cutline is the credit line. Most ship and station newspapers use credit lines for photographs.

## CUTLINE TYPOGRAPHY

If you are writing cutlines for external release, do not concern yourself with the way the cutline will be set in type. However, if you edit a ship or station newspaper, you will need some knowledge of cutline typography.

Good cutline typography heightens the impact of a photograph by making the explanatory text as visually appealing as possible. It is a good idea to rewrite and reset Navy Editor Service (NES) cutlines, because they may violate your local style, and the typefaces used may not match yours.

For better display, cutlines are usually set in a larger or a different typeface than that used in the news columns. Some papers use the same size and style as their body type, except that it is set boldface.

Cutlines under multicolumn photographs are best displayed when set two columns wide for two-column photographs (fig. 9-15) or a column-and-a-half wrapped for three-column photographs (fig. 9-16). The term *wrapped* means to place two or more columns of type side by side under one heading or piece of art. Cutlines should not be set wider than two columns.

### Captions

The word *caption*, while often used as a synonym for the word *cutline*, has a second meaning. It is a small headline, or display line, sometimes used with cutlines.

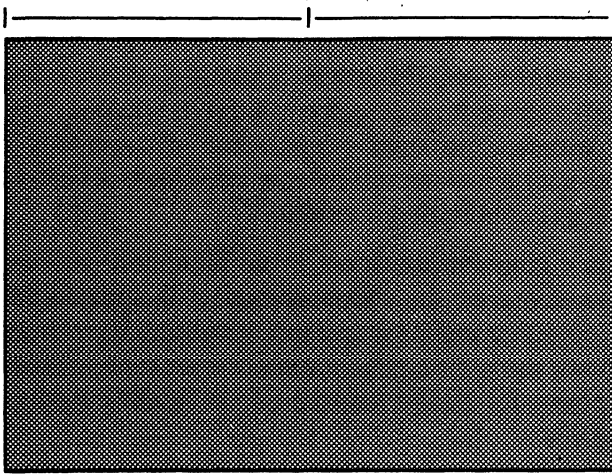

This Picture Shows for man...  
Woman...  
Government...

Figure 9-15.—Cutline set two columns wide.

There are several ways of crediting photographs. Some newspapers and magazines give photographers personal credit lines (this is encouraged for ship and station newspapers). Others use a blanket statement which states, for instance, that “all photos are U.S. Navy photos unless otherwise credited.” However, the recommended way is to put the credit line at the end of the cutline itself. The credit line should follow the last word of the cutline, in parentheses in the following manner: (U.S. Navy Photo by JO3 Evelyn Grudge) or (U.S. Navy Photo).

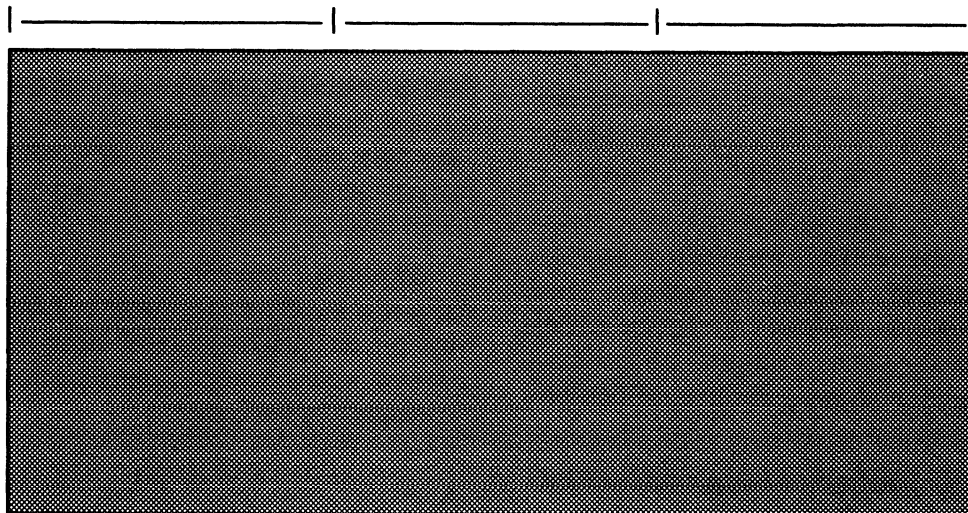

This Picture was taken...  
K...  
S...  
P...

Figure 9-16.—Cutline for a three-column photograph set a column and a half wide.

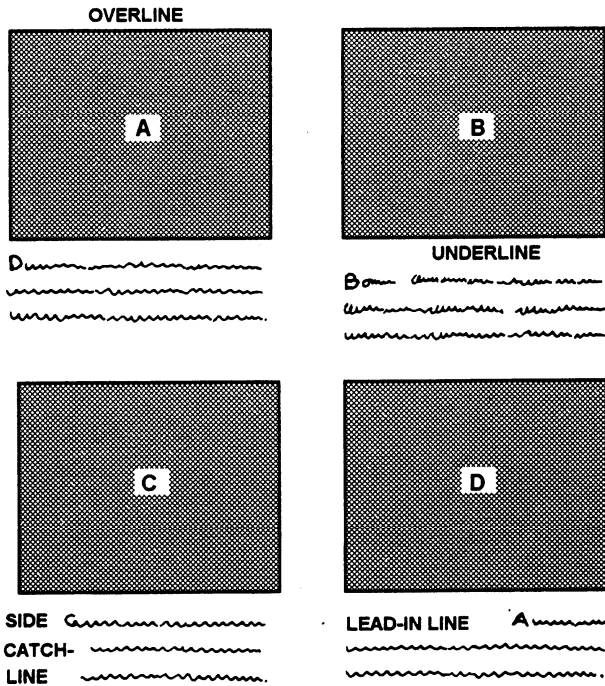

Figure 9-17.—The four basic caption forms: (A) overline (B) underline, (C) side catchline and (D) lead-in line.

Its function is essentially the same as those used over a news story as follows:

- To summarize
- To attract attention
- To dress up the page

There are several kinds of captions in this context. An **overline** runs above the photograph. An **underline** runs between the photograph and the cutline. The **side catchline** is used with photographs of three columns or more and runs on the left side of the cutline. If a headline is not used, the first few words of the cutline maybe set in boldface or all capital letters to serve as a **lead-in line**. These four types of captions are shown in figure 9-17. All such display lines should be in large type, preferably the kind used in a small headline.

### Mortised Photographs

Photographs that contain dead areas of sky or unimportant background can be mortised (a rectangular window, or space, is cut out and the cutline is placed in the space). This saves page space and may actually improve the photograph.

## CUTLINE LAYOUT

When laying out a page, you should treat each photograph and its cutline as one unit. The relationship of photograph to cutline must be obvious. Readers will seldom spend much time hunting for misplaced cutlines. In addition, cutlines may be run beside or above photographs. This adds variety, and in some cases, enhances page layout.

It is a common practice for most newspapers to run the story and accompanying photographs side by side. Because of space limitations, however, this is impractical at times. If a story and an accompanying photograph must be separated in a newspaper for any reason, the two are still “keyed” together. For example, if the photograph appears on page one and the story on page four, the cutline will carry a line that says “Story on page 4.” This keys the two together for the reader’s convenience.

There are times when a newspaper may not have space to publish both story and photograph. When this happens, one or the other will be discarded. If it is the story that gets the toss, the cutline must be rewritten to include more details.

When a photograph and cutline are released with a story or when you are writing a story and cutline for your command’s newspaper, the best practice is to write the story first. After the story is written, write the cutline for the photograph. There are two important reasons for this — (1) it enables you to avoid any duplication of phrases or ideas that appear in the story and (2) it enables you to write tighter, more compact cutlines. After writing the story, you have the salient features clear in your mind, and the act of paring the cutline down to its essentials becomes much easier.

## DATELINES

When preparing cutlines for photographs to be released externally, you need not concern yourself with display lines. You merely write your cutline in complete and simple sentence form. An additional component must accompany a cutline for outside release — the dateline.

The dateline answers the question “where?” and is used as a lead-in to the cutline. For example, a datelined cutline might read: “ABOARD THE USS UNITED STATES AT SEA — Carrier pilots leave . . .”

Additional information on datelines maybe found in *The Associated Press Stylebook and Libel Manual*.



## CHAPTER 10

# LIBEL, RIGHT OF PRIVACY, FREEDOM OF INFORMATION AND COPYRIGHT

Is the First Amendment of the U.S. Constitution the same to a reporter as an umpire's "call 'em as I see 'em" license? Is the new city official really a crafty, communist sympathizer?

To the grief of many a publisher and reporter, there is no absolute license to print whatever one pleases about a private citizen or about the government.

Free speech and free press, as guaranteed by the Constitution, have two sides: on one side, the right to use them; on the other, the duty not to abuse them. When the news media abuses its right to a free press, they commit an age-old offense known as libel — the defamation of a person's reputation.

Because your job is to write about the Navy, you should become acquainted with the danger of defamation. This chapter provides information on what you should guard against when releasing material to the news media or publishing it in internal publications. It also acquaints you with the right of privacy and some of the laws of copyright.

### LIBEL AND SLANDER

*LEARNING OBJECTIVE: Define libel and slander; identify how libel is committed and determine who is responsible for a libelous story.*

Libel is a difficult offense to describe. Libel laws are state laws, and there are differences in the definitions of libel from state to state. For the purposes of this training manual, we will define libel as follows:

*Libel is a published (written, printed or pictured) defamation that unjustly holds a person up to ridicule, contempt, hatred or financial injury.*

All states agree that libel is a **defamation**, an act that tends to degrade or lower a person in the eyes of others. The effects can subject a person to ridicule, hatred or contempt (or all three), or they can cause a person financial injury by hurting the person's property or business or by causing loss of employment.

As you can see, defamation does not have to be sensational to be libelous. A picture with the people erroneously identified in the caption can be libelous. A newspaper headline, even if the story under it is blameless, can be libelous.

Radio and television are not exempt from libel laws. A picture on television can be as libelous as one printed in a newspaper. A radio broadcast can defame an individual, although there is some dispute in the courts as to whether the offense would be libel or slander. Slander differs from libel chiefly in that it is spoken instead of printed, written or pictured. In other words, slander is defamation by oral communication. A major distinction between libel and slander is found in the word "published." Since slander is an oral defamation, the courts tend to view it as a lesser offense than libel because the words, once uttered, are quickly gone. Libel, on the other hand, is a published wrong and is felt to endure longer and thus cause greater injury. Consequently, the law is much stricter in dealing with libel cases than with slander claims.

However, the subject becomes a bit cloudy when oral remarks (slander) are read from a written script or when they are recorded. Therefore, you should exercise equal care to avoid both oral and written defamatory statements.

True statements about a person also can be libelous. Many people think that libel results only from untruths told about another. This is not so. The truth can sometimes defame an individual as much as a lie.

A simple defamation, however, is not always libel. The following are three conditions that are necessary before a statement becomes libel:

- There must be a **true defamation**. In other words, a person's character or property must in some way be degraded.
- There must be **clear identification** of the person. This identification, however, does not have to be by name. A writer (or an artist) can very easily leave no doubt in the public's mind as to a person's identity without mentioning the individual's name. Even if only a few persons

were to realize the person's identity, libel is still possible.

- The libel must be published. This does not mean that it must be printed in a newspaper. You will recall from the definition that libel can be written (as in a letter that is seen by a single third person) or it can be pictured (as in a photograph or cartoon). Spoken libel, or slander, is also considered by the courts to have been published. As a Navy journalist, you will not have to concern yourself too much about the legal and technical differences between libel and slander. It is sufficient to know that any defamation may be considered unlawful, regardless of whether it is written or spoken. One of your jobs is to make sure that defamatory statements do not reach print or the airwaves through a Navy news release.

Libel, as an offense, is almost as old as civilization. Many early societies punished those who would harm the name or reputation of another. Decimation before the invention of printing almost always took the form of slander. An early code of Egyptian law recognized slander as an offense against the sun god.

After the invention of printing, libel became very closely related to freedom of the press. Through history, governments have taken various and often harsh views of a free press. For centuries, the struggle for some measure of press freedom was an uphill battle. Much of the trouble encountered in striving for press freedom revolved around the fact that for a long time governments considered any adverse criticism or comment to be libelous. Thus rulers went as far as to imprison or put to death writers who had criticized them in print. Even today, in some countries, too much of the wrong kind of criticism can mean a newspaper will be closed.

A balance between ruthless suppression and license was struck by the U.S. Constitution, and the courts have strengthened this balance in the intervening years. Today, as one writer says, freedom of the press and speech is "the first principle of the Anglo-American legal structure." He goes on to say these freedoms are a "specific legal principle defining the relationship, in a democracy, between the people and their elected representatives."

Libel laws exist because the free press is a two-way street. There are obligations that accompany the rights of freedom of speech and press. The managers of a respectable news medium obey the libel laws not merely

because they wish to avoid being sued but because they believe in the dignity of the individual.

## **HOW LIBEL IS COMMITTED**

If news media commit libel today, it generally occurs in one or more of the following areas:

- Attacking a person's character or personal reputation
- Accusing someone of a loathsome disease or insanity
- Accusing someone of a crime
- Attacking a person's professional competence
- Subjecting a person, in any way, to public contempt, hatred or ridicule

Instances of libel are more common than most people suspect, and court action does not have to result before a statement becomes libelous. There are hundreds of instances of libel everyday in the United States news media. The vast majority of them are minor or borderline cases, and most of the more serious ones go unnoticed or uncontested. There are relatively few court actions for libel.

## **RESPONSIBILITY FOR LIBEL**

Let's assume that you write a story and accidentally include a statement that offends somebody. The person offended sues for libel. Who is responsible? Who pays? A casual observer might think that in a suit against a large newspaper, any damages will be paid by the medium publishing the story. This is not necessarily so.

Technically, everybody who had anything to do with the statement may be sued. This includes you, the PAO who released it, the officer in command who is responsible for everything you release, the editor who accepted it, the editor who approved it and anybody else in the chain of events who read it, understood it, yet allowed the statement to reach print.

Another point worth emphasizing is that any person who reprints a libelous statement can be held as being just as guilty as the person who originally published it. For example, assume that one newspaper publishes a libelous statement. Another newspaper picks up the story, credits the first newspaper with the facts and republishes it. The second newspaper may be just as guilty as the first, if the case reaches court and libel is proved. In some states, charges may be brought against both newspapers.

Wire services are similarly liable. Occasionally, a newspaper will publish a wire service story that is libelous and the newspaper cannot or does not verify the facts in the story. Despite the circumstances, some states hold that the newspaper is just as responsible as the wire service, while other states place the blame solely on the wire service. Nevertheless, a person can name anyone in a lawsuit who had anything to do with the preparation of the story or its distribution.

## TYPES OF LIBEL

*LEARNING OBJECTIVE: Identify the different types of libel.*

There are two kinds of libel — obvious libel and libel by inference (hidden libel), referred to in law as **libel per se** and **libel per quod**, respectively. Do not let yourself become confused by the Latin terms.

### LIBEL PER SE

The more obvious of the two, libel per se, means “by itself” or “on the face of it.” The reader or viewer does not have to interpret or study in order to understand the libel per se because it is obvious or evident. Libel per se is the more serious of the two types, and persons libeled in this manner do not have to prove that they suffered damage to their reputations, monetary loss or other injury. Libel per se can support a lawsuit in itself.

There are probably thousands of words, phrases and statements in the English language that are libelous in themselves. Some of them are of a political nature, others refer to race or religion and still others involve specific professions and occupations. Others (and this is no doubt the largest group) affect the honesty, integrity or morals of anyone to whom they are applied.

Here are just a few examples of words and phrases you should **not** use in reference to individuals or groups:

- **Professionals.** Attorney: shyster, ambulance chaser, crafty, unprincipled, and slick Business person: swindler, racketeer, double-dealer, cheat, and phony. Politician: liar, grafter, perjurer, seller of influence, pocketeer of public funds, and criminal’s partner. Doctor: quack abortionist, faker, and incompetent. Also, never use such words as crooked and criminal to describe people or their behavior.

- **Affiliations.** Red, Communist, Nazi, a member of the Ku Klux Klan, atheist, nudist and socialist (sometimes).
- **Honesty and Morals.** Unreliable, a credit risk, hypocrite, adulterer, unchaste, prostitute, drunkard, conspirator, mistress and thief.

Obviously, there can be many more classifications of words and phrases that are libelous in themselves. For example, a word like “drunkard” can have numerous synonyms, all just as libelous, and the same thing applies to most of the nouns and adjectives in the preceding list.

Another point worth considering is that the meanings of words and phrases can and do change. Over a period of years the meaning of a word or phrase can shift gradually until it is no longer libelous in itself or libelous at all. The reverse also is true. A word or phrase harmless a few years ago maybe libelous in itself today.

A word that has almost entirely lost a previous libelous per se meaning is “alcoholic.” A few years ago the word was synonymous with “drunkard,” but today it refers to an illness — alcoholism. Words of this type, however, should still be used with caution.

As for a word’s meaning changing from a safe description to a libelous one, do you remember when “gay” meant happy and carefree?

In a libel suit, if the defamatory material is libelous in itself, the court decides on the interpretation of the words and phrases involved; the news medium does not. If the court decides the material can be understood as libelous by the public, the publisher involved has no argument.

### LIBEL PER QUOD

The second type of libel is committed by inference and is more “hidden.” Its legal term, libel per quod, means “because of circumstance” or “by means of circumstance.” In libel per quod, the statements, words or phrases involved maybe harmless in themselves, but become libelous because of attached circumstances. Usually, such circumstances are unforeseen by the publisher, who can claim that the questionable material was published in good faith and without malice. However, good faith is not a complete defense.

Here is a classic example of libel by circumstance: A news story reported an athlete’s spectacular feats on the tennis court the previous Saturday. In fact, the tennis match was on Friday, not Saturday; a simple error. However, the story was libelous per quod because the

athlete in question belonged to a religion that observes Saturday as the Sabbath — a day of quiet and meditation. The story, as it was printed, defamed the athlete as not being a devout member of his church.

Libel per quod is the most common of all libels. Very few publishers intentionally undertake the risk involved in printing material that is obviously libelous. However, libel per quod often occurs because of errors or negligence. There are countless other examples of libel by circumstances — wrong names, wrong addresses, and so forth.

Libel by circumstances also may result from what the reader may infer. In a story appearing in a national magazine, a man was described as being a legislative representative (lobbyist) for the Communist Party. The man charged in a suit that this statement damaged his reputation because it implied he was a communist sympathizer. Whether the man was, or was not, a communist sympathizer or a lobbyist for the party was beside the point. The man claimed he had been defamed, and his claim was upheld by a federal appeals court.

“Guilt by association” also is a form of libel per quod. This form of libel, sad to say, has been employed for many years by unscrupulous politicians and others seeking positions of power.

Perhaps the most obvious use of this method has been the linking of various persons to the Communist Party by innuendo. During a political campaign in the west several years ago, pamphlets appeared describing a U.S. senator who was running for re-election, as being friendly toward communist aims. One of the principal items of evidence given to support this claim was the fact that the senator had participated in a pre-World War II meeting during which Russia and Stalin were praised as foes of Nazi Germany. The pamphlets were clearly an example of circumstantial libel — what the reader might infer. The intent of the writers of the pamphlet was apparently to damage the senator’s reputation in order to injure his election prospects.

## **LIBEL AND THE LAW**

*LEARNING OBJECTIVE: Recognize the laws that apply to civil and criminal libel and the defenses against libel action.*

We have pointed out that the laws of libel are state laws, unlike the U.S. Constitution or other national laws that bind **all** U.S. citizens. Libel laws vary from state to state with each state free to make changes in its libel code whenever it chooses. As a result, there is little

uniformity among the states regarding award of damages or the nature of judgments in similar types of libel cases.

The state laws of libel are complex and can be understood thoroughly only by an attorney or a person trained in this field. In this section of the chapter, we only describe some of the “ground rules” that generally apply in all states.

There are two types of legal action that can result from publication of libelous material: **civil action** and **criminal action**.

### **CIVIL LIBEL ACTION**

Civil libel action results when one person sues another in court because of alleged defamation. This defamation, again, need not be to the individual’s character or reputation. It can be to a person’s business, occupation or property.

Civil libel also can be committed against a legal “person” composed of more than one individual. In this regard, a corporation, a partnership or any other association of individuals can be defamed. General Motors could sue an individual for defaming its products or business practices. Also, an individual could sue General Motors. One corporation also can sue another corporation.

Individuals cannot sue the U.S. government, however, unless it consents to the suit. When people feel they have been libeled by an agency of the government, they still cannot bring suit unless the government agrees to be sued.

Civil libel suits are always between persons, whether the “person” is an individual, an association of individuals or an artificial being, such as a corporation. A sum of money is the usual compensation awarded by civil courts for damages. The amount has varied from one cent, a nominal sum to indicate vindication, to millions of dollars.

Money awarded in libel cases is intended to compensate the injured party for mental or physical suffering and for actual financial loss and to punish the individual or individuals who committed the libel.

### **CRIMINAL LIBEL ACTION**

Criminal libel action is less common than civil libel action, but it is much more serious. Criminal libel is a crime and can be prosecuted in the courts like any other crime. In criminal libel the state is the accuser and the



punisher. Persons convicted of criminal libel can be fined, imprisoned or both, depending on the gravity of the offense.

Any libel that tends to disturb public peace and order can be a criminal offense. For instance, if a popular public figure were to be libeled to the extent that riots resulted, the libel would be of a criminal nature. Obscene libel can be a criminal offense because it is considered to have an ill effect on public morals.

One of the most grave types of criminal libel is seditious libel — that which defames an established government, or one of its agents, in an attempt to thwart or overthrow it. Criminal libel, if directed at the U.S. government, becomes a federal offense and can result in a long prison term for the libeler. Seditious libel is rare, but it has occurred in cases when news organizations or individuals have written violent defamations of the government in their opposition to federal laws or the decrees of federal courts. Mere opposition to a court decree is not necessarily libelous (though it could be seditious). Remember, there is no libel involved until there is defamation.

## **DEFENSES AGAINST LIBEL ACTION**

An individual, a newspaper or other news organization is not without some degree of protection when being sued for libel. In the following text, we cover some of the partial and complete defense strategies that might lessen the damages assessed against a defendant in a libel suit.

### **Partial Defenses**

There are eight basic partial defenses against libel action, as covered in the following text.

**INNOCENT MISTAKE/ACCIDENT.**— The first mitigating factor to consider is innocent mistake, or accident, which appears in the libel codes of most states. Almost self-explanatory, it means that a defendant can be excused partially if it can be proved the libelous material was published unintentionally or without the publisher realizing it was defamatory. The “innocent mistake” law does not remove liability, but it may reduce it.

**RETRACTION, APOLOGY OR CORRECTION.**— A retraction, apology or correction, usually printed with the same prominence as the original libelous material, will sometimes satisfy a person who claims to have been libeled. Nevertheless, the libeled party still retains the right to bring suit. Although

retractions, apologies and corrections are three separate (partial) defenses, they are related and often overlap. A retraction is often accompanied by a correction when it is employed, and both, almost always, are accompanied by an apology. One disadvantage of a retraction, or apology, is that it puts the original defamatory remark before the public eye again, although hopefully, in a much nicer form.

An example to the contrary is this story about a southern editor of a few years ago: The editor was bitterly opposed by certain people in the town and did not hesitate to become quite harsh on them in print. One man insisted he had been libeled and demanded a retraction. The next issue of the paper appeared with the following line in large type:

### **JOHN GREEN IS NOT A BRAYING ASS**

In that example the editor successfully and wittily continued his feud; but regrettably, he also compounded the original libel.

**REPETITION.**— The defense of repetition can be used when a newspaper uses a libelous story that has been printed elsewhere, in a wire service article for example. In a number of recent court decisions, newspapers were not held responsible for libels committed by wire services, since it was recognized that editors could not possibly check out every story received from those sources.

**LACK OF MALICE.**— In the lack of malice defense, punitive damages are usually not awarded if the publisher can demonstrate good faith and justifiable ends.

**SELF-DEFENSE/REPLY.**— A self-defense or reply defense can sometimes be successful if the publisher can show that the libel was a response to a previous attack made by the person claiming libel.

**UNCONTRADICTED RUMOR.**— The uncontradicted rumor defense can sometimes serve to lessen the damages that could be awarded in a libel case if the publisher can show that the libel was merely a published version of widely circulated rumors that the plaintiff had made no effort to deny.

**USE OF AUTHORITY.**— In employing the use of authority defense, a publisher would try to show that the libel originated from a source that could reasonably be expected to be accurate. A successful presentation of this defense, while not exonerating the publisher, could serve to lessen the damages awarded.

**PRIOR BAD REPUTATION.**— A prior bad reputation defense might prove useful to a publisher accused of libel if it could be shown that the plaintiff already had an unsavory standing in the community and the defamatory statement caused very little additional injury.

Keep in mind that these partial defenses are just that — partial. They may lessen punitive damages, or in some cases eliminate them, but they do not excuse the libel charge.

### **Complete Defenses**

The seven complete defenses against libel charges can absolve the publisher of all liabilities if successfully used. Incidentally, it is important for you to note that in libel cases, unlike other cases tried in our country's judicial system, the burden of proof is on the accused, not on the plaintiff or the prosecution.

**TRUTH.**— Truth is the best complete defense against libel action. Some state laws read that truth alone will suffice as a defense in a civil libel suit; others maintain that the truth must be “without malice.” In either case, the facts published must be provably true.

If the law requires “truth without malice,” the defendant also must prove good intentions. Malice, however, as judged by the courts today, does not mean only “intent to harm.” The consensus appears to be that “truth without malice” must be “truth for a good reason.” The good reason is usually judged by determining if the material presented is in the best interest or concern of the public.

For example, a newspaper prints a story about a man running for a high public office and states that the candidate has served a prison term for embezzlement. The statement is true, and the newspaper's reason for printing it is the belief in the public's right to know, or the “public good.” The candidate's history, in this instance, would give reasonable doubt of his qualifications for public office.

If, however, the same statement had been made about a private citizen who was in no way connected with the public welfare, there would have been no “good reason” for publishing that information.

**FAIR COMMENT AND CRITICISM.**— A publisher can claim the fair comment and criticism defense in many instances. The courts are often lenient when fair comment or criticism is made of a political organization or any powerful corporation; in reviews of television programs, movies, plays and books; or in

articles dealing with officials or agencies of the U.S. government. It has been established that one of the chief functions of the news media is to serve as a critic of the wielders of public or private power. The courts reason that this function should not be arbitrarily suppressed.

Many newspapers engage in “crusades” against a dishonest or bungling government and against crooked gambling or other criminal activities. As long as a newspaper approaches such a “crusade” in a responsible manner, it is well within its rights. Every year Pulitzer Prizes are given to individual reporters for either having exposed private or public abuses of power, and in some cases, having caused their confessions.

**PRIVILEGE.**— Privilege, as a defense against libel, deals with legislative and judicial operations. There are two kinds of privilege. One is “absolute privilege”; the other is “qualified privilege.”

**Absolute Privilege.**— Absolute privilege protects those directly involved in judicial proceedings (judges, attorneys and witnesses) and legislative matters (the President, governors, mayors and lawmakers at the federal, state, county and city levels). Absolute privilege does not apply to the news media.

**Qualified Privilege.**— Qualified privilege does apply to the news media and affords them qualified, or conditional, protection in reporting public and official proceedings. The conditions for this protection are that a story must be characterized as follows:

1. Fair, accurate and complete
2. Without malice
3. Published for justifiable ends

The one limitation of qualified privilege is that a story must not include any obscenity. Other than that, legislative and judicial proceedings may be reported in their entirety, regardless of the truth or falseness of what is said. The legal theory supporting this license holds that the public interest in public matters should be served, even at the expense of individual defamation.

Remember, however, that this privilege does not cover the reporting of conventions of private organizations, such as political parties, labor unions and churches.

**LACK OF PUBLICATION.**— Lack of publication as a complete defense is more likely to be used in a libel case involving some form of personal communication that may or may not have been seen by a single third party. This defense could hardly serve the

needs of a newspaper publisher whose product is seen by large numbers of people.

**LACK OF DEFAMATION.**— The lack of defamation defense is used when a publisher believes that no one has been defamed; and therefore, if it can be proved, there is no basis for a libel suit.

**CONSENT.**— Consent, as a libel defense, is used by a publisher when it can be shown that the person claiming libel previously consented to the statement that is now being challenged.

**STATUTE OF LIMITATIONS.**— Statute of limitations, as a complete defense against libel, means that a libel action was not brought within a maximum period of time as specified bylaw. The time limit varies from one year from the date of publication, in some states, to as many as three years in others. Beyond whatever deadline is established, no suit maybe filed.

## THE PRIVACY ACT

*LEARNING OBJECTIVE: Identify the basic provisions of the Privacy Act.*

All Navy journalists must have a working knowledge of the Privacy Act (PA) of 1974. The PA is an enclosure to the *Department of the Navy Privacy Act (PA) Program*, SECNAVINST 5211.5 series.

### PRIMARY FEATURES

Under the PA, government agencies may collect, store, disclose, account for and amend required personal information on military and civilian government employees. Additionally, individuals may request access to information about themselves. In the Navy, personal information may be collected and stored in roughly 200 PA record systems. An example of such a system is the Navy Civilian Personnel Data System (NCPDS).

The premise of the PA is simple. Everyone has a constitutional right to privacy. People do not waive that right simply because they are in the military or work for the government. Therefore, when you write a story about a person, there are a limited number of facts that may be released without the permission of that person.

### RELEASABLE INFORMATION — MILITARY

In the case of a military person, the following facts may be released:

- Name
- Rank
- Date of rank
- Gross salary
- Present and past duty assignments (subject to limitations addressed in SECNAVINST 5211.5 series)
- Future assignments that are officially established (subject to limitations addressed in SECNAVINST 5211.5 series)
- Office or duty telephone numbers
- Source of commission
- Promotion sequence number
- Awards and decorations
- Attendance at professional and military schools (major area of study, school, year of education and degree)
- Duty status at any given time

### RELEASABLE INFORMATION — CIVILIAN

When releasing information about government civilian employees, you may include the following facts without approval from the individuals concerned:

- Name
- Grade or position
- Date of grade
- Gross salary
- Present and past assignments
- Future assignments, if officially established
- Office telephone number

The point for you to remember is that, without a compelling reason that is usually in connection with the public concern, a person's privacy should not be violated. For you to pry into an individual's home life in connection with a news story is inexcusable unless there is some clear public need for the information. On the other hand a person cannot claim the right of privacy if an important news event has placed an individual, willingly or unwillingly, in public view. Even so, this

does not give the news media the right to push human dignity and decency aside.

Additional information on the PA may be found in SECNAVINST 5211.5 series or in *PA Regs*, Chapter 7.

## THE FREEDOM OF INFORMATION ACT

*LEARNING OBJECTIVE: Identify the basic provisions of the Freedom of Information Act.*

The Freedom of Information Act (FOIA) was established in 1966 to give the public the right to access records of the executive branch of the federal government. It established for the first time in U.S. history the right of “any person” to seek access to these records.

More than 40,000 FOIA requests are received annually from organizations and individuals. Requests center on the programs and activities of the DoD, including (but not limited to) the following:

- Projected retirees
- Decklogs
- Investigations
- Contracts
- Nuclear weapons
- Disposal of toxic substances

### AGENCY RECORDS

The FOIA provides for access to U.S. government “agency records” — simply stated, products that result from the gathering of data. They may include records originated by the agency or those it has received and maintained at the time of the FOIA request. Some examples of agency records include the following:

- Books
- Papers
- Maps
- Photographs
- Machine-readable materials or other documentary materials regardless of physical form or characteristics

You also must be aware of the records that **do not** qualify for release under the FOIA. Some of these records include the following:

- Objects or articles (such as structures, furniture, paintings, sculpture, three-dimensional models, vehicles and equipment)
- Administrative tools (such as computer software)
- Nontangible records (such as an individual’s memory or oral communication)
- Personal records not subject to agency creation/retention (such as notes to jog the memory of an employee)
- Unaltered publications and processed documents available to the public through other means (such as regulations, maps and manuals)

### FOIA REQUEST FORMAT

A request for an agency record under the FOIA must follow a specific format. First, and most important, make sure the request is in writing. Do not process verbal requests, whether in person or on the telephone. Additionally, the request must indicate that it is made under the provisions of the *Department of the Navy Freedom of Information Act (FOIA) Program*, SECNAVINST 5720.42 series, or its parent directives, DoD 5400.7 or DoD 5400.7-R.

The request also must contain a reasonable description of the record(s) requested. This will enable you or others in your office to research the request with more efficiency.

### FOIA FEES

All fees related to an FOIA request must be paid by the organization or person making the request. For commercial requesters, fees are assessed for the search, review and duplication of the requested records. All fees \$15 or under are automatically waived. However, in the case of educational institutions, noncommercial scientific institutions and news media representatives, fees can only be assessed for duplication (after the first 100 pages). All fees \$15 and under may be waived.

### FOIA ASSISTANCE

Occasionally, you will receive an FOIA request that does not meet the format previously described. Since

members of the public usually do not understand FOIA request procedures, it is up to you to help them.

## TIME LIMITS

You must respond to FOIA requests within 10 working days. However, this may be an unrealistic length of time because of your work schedule. When this happens, you may take a formal time extension of up to 10 additional working days if you must take one or more of the following actions:

- Search for or collect records that are located, in whole or in part, at places separate from the office processing the request.
- Search for, collect and examine a substantial number of records in response to a request.
- Consult with another naval activity or another agency which has a substantial subject matter interest in the determination of the request.

If you opt for a formal time extension, advise the requester in writing and give the reason(s) for the extension. Also indicate that the requester may make an appeal to the appropriate appellate authority (such as the judge advocate general or general counsel) within 60 calendar days.

Keep in mind that formal time extension letters must be approved and signed by higher authority. In FOIA terminology, this person is called the initial denial authority (IDA).

The purpose of this section is to acquaint you with some of the basic provisions of the FOIA Program. More detailed information can be found in SECNAVINST 5720.42 series and in *PA Regs*, Chapter 7.

## COPYRIGHT

*LEARNING OBJECTIVE: Define copyright and recognize its provisions.*

Another area of legal concern to the Navy journalist is the laws governing copyright, which, unlike libel laws, are federal statutes.

The copyright system is explained in detail in the Copyright Act of 1976 (Title 17 of the United States Code), which became effective on January 1, 1978. This act was the first general revision of the copyright law of the United States since 1909. It made a number of

changes in our copyright system, and for the most part, supersedes the previous federal copyright statute.

## DEFINITION

Copyright, according to the act, is a form of protection provided by the federal government to the authors of “original works of authorship fixed in any tangible medium of expression, now known or later developed, from which they can be perceived, reproduced or otherwise communicated, either directly or with the aid of a machine or device.”

Works of authorship include the following categories:

- Literary works
- Musical works, including any accompanying words
- Dramatic works, including any accompanying music
- Pantomimes and choreographic works
- Pictorial, graphic and sculptural works
- Motion pictures and other audiovisual works
- Sound recordings

It should be noted, however, that “copyright protection for an original work of authorship does not extend to any idea, procedure, process, system, method of operation, concept, principle or discovery, regardless of the form in which it is described, explained, illustrated or embodied in such work.”

Some other categories of material generally not eligible for statutory copyright protection include the following:

- Works that have not been fixed in a tangible form of expression; for example, choreographic works that have not been notated or recorded, or improvisational speeches or performances that have not been written or recorded
- Titles, names, short phrases and slogans; familiar symbols or designs; mere variations of typographic ornamentation, lettering or coloring; mere listings of ingredients or contents
- Works consisting entirely of information that is common property and containing no original authorship; for example, standard calendars, height and weight charts, tape measures and rules

and lists or tables taken from public documents or other common sources

Where copyright protection applies, it is available to both published and unpublished works. The Copyright Act generally gives the owner the exclusive right to do and to authorize others to do the following:

- To reproduce the copyrighted work in copies or phonorecords (phonorecords, for the purpose of this section, refers to material objects embodying fixations of sounds, such as cassette tapes, CDs or LPs)
- To prepare derivative works based upon the copyrighted work
- To distribute copies or phonorecords of the copyrighted work to the public by sale or other transfer of ownership or by rental, lease or lending
- To perform the copyrighted work publicly in the case of literary, musical, dramatic and choreographic works, pantomimes, motion pictures and other audiovisual works
- To display the copyrighted work publicly in the case of literary, musical, dramatic and choreographic works, pantomimes and pictorial, graphic or sculptural works, including the individual images of a motion picture or other audiovisual work

## LIMITATIONS

It is illegal for anyone to violate any of the rights provided to the owner of copyright by the act. These rights, however, are not unlimited in scope. In some cases, these limitations are specified exemptions from copyright liability.

One major limitation is the doctrine of “fair use,” which is now given a statutory basis by section 107 of the act, which states: the fair use of a copyright work, including such use by reproduction in copies or phonorecords or by any other means specified (in section 106 of the act), for purposes such as criticism, comment, news reporting, teaching (including multiple copies for classroom use), scholarship or research is not an infringement of copyright. In determining whether the use made of a work in any particular case is a fair use, you should consider the following factors:

1. The purpose and character of the use, including whether such use is of a commercial nature or is for nonprofit educational purposes

2. The nature of the copyrighted work

3. The amount and substantiality of the portion used in relation to the copyrighted work as a whole

4. The effect of the use upon the potential market for or value of the copyrighted work

In other instances, the limitation takes the form of a “compulsory license” under which certain limited uses of copyrighted works are permitted upon payment of specified royalties and compliance with statutory conditions.

## INFRINGEMENT

To use any of the exclusive rights of a copyright owner without permission is an infringement of copyright. Infringement is in violation of the law, and as such, it is punishable by the courts.

The owner of a copyright, upon proving that an infringement has occurred, can expect to recover from the offender any monetary loss suffered as well as any profit realized by the offender due to the infringement.

When a copyright is infringed by or for the U.S. government, the exclusive remedy of the copyright owner is, with the government’s permission, to bring suit against the United States in the Court of Claims. Government employees, including military personnel, are not personally liable for copyright infringement occurring in the performance of their official duties. In cases involving Navy personnel, claims of copyright infringement may be settled before the time suit is brought by the Secretary of the Navy or his duly authorized representative, the Chief of Naval Research or his designee.

To avoid the possibility of infringement, the best policy is to request permission from the owner before using any copyrighted material. The basic guidance for the procedures to be followed in obtaining copyright permission is contained in *Permission to Copy Materials Subject to Copyright*, SECNAVINST 5870.5 series, which covers the use of copyrighted materials in Navy publications, motion pictures, audiotapes, and videotapes and similar works.

## USE OF GOVERNMENT PUBLICATIONS

Any material published by or for the U.S. government, or any reprint in whole or in part thereof,

is generally considered to be in the public domain and not subject to copyright laws. However, when copyrighted material is used (with permission) in a government publication, it cannot be reproduced by a private citizen or in another government publication without again requesting permission from the copyright owner. Copyrighted material in a government publication must have a statement identifying the copyright holder and indicating that permission has been granted for its use.

## **COPYRIGHT OWNERSHIP**

Copyright protection exists from the time the work is created in fixed form; that is, it is an incident of the process of authorship. The copyright in the work of authorship immediately becomes the property of the author who created it. Only the author or those deriving their rights through the author can rightfully claim copyright.

In the case of works made for hire, as is the case when military personnel or civilian employees of the federal government author a “work” on government time, the employer and not the employee is presumptively considered the author. Section 101 of the copyright statute defines a “work made for hire” as the following:

1. A work prepared by an employee within the scope of his employment.
2. A work specially ordered or commissioned for use as a contribution to a collective work, as a part of a motion picture or other audiovisual work, as a translation, as a supplementary work, as a compilation, as an instructional text, as a test, as answer material for a test or as an atlas, if the parties expressly agree in a written instrument signed by them that the work shall be considered a work made for hire.

The authors of a joint work are co-owners of the copyright in the work unless there is an agreement to the contrary.

Copyright in each separate contribution to a periodical or other collective work is distinct from copyright in the collective work as a whole and vests initially with the author of the contribution.

Mere ownership of a book, manuscript, painting or any other copy or phonorecord does not give the possessor the copyright. The law provides that transfer of ownership of any material object that embodies a protected work does not of itself convey any rights in the copyright.

Minors may claim copyright, but state laws may regulate the business dealings involving copyrights owned by minors. For information on relevant state laws, you may wish to contact your local bar association.

## **COPYRIGHT AVAILABILITY**

Copyright protection is available for all unpublished works regardless of the nationality or domicile of the author.

Published works are eligible for copyright protection in the United States if any one of the following conditions is met:

- On the date of first publication, one or more of the authors is a national or domiciliary of the United States or is a national, domiciliary or sovereign authority of a foreign nation that is a party to a copyright treaty to which the United States also is a party or is a stateless person wherever that person may be domiciled.
- The work is first published in the United States or in a foreign nation that, on the date of first publication, is a party to the Universal Copyright Convention; or the work comes within the scope of a presidential proclamation.
- The work is first published on or after March 1, 1989, in a foreign nation that on the date of first publication, is a party to the Berne Convention; or, if the work is **not** first published in a country party to the Berne Convention, it is published (on or after March 1, 1989) within 30 days of first publication in a country that is party to the Berne Convention.
- The work is first published on or after March 1, 1989, and is a pictorial, graphic, or sculptural work that is incorporated in a permanent structure located in the United States; or, if the work, first published on or after March 1, 1989, is a published audiovisual work and all the authors are legal entities with headquarters in the United States.

## **SECURING A COPYRIGHT**

The way in which copyright protection is secured under the present law is frequently misunderstood. No publication or registration or any other action in the Copyright Office is required for copyright to be secured under the new law. This differs from the old law, which

required either publication with the copyright notice or registration in the Copyright Office.

Before 1978, statutory copyright was generally secured by the act of publication with notice of copyright, assuming compliance with all other relevant statutory conditions. Works in the public domain on January 1, 1978, (for example, works published without satisfying all conditions for securing statutory copyright under the Copyright Act of 1909) remain in the public domain under the current act.

Statutory copyright also could be secured before 1978 by the act of registration in the case of certain unpublished works and works eligible for ad interim copyright. The current act automatically extends to full-term copyright for all works in which ad interim copyright was existing or could be secured on December 31, 1977.

Under the new law copyright is secured automatically when the work is created, and a work is “created” when it is fixed in a copy or phonorecord for the first time. Generally, “copies” are material objects from which a work can be read or visually perceived either directly or with scripts, sheet music, film, videotape or microfilm. As mentioned earlier, phonorecords are material objects embodying fixations of sounds. ‘his also applies to a work such as a song, fixed on sheet music (“copies”), CDs (“phonorecords”) or both.

If a work is prepared over a period of time, the part of the work existing in fixed form on a particular date constitutes the created work as of that date.

## **PUBLICATION**

Publication is no longer the key to obtaining statutory copyright as it was under the Copyright Act of 1909. However, publication remains important to copyright owners.

The Copyright Act defines publication as follows:

“Publication is the distribution of copies or phonorecords of a work to the public by sale or other transfer of ownership or by rental, lease or lending. The offering to distribute copies or phonorecords to a group of persons for purposes of further distribution, public performance or public display, constitutes publication. A public performance or display of a work does not of itself constitute publication.”

Further coverage of the definition of “publication” is contained in the legislative history of the act. The

legislative reports define “to the public” as distribution to persons under no explicit or implicit restrictions with respect to disclosure of the contents. The reports state that the definition makes it clear that the sale of phonorecords constitutes publication of the underlying work; for example, the musical, dramatic or literary work embodied in a phonorecord.

The reports also state that it is clear that any form or dissemination in which the material object does not change hands — for example, performances or displays on television — is not a publication no matter how many people are exposed to the work. However, when copies or phonorecords are offered for sale or lease to a group of wholesalers, broadcasters or motion-picture theaters, publication does take place if the purpose is further distribution, public performance or public display.

Publication is an important concept in the copyright law for several reasons:

- When a work is published, it may bear a notice of copyright to identify the year of publication and the name of the copyright owner and to inform the public that the work is protected by copyright. Works published before March 1, 1989, **must** bear the notice or risk loss of copyright protection
- Works that are published in the United States are subject to mandatory deposit with the Library of Congress.
- Publication of a work can affect the limitations on the exclusive rights of the copyright owner that are set forth in sections 107 through 120 of the law.
- The year of publication may determine the duration of copyright protection for anonymous and pseudonymous works (when the author’s identity is not revealed in the records of the Copyright Office) and for works made for hire.
- Deposit requirements for registration of published works differ from those for registration of unpublished works.

## **NOTICE OF COPYRIGHT**

*LEARNING OBJECTIVE: Recognize how a notice of copyright is displayed on a copyrighted work.*



For works first published on and after March 1, 1989, use of the copyright notice is optional, though highly recommended. Before March 1, 1989, the use of the notice was mandatory on all published works, and any work first published before that date must bear a notice or risk loss of copyright protection. (The Copyright Office does not take a position on whether works first published with notice before March 1, 1989, and reprinted and distributed on and after March 1, 1989, must bear the copyright notice.)

Use of the notice is recommended because it informs the public that the work is protected by copyright, identifies the copyright owner, and shows the year of first publication. Additionally, in the event that a work is infringed, if the work carries a proper notice, the court will not allow a defendant to claim “innocent infringement” — that is, that he did not realize the work is protected (a successful innocent infringement claim may result in a reduction in damages that the copyright owner would otherwise receive).

The use of the copyright notice is the responsibility of the copyright owner and does not require advance permission from, or registration with, the Copyright Office.

#### **FORM OF NOTICE FOR VISUALLY PERCEPTIBLE COPIES**

The notice for visually perceptible copies should contain the following three elements:

- **The symbol ©** (the letter C in a circle), the word “Copyright” or the abbreviation “Copr.”
- **The year of first publication of the work.** In the case of compilations or derivative works incorporating previously published material, the year date of first publication of the compilation or derivative work is sufficient. The year date may be omitted where a pictorial, graphic or sculptural work, with accompanying textual matter, if any, is reproduced in or on greeting cards, postcards, stationery, jewelry, dolls, toys or any useful articles.
- **The name of the owner of copyright** in the work, an abbreviation by which the name can be recognized or a generally known alternative designation of the owner. Note the following example:

© 1993 Jack Crevalle

The “C in a circle” notice is required only on “visually perceptible copies.” Certain kinds of works, for example, musical, dramatic and literary works, may be fixed not in “copies” but by means of sound in an audio recording. Since audio recordings, such as audiotapes and phonograph discs, are “phonorecords” and not “copies,” there is no requirement that the phonorecord bear a “C in a circle” notice to protect the underlying musical, dramatic or literary work that is recorded.

#### **FORM OF NOTICE FOR PHONORECORDS OF SOUND RECORDINGS**

The copyright notice for phonorecords of sound recordings has somewhat different requirements. The notice appearing on phonorecords should contain the following three elements:

- **The symbol ℗** (the letter P in a circle)
- **The year of first publication** of the sound recording
- **The name of the owner of copyright** in the sound recording, or an abbreviation by which the name can be recognized, or a generally known alternative designation of the owner. When the producer of the sound recording is named on the phonorecord labels or containers and when no other name appears in conjunction with the notice, the producer’s name should be considered a part of the notice. Consider the following example:

℗ Jack Crevalle

#### **POSITION OF NOTICE**

The notice should be affixed to copies or phonorecords of the work in such a manner and location as to “give reasonable notice of the claim of copyright.” The notice on phonorecords may appear on the surface of the phonorecord or on the phonorecord label or container, provided the manner of placement and location gives reasonable notice of the claim. The three elements of the notice should ordinarily appear together on the copies or phonorecords.

#### **PUBLICATION INCORPORATING UNITED STATES GOVERNMENT WORKS**

Works by the U.S. government are not eligible for copyright protection. For works published on and after March 1, 1989, the previous notice requirement for

## COPYRIGHT REGISTRATION

*LEARNING OBJECTIVE: Recognize the procedures used to obtain a copyright and the rules that apply to the copyright owner.*

works consisting primarily of one or more U.S. government works has been eliminated. However, use of the copyright notice for these works is still strongly recommended. The use of a notice on such a work will defeat a claim of innocent infringement, as previously described, **provided** the notice also includes a statement that identifies one of the following:

- Those portions of the work in which copyright is claimed.
- Those portions that constitute U.S. government material. Note the following example:

© 1993 Jack Crevalle. Copyright claimed in Chapters 7-10, exclusive of U.S. government maps.

Works published before March 1, 1989, that consist primarily of one or more works of the U.S. government **must** bear a notice and the identifying statement.

### UNPUBLISHED WORKS

The copyright notice is not required on unpublished works. To avoid an inadvertent publication, without notice, however, it may be advisable for the author or other owner of the copyright to affix notices to any copies or phonorecords that leave his control.

### CORRECTING ERRORS AND OMISSIONS

Unlike the law that was in effect before 1978, sections 405 and 406 in the new Copyright Act provide procedures for correcting errors and omissions of the copyright notice on works published on or after January 1, 1978, and before March 1, 1989.

Generally, the omission or error does not automatically invalidate the copyright in a work if registration for the work has been made before, or is made within five years after the publication without notice. Also, to add the notice to all copies or phonorecords distributed to the public in the United States after the omission has been discovered, a reasonable effort is required.

Before 1978 (as a condition for copyright protection), the copyright law required all copies published with the authorization of the copyright owner to bear a proper notice. When a work was published under the copyright owner's authority before January 1, 1978, without a proper copyright notice, all copyright protection for that work was permanently lost in the United States. The new copyright law does not provide retroactive protection for those works.

Generally, copyright registration is a legal formality intended to make a public record of the basic facts of a particular copyright. However, except in one specific situation, registration is not a condition of copyright protection. That exception is contained in sections 405 and 406 of the Copyright Act. The act provides that copyright registration may be required to preserve a copyright that would otherwise be invalidated because of the omission of the copyright notice from the published copies or phonorecords, omission of the name or date or a certain error in the year date.

Even though registration is not generally a requirement for protection, the copyright law provides several inducements or advantages to encourage copyright owners to register. Some of these advantages are as follows:

- Registration establishes a public record of the copyright claim.
- Before an infringement suit maybe filed in court, registration is necessary for works of U.S. origin and for foreign works not originating in a Berne Union country.
- If made before or within five years of publication, registration will establish prima facie evidence in court of the validity of the copyright and of the facts stated in the certificate.
- If registration is made within three months after publication of the work or before an infringement of the work, statutory damages and attorney's fees will be available to the copyright owner in court actions. Otherwise, only an award of actual damages and profits is available to the copyright owner.

Registration may be made at any time within the life of the copyright. Unlike the law before 1978, when a work has been registered in unpublished form, another registration is not necessary when the work is published, although the copyright owner may register the published edition, if desired.

## REGISTRATION PROCEDURES

If you choose to register your work, you should send the following three elements to the Copyright Office in the same envelope or package:

- A properly completed application form
- A fee of \$20 for each application
- A deposit of the work being registered

The deposit requirements will vary in particular situations. The general requirements are as follows:

- If the work is unpublished one complete copy or phonorecord
- If the work was published in the United States on or after January 1, 1978, two complete copies or phonorecords of the best edition
- If the work was first published in the United States before January 1, 1978, two complete copies or phonorecords of the work as first published
- If the work was first published outside the United States, whenever published one complete copy or phonorecord of the work as first published
- If the work is a contribution to a collective work and published after January 1, 1978, one complete copy or phonorecord of the best edition of the collective work

**NOTE:** The Copyright Office has the authority to adjust fees at five-year intervals, based on changes in the Consumer Price Index. Contact the Copyright Office for the most current fees.

## COPYRIGHT DURATION

A work that is created (fixed in tangible form for the first time) on or after January 1, 1978, is automatically protected from the moment of its creation and is ordinarily given a term enduring for the author's life — plus an additional 50 years after the author's death. In the case of "a joint work prepared by two or more authors who did not work for hire," the term lasts for 50

years after the last surviving author's death. For works made for hire and for anonymous and pseudonymous works (unless the author's identity is revealed in Copyright Office records), the duration of copyright will be 75 years from publication or 100 years from creation, whichever is shorter.

Works that were created, but not published or registered for copyright before January 1, 1978, automatically have been brought under the statute and are now given federal copyright protection. The duration of copyright in these works generally is computed in the same way as for works created on or after January 1, 1978; the life-plus-50 or 75/100-year terms will apply to them as well. The law provides that in no case will the term of copyright for works in this category expire before December 31, 2002, and for works published on or before December 31, 2002, the term of copyright will not expire before December 31, 2027.

Under the law in effect before 1978, copyright was secured either on the date a work was published or on the date of registration if the work was registered in unpublished form. In either case, the copyright lasted for a first term of 28 years from the date it was secured. During the last (28th) year of the first term, the copyright was eligible for renewal. The current copyright law has extended the renewal term from 28 to 47 years for copyrights that were subsisting on January 1, 1978, making these works eligible for a total term of protection of 75 years.

Public Law 102-307, enacted on June 26, 1992, amended the Copyright Act of 1976 and automatically extended the term of copyrights secured between January 1, 1964, and December 31, 1977 to the further term of 47 years and increased the filing fee from \$12 to \$20. This fee increase applies to all renewal applications filed on or after June 29, 1992.

Under Public Law 102-307, renewal registration is optional. There is no need for the renewal filing to be made in order for the original 28-year copyright term to be extended to the full 75 years. However, some benefits accrue to making a renewal registration during the 28th year of the original term.



## CHAPTER 11

# BASIC PHOTOGRAPHY

How much does a Navy journalist need to know about photography? Some JOs are expert photographers, while others resort to asking imaging facility personnel for photographic coverage of an event.

The fact remains that you will be tested on your knowledge of photography. At some point in your career, your supervisor will expect you to know the fundamentals of photography, to take news photographs with good composition, to use standard Navy darkroom equipment to process exposed film and to produce contact and projection prints.

If you can do these things already, you have a very important trait needed in the JO rating — **versatility**. However, if photography is not your strong suit, pay particular attention to the information in this chapter and the one that follows (“Basic Photojournalism,” Chapter 12). Also, there is nothing like hands-on experience. Ask a senior JO for some on-the-job training or contact the nearest Navy imaging facility for instruction.

**NOTE:** This chapter is intended to acquaint you with the basic concepts of photography. For more detailed information, consult the *Photography* (Basic) and *Photography* (Advanced) TRAMANS.

### THE PHOTOGRAPHIC PROCESS

*LEARNING OBJECTIVE: Identify the basic process of photography.*

The basic equipment required for the photographic process, as shown in figure 11-1, includes the following components:

- A subject
- A light source
- A camera
- Photographic film
- Chemicals for processing film
- A printing device
- Photographic paper

- Chemicals for processing paper

### SUBJECT

The subject can be anything. If it can be seen, it can be photographed. Just as there must be light to form an image, there must be a subject from which to form the image.

### FILM

Film, as defined in this chapter, is a light-sensitive emulsion of silver halides suspended in gelatin and coated on a transparent and chemically neutral base, usually cellulose or polymer plastic. The choice of film type is determined by the size and the sensitivity required by both the camera and the nature of the light to be used. During the exposure, silver halide crystals in the emulsion undergo anionic change forming a latent image that can then be reduced to a visible and usable image through a complex chemical process.

### CAMERA

The camera is essentially a lighttight box with an optical system at one end and an image support at the other. Additions to the basic camera have been made to improve focusing the image, viewing, controlling the amount and duration of light entering the box, film changing or rolling and range and exposure calculators. While these improvements are valuable, they are not absolutely essential to the photographic process. A picture can be made with a coffee can if it has a pinhole at one end and a support for film at the other.

### FILM PROCESSING

The processing of film to convert the latent image into a stable, visible image for use in printing requires you to carry out the following four basic steps:

- Developing or converting exposed silver halides to metallic silver — the black or dark portions of the visible image
- Fixing or changing the silver halides unaffected by the developing to soluble salts

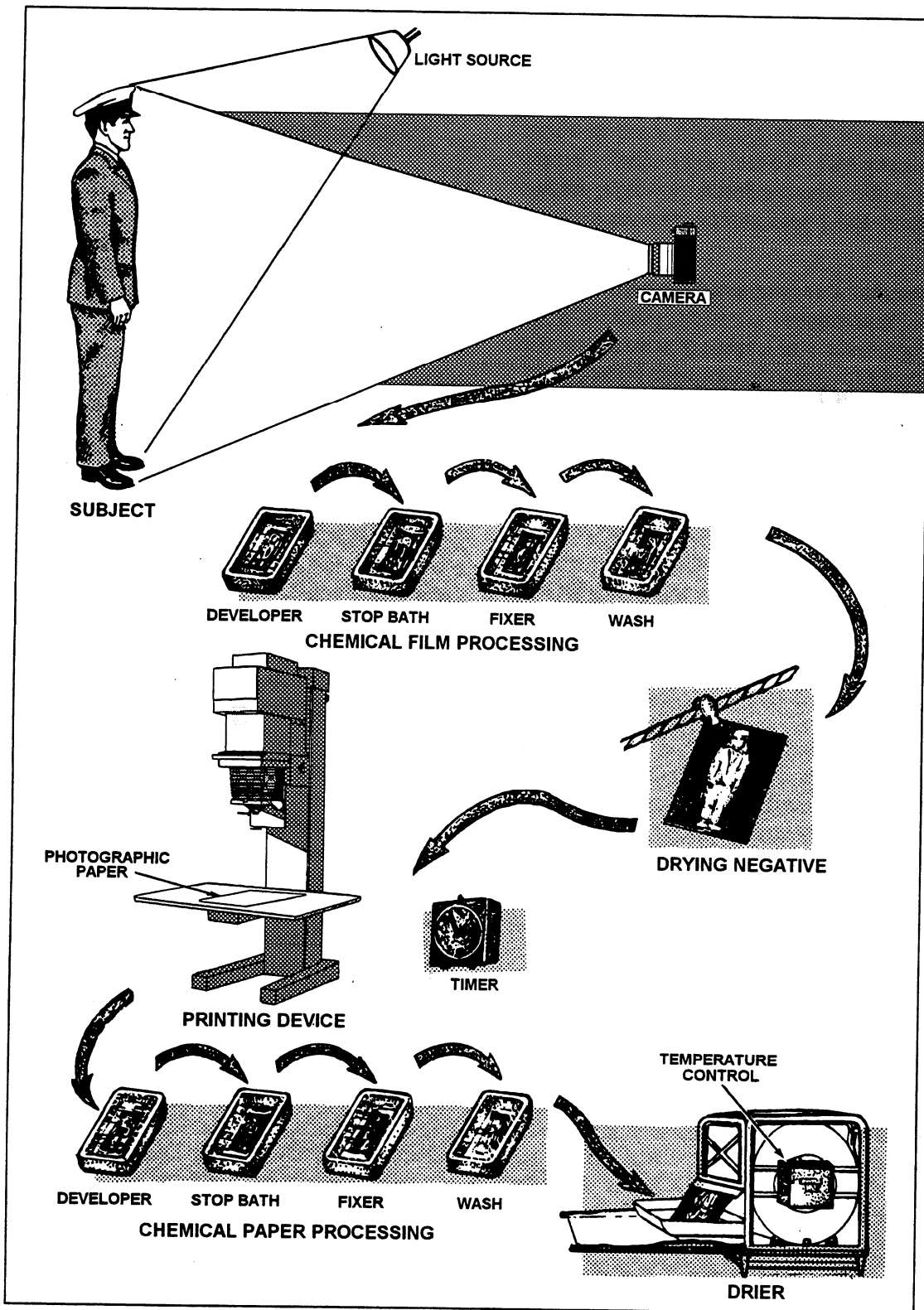

Figure 11-1.—The photographic process.

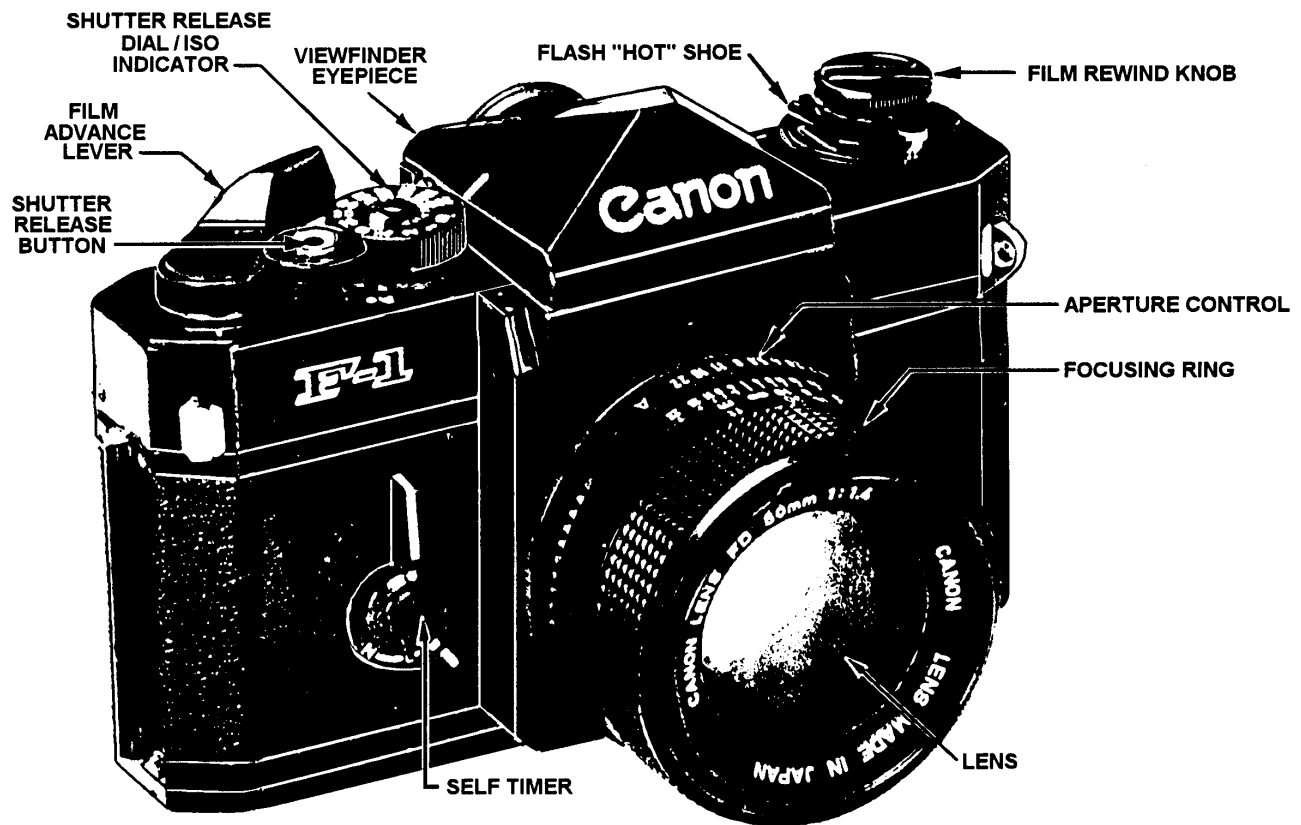

Figure 11-2.—The 35mm single-lens reflex (SLR) camera.

AN R. B. Burrows

- Washing to remove the soluble salts and residual chemicals
- Drying the film for handling

Once these steps have been completed, you have a negative ready for printing.

## PRINTING DEVICES

Printing the negative, or making a positive, is done by contact or projection. The contact printer is usually a box with an internal light source and a piece of glass that allows light to pass through it and the negative to form a latent image on photographic paper held in contact with the negative.

The projection printer allows the image on the negative to be projected and the size of the print varied. This type of printer consists of a light source, a negative holder and a lens and focusing device mounted on a frame which can be raised and lowered, depending on the size of the projected image desired. The photographic paper is held in an easel.

## PHOTOGRAPHIC PAPER

Photographic paper has essentially the same emulsion as film. The chemical process is the same as that for film but produces a positive image. Choice of paper types is dependent upon the type of printing, surface, size and finish desired.

## THE 35MM SINGLE-LENS REFLEX CAMERA

*LEARNING OBJECTIVE: Identify the basic parts of a 35mm single-lens reflex camera.*

As a Navy journalist, the 35mm single-lens reflex (SLR) camera (fig. 11-2) will serve as your tool to tell a story with photographs. For this reason it is important for you to become as familiar as possible with your camera, know what the camera can do, then know what you want it to do.

The SLR camera gets its name from the use of a mirror to reflect an image formed by a single viewing and taking lens onto a viewing screen for focusing. A

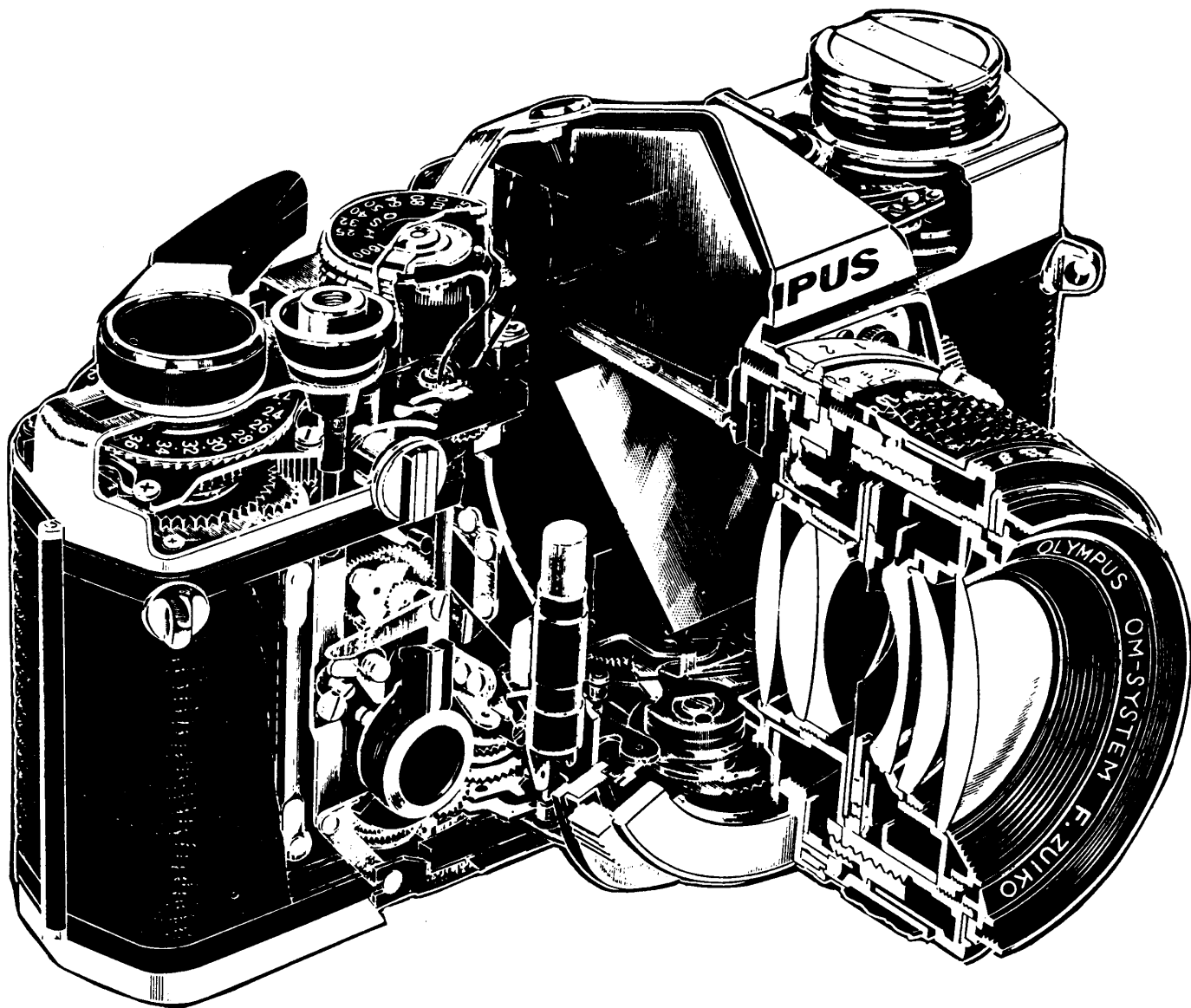

**Figure 11-3.—A cutaway view of a 35mm SLR camera.**

cutaway view of a 35mm SLR camera is shown in figure 11-3, and the basic principle of the SLR camera is shown in figure 11-4.

The mirror, set at a 45-degree angle to the optical axis, reflects the image through a pentaprism that accomplishes vertical and lateral correction of the image. At the moment of exposure, viewing is disrupted for a split second, as the spring-operated mirror swings out of the lens-to-film optical path. The mirror then automatically returns to its original position for the next exposure.

Important advantages of the SLR design are the ease of viewing and focusing and the photographer's ability to judge the effect of the depth of field at a selected aperture. Depth of field will be covered later in this chapter.

Probably the most important advantage of the SLR camera is the ease with which it can be used. Its small size and compactness enables photographers to carry them strapped around their neck or over their shoulder. Little preparation is necessary for them to be put into operation. Another advantage is the rapid film-changing devices incorporated into the cameras. They can be used to great advantage when many photographs must be made in a short period of time. Design of the average SLR camera is such that minimum time is required for making the settings and winding the film.

Because most SLR cameras make as many as 36 exposures on a single roll of 35mm film, the photographer can carry enough film in one pocket to make many exposures. This type of camera is helpful for news and action photography where several pictures must be made in a short time. It is also indispensable for color slide work.



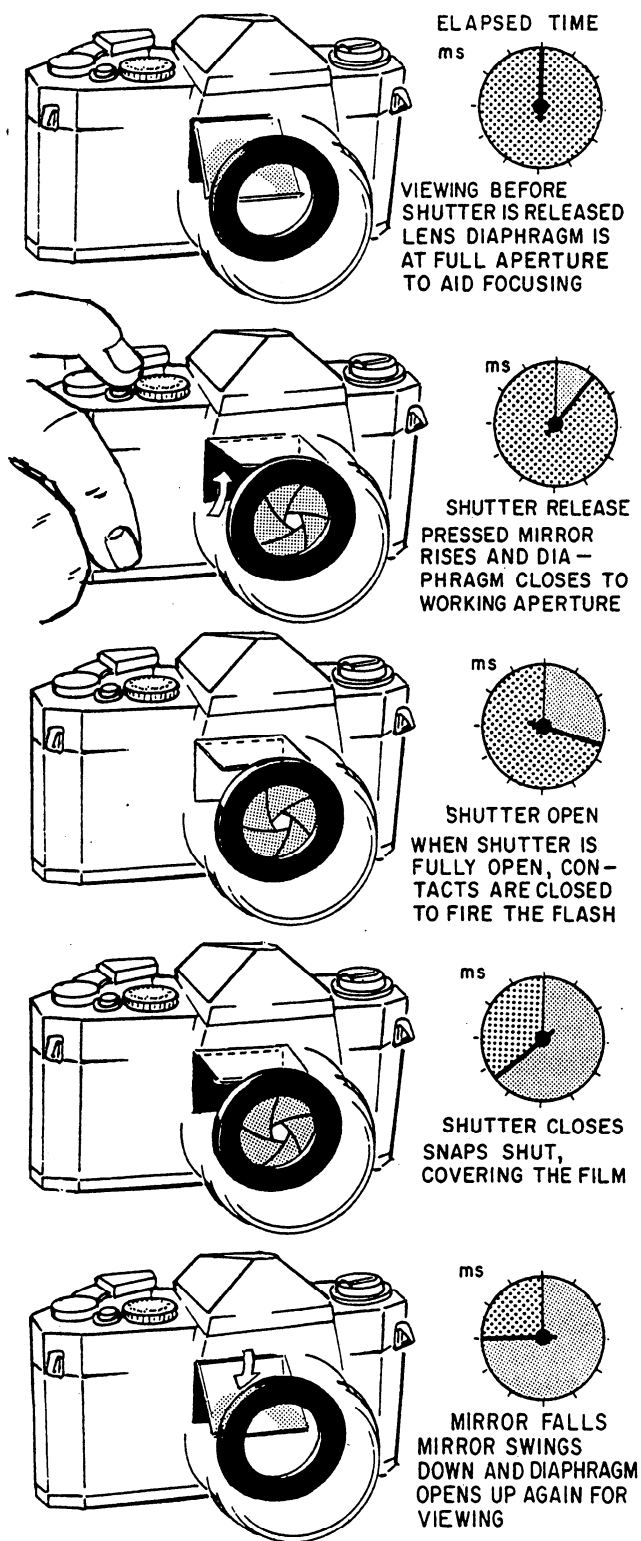

Figure 11-4.—The basic principle of a 35mm SLR camera.

Modern SLR cameras accept a vast assortment of lenses, ranging from fisheye to extreme long-focus types. With their interchangeability of lenses, film backs and other accessories (such as electronic flash attachments), SLRs can more aptly be called camera “systems.”

Lenses are usually attached to the camera by a bayonet flange. Focusing is done by turning the lens focusing ring. A screw thread, which runs around the inside of the lens barrel, moves the lens closer or farther away from the film, as the focusing ring is turned.

Most SLR camera lenses have an iris diaphragm. This diaphragm is held at full aperture for focusing and viewing and is stopped down automatically to the preset working aperture at the instant of exposure. This means that while the image on the viewing screen is bright and easy to see, only the correct amount of light reaches the film for exposure.

Your SLR camera will have a built-in exposure meter that usually reads “through the lens” (TTL). The meter may measure the light falling on the mirror, the focusing screen, or in some models, even on the film at the instant of exposure. On an automatic camera, the meter even adjusts the aperture or shutter speed to give the correct exposure. On manual cameras the meter produces a display in the viewfinder to indicate the correct exposure. The user then sets the camera controls to get the correct exposure.

Almost all SLRs have final-plane shutters. They simplify the construction of the camera and make the use of interchangeable lenses easier. The shutter, aperture and mirror all work together in a precise sequence, repeated each time a picture is taken.

The relatively small size, ease and speed of operation, reliability and the high quality of photographs of the SLR cameras have combined to make it a favorite of professional photographers and photojournalists.

## CONTROLS AND INDICATORS

In the Navy, most photojournalists are issued a camera kit that consists of a Canon F-1 35mm SLR camera, a 50mm lens, a 35mm lens, a 135mm lens and a flash unit. This camera is shown in figure 11-2.

Some of the main controls and indicators of the 35mm SLR camera are covered in the following text.

### Film Advance Lever

The film advance lever advances the film one frame at a time, cocks the shutter, prepares the aperture and mirror for exposure and advances the frame counter one number.

## Shutter Release Button

The shutter release button opens the shutter and initiates the exposure.

## Shutter Speed Dial

The shutter speed dial indicates optional shutter speeds and sets the length of time the shutter remains open during an exposure. Shutter speeds are indicated in fractions of a second; for example, 60 = 1/60 of a second (also expressed as 1/60"). The higher the number on the dial, the faster the shutter speed and the shorter the exposure.

## ISO Indicator

The ISO (International Standards Organization) indicator allows you to compensate for the particular "speed" of your film. For example, if you are shooting black-and-white film with an ISO of 400, you will set your ISO indicator to 400. The higher the ISO, the more light sensitive the film.

## Aperture Control

The aperture control is a ring around the lens with a scale listing aperture numbers (2.8, 3.5, 4, 5.6, etc.). These numbers are also known as "f/stops." The ring sets the f/stop on the lens to control the amount of light entering the lens.

## Film Rewind Knob

The film rewind knob is used to rewind the film into the cassette (film canister), to tighten slack in loaded film and to open the back of the camera. You turn the knob in the direction of the arrow to rewind the film, and lift it to open the back of the camera.

## LENSES AND APERTURES

As noted previously, most 35mm SLRs have interchangeable lenses. The "final length" of a lens is the distance from the optical center of the lens to the final plane (film plane) when the camera is focused upon an object at infinity. A 50mm final-length lens is considered the "normal" lens because when you look through the viewfinder, objects appear at their approximate normal size. A smaller than normal focal length (such as 28mm) means a wider angle of view. A longer than normal final length (such as 135mm) is a telephoto lens. Focal length affects film image size.

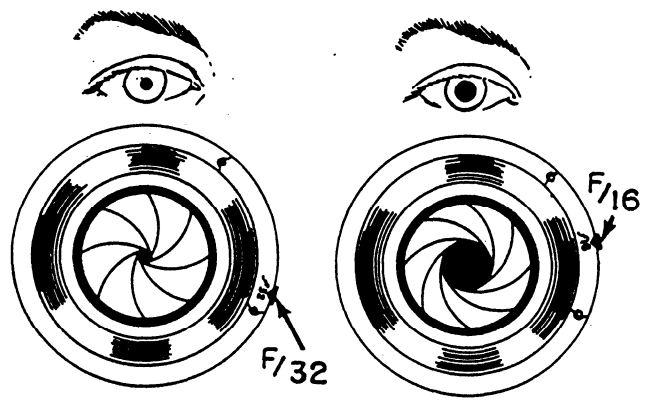

Figure 11-5.—Comparison of the iris diaphragm of a camera lens to the iris of the human eye.

The f/stop (aperture) ring controls the amount of light passing through the iris diaphragm of the lens and striking the film. The higher the f/stop number, the smaller the amount of light allowed to enter the camera lens. This principle works in the same manner as the iris of the human eye (fig. 11-5).

## OPERATING THE 35MM SLR CAMERA

*LEARNING OBJECTIVE: Determine the proper operating procedures for the 35mm SLR camera.*

The components of a 35mm SLR camera are of little consequence if you do not know how to use them together. In this section, you will learn how to perform the following functions:

- Loading
- Holding the camera
- Focusing the camera
- Setting the film speed
- Activating the light meter
- Setting the shutter speed
- Setting the aperture control
- Shooting the picture
- Unloading the film

## LOADING

You should load the camera in subdued light (not direct sunlight) and use the following method:

1. Place the film in the chamber, grasp the beginning of the film (called the leader) and feed it onto the sprockets of the take-up spool.

2.- Move the film advance lever forward, depress the shutter release button, and again advance the film one frame.

3. Close the back of the camera carefully and depress the shutter release button.

4. Advance the film another frame and **watch the rewind knob to make sure it moves.**

If the rewind knob does not move, either you loaded the film incorrectly or there is still some slack in the film cassette. The latter situation can be checked by your gently rotating the rewinding knob clockwise without depressing the rewind button on the bottom of the camera (as is usually done when rewinding film).

### HOLDING THE CAMERA

Although you may hold the camera in any manner that best suits you, give serious consideration to the method described in the following text. It will give you a steady platform for the camera that will help you reduce camera movement.

Grasp the camera on the right side with your right hand (fig. 11-6). Use the index finger of your right hand

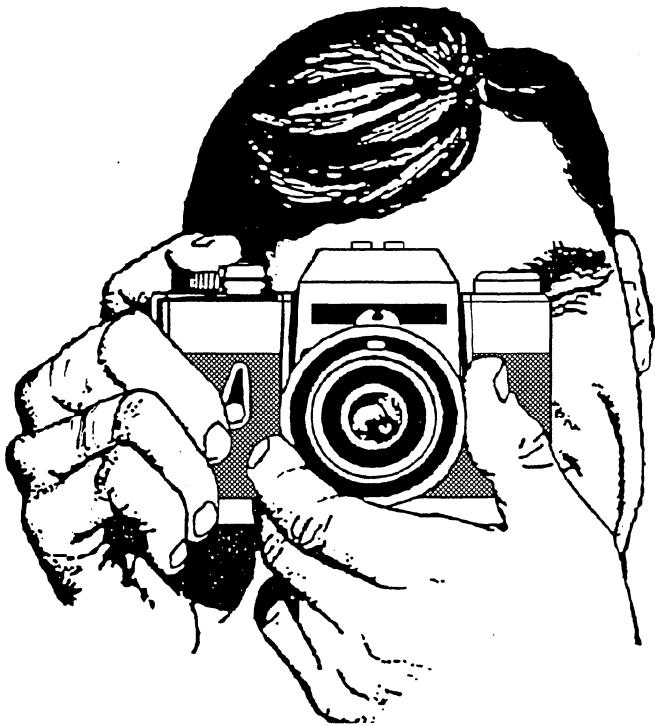

Figure 11-6.—Holding the camera.

to depress the shutter release button and the thumb of your right hand to advance the film. Adjust the shutter speed control with the index finger and thumb of the right hand.

Use the index finger and thumb of your left hand to adjust the aperture and focus. For horizontal shots, place both of your elbows against your body for support. When you take vertical format shots, your left elbow should be placed against the body for support. Cradle telephoto lenses in your left hand.

### FOCUSING THE CAMERA

A camera is focused by moving the lens closer or farther from the film (focal) plane. The two basic methods of focusing are scale focusing and SLR focusing. Both types of focusing are covered in the following text.

#### Scale Focusing

In scale focusing, you use a scale of distances to which the lens is set. This scale maybe inscribed on the lens barrel or on the camera frame (fig. 11-7), depending on the camera design.

Scale focusing is used primarily with small aperture lenses that have sufficient depth of field to overcome small camera-to-subject distance estimate or measurement errors. To use the focusing scale, you must estimate in most cases, the camera-to-subject distance.

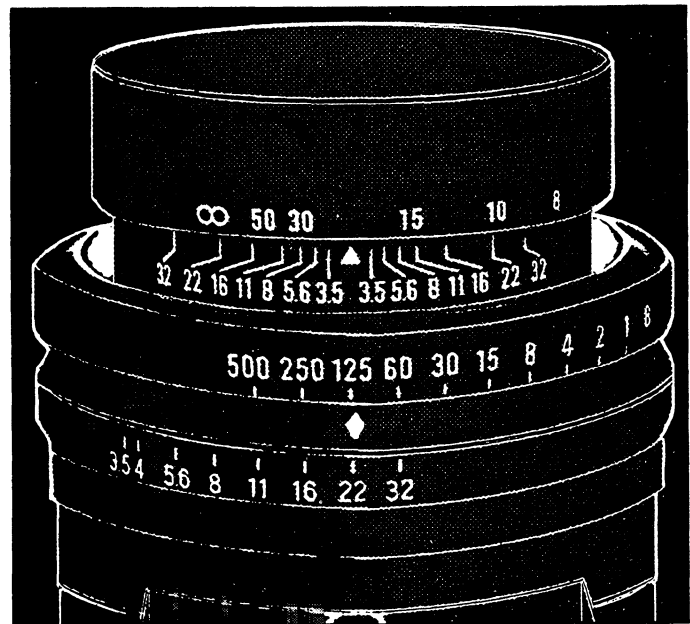

Figure 11-7.—Focusing scale on a camera lens.

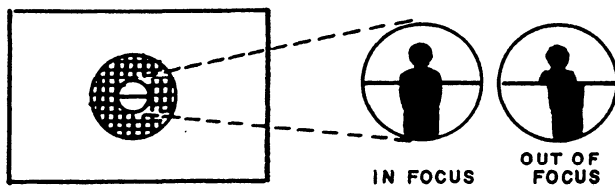

Figure 11-8.—Split image focusing in a SLR camera.

This estimated distance is then set to the focus index mark on the lens or other focus index on the camera. The most accurate way to use focusing scales, of course, is to measure the camera-to-subject distance with a tape measure.

### SLR Focusing

The SLR camera has a focusing and viewing system that shows you the image formed by the taking lens. It is designed so the distance between the focusing screen and lens is exactly the same as that between the lens and the film. Therefore, whatever appears in focus on the focusing screen also will be recorded in focus on the film.

Sometimes two small prisms or a split screen is included in the central area of a SLR camera viewing screen. When the image is out of focus, it appears split in this area. Some screens have a central grid of minute prisms that produce a shimmering effect when the image is out of focus (fig. 11-8).

You focus a SLR camera by rotating the focusing ring on the lens until the image seen on the viewing screen is in sharp focus.

### SETTING THE FILM SPEED

No matter how experienced you are, you should make sure the film speed indicator matches the ISO of the film you are using. The indicator is part of the shutter speed dial of most 35mm SLRs.

### ACTIVATING THE LIGHT METER

The light meter on-off switch is located on the back of the Canon F-1 (refer to the instruction manual for other camera models). A light-sensitive photocell moves a meter needle inside the viewfinder. When the meter needle is in line with the aperture needle, the camera is set for a proper exposure. The light meter can be left on throughout your shooting assignment. An example of a light meter is shown in figure 11-9.

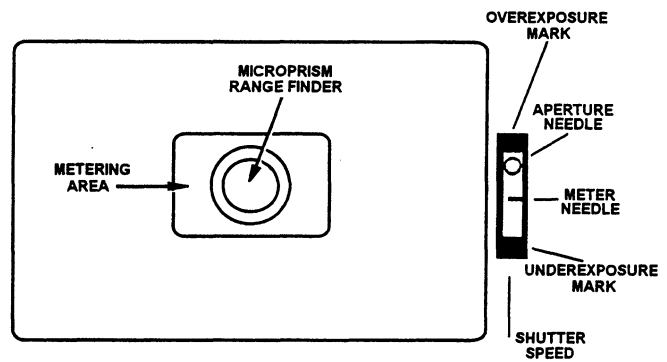

Figure 11-9.—Light meter.

### SETTING THE SHUTTER SPEED

The film manufacturer's instructions provide time-tested shutter speeds for varying light renditions, such as sunny, overcast and cloudy. However, on occasion, you may prefer to freeze action or blur motion. In these situations you must manipulate both the shutter speed and the aperture control ring. For instance, you may set your camera at 1/60" to illustrate the speed of a runner — his legs and arms are a blur of motion on the finished photograph.

Consequently, if you want to freeze the action, you set your camera at 1/250" or higher. Then the runner's legs, arms and victory expression are "frozen." For hand-held shots, choose a shutter speed no slower than the speed closest to the focal length of the lens. For example, you would select 1/60" for a 50mm lens and 1/250" for a 250mm lens.

### SETTING THE APERTURE CONTROL

Adjust the f/stop on the aperture control ring to match the light meter requirement. The aperture control can be used to increase or decrease the depth of field, which will be explained in detail later in this chapter.

### SHOOTING THE PICTURE

Much like pulling the trigger on a rifle, you should depress the shutter release button lightly until the camera clicks. Advance the film to the next frame and you are set for the next exposure.

### UNLOADING THE FILM

One of the most common mistakes photographers make is failing to wind the 35mm film back into the cartridge **before opening the back of the camera.**

After you have exposed all frames, depress the rewind button (normally at the bottom of the camera) and slowly rewind the film. Rewinding too quickly, especially in cold weather, could crack the film or cause static electricity that will damage the film. When the film is completely rewound, you will no longer feel tension on the rewind knob.

Store the exposed film in a dry, dark container (such as a photo bag) or in its original canister until it is ready for developing. If your assignment requires you to shoot more than one roll of film, number the rolls directly on the canister using a china marker or laundry marking pen.

## INSPECTING AND MAINTAINING THE CAMERA

*LEARNING OBJECTIVE: Identify the correct method of inspecting and maintaining the 35mm single-lens reflex camera.*

The importance of caring for your camera cannot be overstated. The old saying, "Take care of your equipment, and it will take care of you," certainly holds true when it comes to photography. In the following text you will learn the basics of periodic camera inspection and maintenance, to include the lens, camera body and camera optics.

**NOTE:** You may be held liable for any damages while the camera is in your custody!

### THE LENS

Remove the lens from the camera according to the manufacturer's instructions. Inspect the lens and check it for dirt, smudges, fingerprints and scratches. Remove dirt with a blower brush; eliminate smudges and fingerprints by gently wiping the glass with lens-cleaning tissue moistened with a few drops of lens-cleaning solution. Be careful not to oversaturate the tissue — one or two drops should be enough.

Minor scratches may not alter the performance of the lens, but you should bring them to the attention of your LPO or LCPO. However, deep scratches will probably affect the performance of your lens. In this instance, notify your supervisor and obtain a replacement lens. If you are not sure about the severity of a scratch, reattach the lens to the camera body, look through the viewfinder and focus on a subject. If any part of the field of view appears blurred or obscured, replace the lens.

Next, check the aperture control ring. The ring should click firmly into each position. Examine the focus ring. It should move smoothly, without interruption. Check the lens exterior for dents and other damage.

Finally, make sure the lens is mounted with an ultraviolet, haze or skylight filter to protect the front glass surface and its delicate antireflective coating.

### THE CAMERA BODY

Inspect the camera body for dirt and defects. Use a blower brush to remove light dust and dirt; stubborn dirt can be removed with a silicon cloth or a soft chamois. **Do not use liquids to clean the camera body.** Liquid cleaners, including water, can damage the camera.

Check the back of the camera body and make sure it is lighttight. While the back of the camera is open, conduct a shutter speed test to determine whether the camera has maintained its calibration. You do this by opening the shutter at the varying speeds from one second to 1/1000" (or faster). There should be noticeable differences at the slower speeds (1/1", 1/2", 1/8", 1/15", 1/30" and 1/60"). Inspect the back of the outer film carriage of the camera for nicks and warps. Examine the door hinge for looseness.

### THE CAMERA OPTICS

Look through the viewfinder of the camera and focus on an object. If the field of view is blurred or obscured and you know your lens is in good condition, you may have a dirty viewfinder.

If the mirror is dirty, clean it carefully, using a blower brush. **Do not use lens-cleaning tissue or fluid on the mirror.** If smudges remain on the mirror, consult your supervisor before taking the camera body to an authorized dealer or repair shop for professional cleaning.

### OTHER IMPORTANT AREAS

Check the camera battery/internal light meter. A weak battery can affect your light meter reading, and ultimately, your photographs. Consult your instruction manual for further instructions.

Open the camera back and inspect the film chamber, rails, pressure plates, shutter curtain and take-up spool for dirt, film debris and other foreign matter. Use a blower brush to clean this area. Be careful not to press on the shutter curtain.

Inspect the neck strap for cracks and wear, especially at the pressure points (the clips that attach to the camera). In wet and humid climates, leather neck straps have a tendency to rot and should be checked daily.

Always store your camera in its case with the lens cap over the protective filter.

## **CAMERA ACCESSORIES**

*LEARNING OBJECTIVE: Identify the most common 35mm single-lens reflex camera accessories.*

The difficulty of choosing camera accessories is knowing what is required and what is optional. There are many accessories photographers use in their day-to-day work, but we will only mention a few to give you an idea of what they are.

Camera accessories may be considered as any photographic equipment (save a camera or lens) that is used with a camera or in picture making. Some of the more common accessories you should be familiar with include the following:

- Autowinders/motor drives
- Bulk film chamber
- Cable release
- Camera case
- Electronic flash
- Film holders
- Filters
- Lens and body caps
- Lens hoods

### **AUTOWINDERS/MOTOR DRIVES**

Autowinders and motor drives automatically wind-on or advance the film after each exposure. A motor drive will fire the shutter and advance the film for a preset number of exposures or work continuously. An autowinder simply advances the film after each exposure is made manually.

### **BULK FILM CHAMBER**

A bulk film chamber is a long-length roll film magazine designed to handle enough film for 250 or more exposures.

### **CABLE RELEASE**

A cable release is a device consisting of stiff wire encased in an outer flexible covering. It is used to trip a camera Shutter without touching the camera itself. One end screws into the camera shutter release; the other end has a thumb-operated plunger.

### **CAMERA CASE**

Several types of bags or cases are available for carrying your camera equipment. Some have a foam rubber lining that can be cut into the exact shapes of your equipment to protect and hold them firmly in place. Another type of case is called a gadget bag. It is usually made of leather or plastic and has either rigid or soft sides.

### **ELECTRONIC FLASH**

The electronic flash is a high-voltage light source for illuminating the scene to be photographed. It produces a momentary flash of high-intensity light.

### **FILM HOLDERS**

Film holders are lighttight containers for photographic film. They are used for positioning the film in the camera. Variations are called sheet film holders, film pack holders and roll film holders.

### **FILTERS**

Filters are optical elements, such as glass, gelatin or plastic, dyed in a specific manner to absorb light of certain colors selectively, to emphasize or subdue certain objects and to improve the monochrome or natural reproduction of objects.

### **LENS AND BODY CAPS**

Lens and body caps are protective covers that keep dust and moisture away from lenses and camera openings.

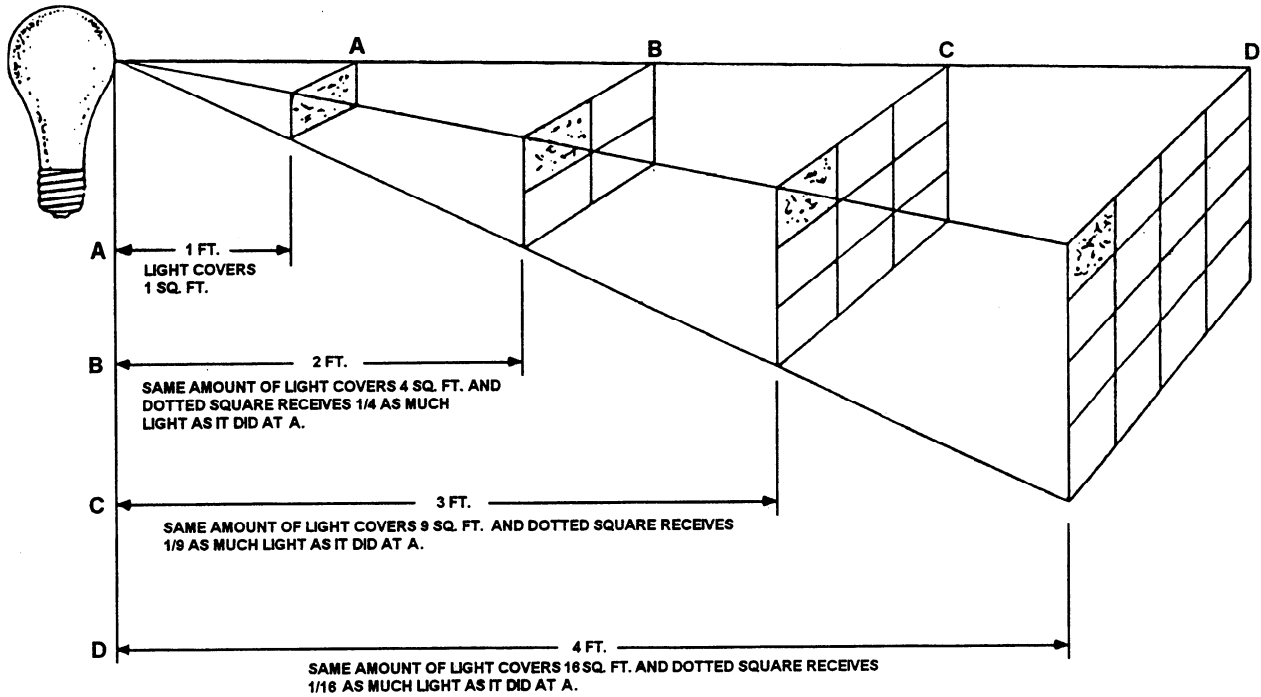

Figure 11-10.—Inverse-square law.

## LENS HOODS

Lens hoods, or shades, are used to keep strong sunlight from striking the front of the lens obliquely.

## PHOTOGRAPHIC LIGHTING

*LEARNING OBJECTIVE: Identify the basic theories of photographic lighting in terms of outdoor lighting, existing light and electronic flash lighting.*

Light is the most important ingredient in photography. Light makes photography possible by reflecting off the subject, entering the camera and exposing the film.

Scientists tell us that light is produced in waves. In many respects the waves of light can be compared to sound waves. Sound waves vary in length and they register as different pitches; conversely, light waves register as different colors.

The intensity of light determines the brightness of the subject. The formula that determines this is the inverse-square law (fig. 11- 10). It demonstrates that light decreases as the square of the distance increases. Becoming familiar with this law will help you use light more effectively during photographic assignments.

The light falling upon a subject from a source is titled **incident light**. When incident light strikes a surface, it will change direction; this change is called reflection. If the surface is smooth, the reflected light is said to be specular; however, if the surface is rough, the reflected light is diffused. Most objects reflect back both types of light.

Reflection is an important characteristic of light. It is how our eyes can see objects and how film acquires a latent image.

In this section you will learn how to take pictures using the following types of light:

- Outdoor
- Existing
- Electronic flash

## OUTDOOR LIGHTING

Daylight and sunlight are not constant sources — they change hourly with the weather, seasons and latitude. The changes in daylight can radically alter the apparent shapes, colors, tones and forms of a scene. The color of sunlight changes most rapidly at the extreme end of the day. Strong color changes also occur during storms, haze or mist and on blue wintry days. The

direction of the light changes as the sun moves across the sky. The shape and direction of shadows are altered, and the different directions of sunlight greatly affect the appearance of each scene.

The quality of sunlight depends on its strength and direction. Strong, direct sunlight is “hard” —it produces dark, well-defined shadows and brilliant highlights, with strong modeling of form. Sunlight is hardest on clear summer days at noon. Strong sunlight makes strong colors more brilliant, but weak colors pale. Sunlight is diffused by haze, mist and pollution in the air. This diffused or reflected light is softer; it produces weak soft shadows and dull highlights. Directionless, diffused sunlight is often called flat lighting. It produces fine detail but subdues or flattens form. In weak directionless sunlight, colors are muted — but strong, directionless, flat sunlight provides vibrant, well-saturated colors.

### Frontlighting

The old adage about keeping the sun at your back is a good place to continue our discussion of outdoor lighting. The type of lighting created when the sun is in back of the photographer is called frontlighting. This over-the-shoulder lighting was probably the first photographic advice you ever received. It may seem to be a universal recipe for good photography, but it is not. The case against over-the-shoulder lighting is that it produces a flattened effect, doing nothing to bring out the detail or to provide an impression of depth. The eyes see in three dimensions and will compensate for unhelpful lighting. However, a photograph is two-dimensional. To give an impression of f-, depth and texture to the subject, you should ideally have the light come from the side or at an angle (fig. 11-11)

### Sidelighting

As you gain experience with various types of outdoor lighting, you will discover that interesting effects can be achieved by changing the angle of the light falling on your subject. As you turn your subject, change camera viewpoint or wait for the sun to move, the light falls more on one side, and more shadows are cast on the opposite side of the subject. For pictures where rendering texture is important, sidelighting is ideal.

Look at a brick wall, first in direct front sunlight and then in sidelighting. Direct front sunlight will show the pattern of the bricks and mortar in a flat, uninformative way, but sidelighting will create shadows in every little

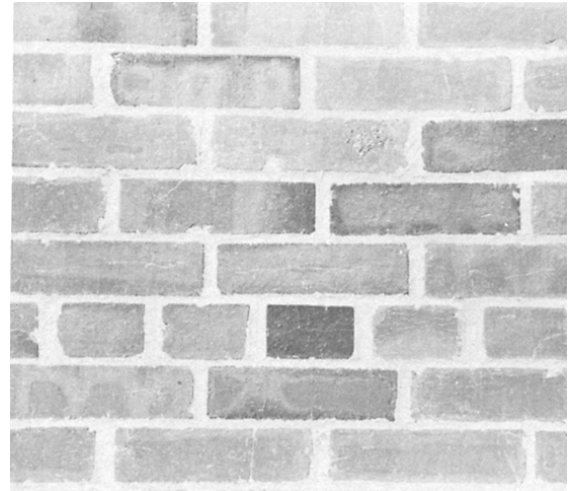

PHC Ronald W. Bayles  
302.89

**Figure 11-11.—Frontlighting.**

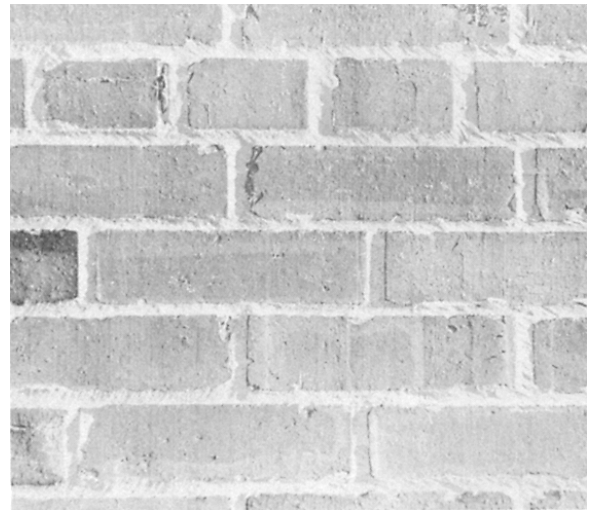

PHC Ronald W. Bayles  
302.89

**Figure 11-12.—Sidelighting.**

crevice (fig. 11-12). The effect increases as the light is more parallel with the wall until long shadows fall from the smallest irregularity in the brickwork. This can give an almost three-dimensional effect to a photograph.

Sidelighting is particularly important with black-and-white photography which relies on gray tones, rather than color, to record the subject. Shadows caused by sidelighting reveal details that can create striking pictures from ordinary objects that otherwise, hardly would be worth photographing in black and white. Anything that has a noticeable texture —like the ripples of sand on a beach, for example — gains impact





**Figure 11-13.—Backlighting without a reflector.**

when lighted from the side. Landscapes, buildings and people all look better when lighted from the side.

This principle also applies to color photography. Color gives the viewer extra information about the subject that may make up for a lack of texture in frontlighting, but often the result is much better when lighted from the side.

### **Backlighting**

When the sun is in front of the photographer, coming directly at the camera, you have what is referred to as backlighting (fig. 11-13); that is, the **subject** is backlit. This type of lighting can be very effective for pictures of people outdoors in bright sunlight. In bright sunlight, when subjects are frontlighted, or even sidelighted, they may be uncomfortable and squint. Backlighting helps eliminate this problem. Backlighting may require the use of a reflector or fill-in flash to brighten the dark shadows and improve subject detail (fig. 11-14). Backlighting also is used to produce a silhouette effect.

When you use backlighting, avoid allowing sun rays to fall directly on the lens (except for special effects). Use a lens hood or some other means of shading the lens to prevent lens flare.



**Figure 11-14.—Backlighting using a reflector.**

### **EXISTING LIGHT**

Existing light photography, sometimes called available or natural light photography, is the making of pictures by the light that happens to be on the scene. This includes light from table, floor and ceiling lights, neon signs, windows, skylights, candles, fireplaces, automobile headlights, and any other type of light that provides the natural lighting of a scene — except daylight outdoors (moonlight is considered existing light). Existing light is that type of light found in homes, in offices, in the hangar bay, in the chapel, in the club, in sports arenas, and so on. Outdoor scenes at twilight or after dark are also existing light situations.

Photography by existing light produces pictures that look natural. Even the most skillfully lighted flash picture may look artificial when compared to a good existing light photograph. With existing light photography, the photographer has an opportunity to make dramatic, creative pictures. Existing light allows the photographer greater freedom of movement because he is not burdened with extra lighting equipment. Subject distance, when not using flash, has no effect on exposure, so you can easily photograph distant subjects that could not otherwise be photographed using flash or some other means of auxiliary lighting. With existing

light you can make pictures that you could not make with other types of lighting.

For example, flash may not be appropriate during a change of command ceremony or chapel service. Not only might the flash disturb the proceedings, but it may not carry far enough to light the subject adequately.

### **Fluorescent Lighting**

Indoor scenes illuminated by fluorescent lights usually appear pleasing and natural in real life. However, color pictures of these same scenes will often have an overall color cast that makes them look very unnatural. Fluorescent light is deficient in red light and emits primarily blue and green light. Most color pictures made without a filter under fluorescent light also are deficient in red and have an overall greenish appearance. When it is used correctly, fluorescent light does have some advantages over other types of available light. A room illuminated by fluorescent lamps is usually brighter and more evenly lighted than a room illuminated by tungsten lamps. This higher level of light makes it easier to get enough exposure for your existing light photography and helps record detail that might have been lost in the shadow areas with other types of existing light.

When you are photographing people, fluorescent lighting often causes dark shadows under the eyes of the subject. This effect causes the eyes to appear dark and sunk in.

### **Nighttime, Outdoor Pictures**

Outdoor night scenes usually include large areas of darkness broken by smaller areas of light from buildings, signs and streetlights. Pictures of outdoor scenes are quite easy to make because good results are obtainable over a wide range of exposures. The use of short exposures emphasizes well-lighted areas by preserving the highlight detail, while the shadow areas become dark due to underexposure. Long exposures help retain the detail of the dark areas, while highlight detail is lost as a result of overexposure.

Large, dark areas in night scenes will make it difficult for you to make accurate exposure meter readings from your camera position. You will get the best meter reading results when you take closeup readings of important scene areas.

At night you can make color outdoor pictures using either daylight or tungsten-type films. Pictures made on daylight film will have a warm, yellow-red appearance.

Those made on tungsten film will have a colder more natural look. However, both films provide pleasing results so it is a matter of personal preference.

A good time for you to make outdoor night color pictures is just before it gets completely dark. At this time, some rich blue (or even orange) is in the sky. This deep color at dusk gives a dramatic background to your pictures. Neon signs, streetlights and building lights make bright subjects for your pictures.

### **ELECTRONIC FLASH LIGHTING**

In situations in which there is little or no light available, a portable, electronic flash unit is an invaluable piece of photographic equipment. With fast films and long exposures, you may be able to shoot existing light pictures — provided your subject remains still long enough. Although you can certainly get better lighting control with elaborate photographic lights, the simplicity and portability of electronic flash is unbeatable.

Electronic flash provides an excellent source of artificial light for exposing black-and-white and color daylight film. Light from an electronic flash unit (strobe) is characterized by its softness, short duration and color balance, approximating that of daylight.

When you measure the amount of light that actually reaches an object or scene, a numerical value is obtained that can be converted directly into a flash guide number. The numerical value is the light output rating of an electronic flash unit measured in beam candlepower-seconds (BCPS) or more correctly, effective candlepower-seconds (ECPS).

Every electronic flash unit is assigned a guide number as a measure of its light output or power. The higher the guide number, the greater the light output.

Correct exposure with electronic flash depends upon the following four factors:

- The power or light output of the flash unit
- The ISO speed of the film used
- The flash-to-subject distance
- The tistop used

Shutter speed is not a factor since the time of exposure is governed solely by the duration of the flash.

Notice we always speak of **flash-to-subject distance**, never camera-to-subject distances. With all types of artificial illumination (the same as with

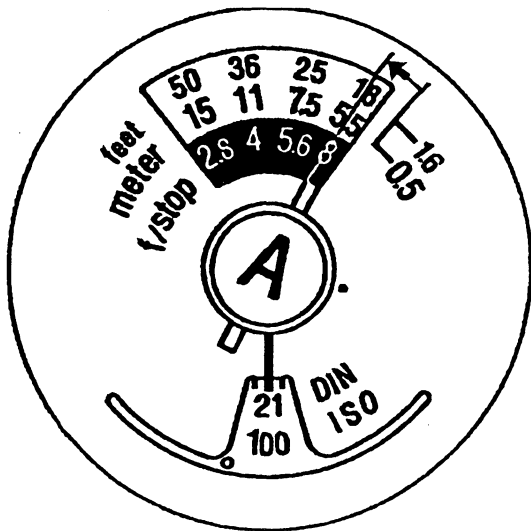

Figure 11-15.—Exposure scale on a flash unit (automatic mode).

sunlight), the only consideration is the amount of light reflected from the subject. The distance between the camera and the subject has no bearing on exposure. When the flash is used off the camera, the basic f/stop is still calculated with the flash-to-subject distance.

### Automatic Electronic Flash Units

Most electronic flash units can be operated in an automatic exposure mode. An automatic flash unit eliminates the need to determine the correct f/stop for each flash-to-subject distance, providing the subject is within the flash distance range of the flash.

On the front of an automatic flash unit, a sensor reads the light reflected from the subject that is produced by the flash. When this sensor is satisfied as to the amount of light received, it automatically shuts off the flash. The closer the subject is to the lamp, the quicker the sensor shuts off the light.

Some automatic electronic flash units allow you to select two or more apertures to control depth of field. To determine an f/stop in the automatic mode, you can use the calculator dial located on the unit. When you match the indicator to an ISO film speed number on the dial (fig. 11-15), the f/stop to be used within a minimum and maximum distance is indicated. Once an f/stop is selected and set, it is a constant factor regardless of the flash-to-subject distance, providing it is within the flash distance range of the unit. This feature allows a photographer to move closer to or further away from the subject without having to calculate an f/stop for each change of flash-to-subject distance.

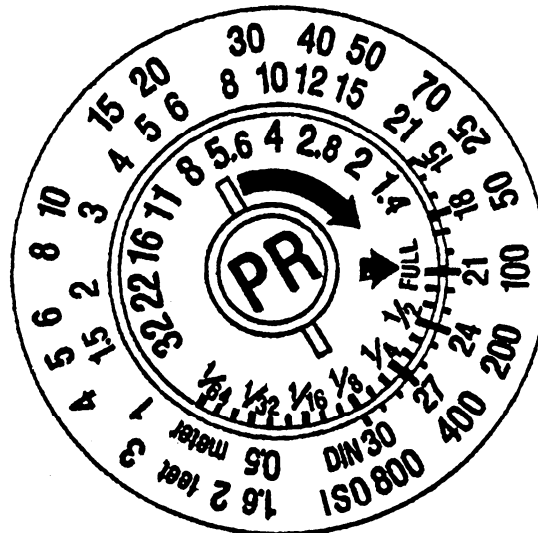

Figure 11-16.—Exposure scale on a flash unit (manual mode).

When the flash unit is in the manual mode, the f/stop must be changed every time the flash-to-subject distance changes. A scale on the flash unit (fig. 11-16) indicates the proper f/stop to use for the various distances. To determine the flash-to-subject distance for on-camera flash, focus on the subject and read the distance directly from the focusing ring on the camera.

### Single Flash

You will produce the majority of your indoor photographs with a single flash unit. Numerous reenlistments, frocking and promotion ceremonies are conducted indoors where the lighting conditions are unfavorable for available light photography. There are various methods in which a single flash can be used to produce high-quality professional photographs which distinguish you from the amateur snaphooter.

### On-Camera Flash

A flash technique commonly used is that of the flash unit attached to the camera, in synchronization with the shutter, and aimed directly at a subject. An advantage of having your flash unit attached to the camera is it gives you the chance to capture the unexpected — the truly candid shot. When spontaneity sparks the action and quick camera handling is a must, the fewer pieces of equipment you have to worry about or handle, the better. Rather than two pieces of gear (the camera and the flash), you have only one — the camera with the flash attached to it. However, this technique usually produces objectionable shadows behind the subject.

To help reduce the harshness of shadows, plain some diffusion material, such as a white handkerchief, cheesecloth, or frosted cellulose acetate, in front of the flash. Keep in mind that diffusion reduces the intensity of the light. Therefore, the exposure must be increased accordingly if you use the manual mode on the flash unit.

### **Off-Camera Flash**

You will make some of your best flash pictures with the flash unit off the camera. When you hold the flash off the camera and above the lens, it will tend to throw the shadows down and behind the subject. This is a good way to minimize distracting background shadows that occur when a subject is standing close to a wall. A flash held high above the lens, either left or right, makes the viewer less conscious of the flash illumination.

We are accustomed to seeing things lighted from above, and by placing the flash above the subject, it closely resembles the lighting of the sun or ceiling lights.

Light that is far enough off the camera to illuminate the subject from an angle produces modeling or roundness. This type of light creates the illusion of a third dimension — depth — and is more pleasing to the viewer than the two-dimensional flat effect you get with direct frontlighting. Angled lighting also is used to bring out the texture of a subject.

### **Bounce Flash**

One of the best methods to illuminate a subject or scene with a single flash unit is to use **bounce flash**. There will be times when you will want a very soft light in order to lessen the tonal range between highlights and shadows and to soften harsh background shadows. You can achieve this soft lighting by bouncing, or reflecting the flash off a light-colored surface. By doing so you are changing the narrow spot of light from a flash unit into a wide, diffused area of light.

Most bounce flash pictures are made with the light directed at the ceiling, either above the photographer or above the subject, or somewhere in between. You can produce a silhouette effect by bouncing the flash off the ceiling behind the subject. To accomplish this, aim your flash unit so most of the light bounced off the ceiling falls on the background behind the subject and calculate the exposure for the background.

For the flattest bounce light, try bouncing the light off a wall behind the camera. With this lighting you will have practically no shadows. Here you will have to

calculate your exposure based on the flash-to-wall-to-subject distance.

### **“RED-EYE”**

An effect that may appear with direct flash is “red-eye.” Red-eye occurs in pictures of people and animals when the flash is used close to the optical axis of the lens and the subject is looking at the camera. It is caused by light reflecting from the blood vessels at the back of the eye. The darker the room is, the stronger the effect will be because the pupils of the eyes will be dilated. Red-eye can be avoided easily by your moving the flash away from the lens optical axis. Also, you can minimize the effects of red-eye by turning up the room lights.

## **PHOTOGRAPHIC FILTERS**

*LEARNING OBJECTIVE: Identify the purpose of photographic filters, the various filter designations, and the filters used in black-and-white and color photography.*

Filters are used in all the various steps of the photographic process. Though often neglected in the shooting stage, the use of filters can tremendously enhance the final product in both black-and-white and color photography.

### **PURPOSE**

The purpose of photographic filters is to alter the characteristics of light that reaches the light-sensitive emulsion. As light is transmitted through a filter, at least one of the following alterations occurs:

- The color of light is modified.
- The amount of light is reduced.
- The vibration direction of the light rays is limited.

To use photographic filters properly, you must understand the nature of transmitted light.

White light is composed of three primary colors: red, green and blue. A filter of a primary color will transmit its own color and absorb the other two; for example, a red filter looks red because it transmits red and absorbs green and blue, as shown in figure 11-17.

Secondary colors are mixtures of primary colors. Yellow, for example, is a combination of red and green. Because a filter passes its own color and absorbs others,

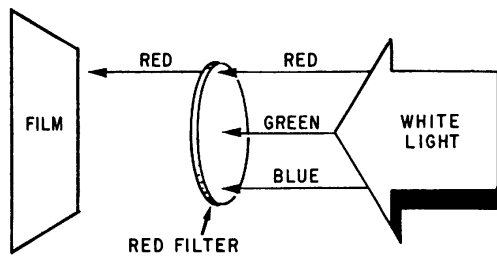

Figure 11-18.—Characteristics of a red photographic filter.

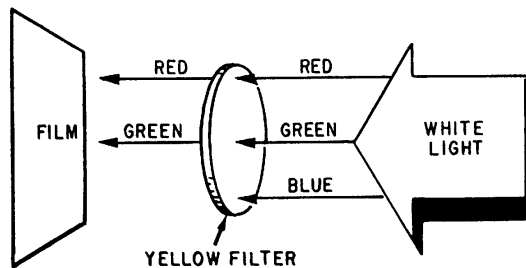

Figure 11-19.—Characteristics of a yellow photographic filter.

a yellow filter passes red and green and absorbs blue (fig. 11-18).

In selecting a filter in black and white photography, you can use the color star in figure 11-19 to determine the effect of the filter on the gray scale of the negative and the final print. On the final print, the result will be that a filter will lighten its own color and the colors adjacent to it and darken its complement and the colors adjacent to its complement; for example, a green filter will lighten green (its own color) and cyan and yellow (adjacent colors). It will darken magenta (its

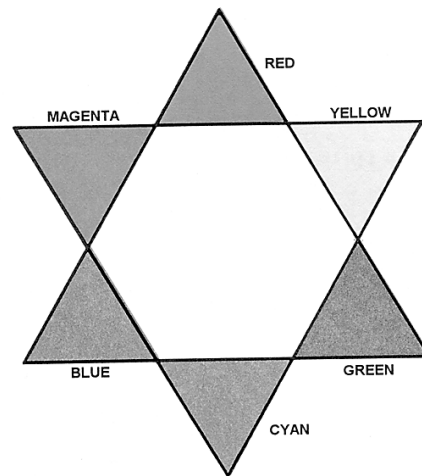

Figure 11-19.—Color star

complement) and blue and red (adjacent colors of the complement).

### FILTER DESIGNATIONS

Some filters are designated by a descriptive name, such as neutral density, haze, polarizing and skylight. Color compensating and color print filters have yet another designation system.

The Kodak Wratten™ filter line uses a numbering system to designate its black-and-white filters, as shown in table 11-1 that filters in the

Table 11-1.—Kodak Wratten™ Filter

Filter Color and Number	Filter Color and Number
Deep Red 29	Bluish Green 65
Red 25	Bluish Green 65
Light Red 23A	Cyan 44
Orange 21	Cyan 44
Deep Yellow 15	Blue 47
Yellow 8	Deep Blue 47B
Yellow-Green 11	Violet 34A
Yellow-Green 13	Violet 34A
Green 58	Magenta 33
Green 61	Magenta 33

first column lighten colors next to them, and opposite filters darken colors on the print. For example, a yellow-green No. 11 filter lightens subjects that are yellow-green or yellow and darkens subjects that are violet. A No. 44 cyan filter lightens blue and blue-green and darkens light red and orange.

## **USING FILTERS IN BLACK-AND-WHITE PHOTOGRAPHY**

Filters may be used in black and white photography for the following major reasons:

- To make the tones of gray in the final product conform more closely to the visual effects of colors in the original scene.
- To provide scenic contrast, such as darkening the sky so that clouds “stand out.” You can use a No. 15 or a No. 25 filter for this purpose.
- To lighten or darken a color to make it “disappear” or stand out in sharp contrast. An example of this could be photographing an old document that is written in blue ink and has yellowed with age. Here, a deep yellow filter would darken the blue writing, and at the same time, lighten and possibly remove the yellow stain.

Whenever you use a filter, you must change the exposure. The amount of change depends on the sensitivity of the film to the colors absorbed by the filter as well as the quantity of that color in the type of light used. The effects of the filter in terms of exposure correction are given on the film data sheet as a filter factor.

The filter factor may be applied to the exposure by opening the diagram one f/stop each time the filter factor is doubled. Thus a factor of two requires that the diagram be opened one f/stop larger than is needed for correct exposure without a filter; a factor of four call for two f/stops, a factor of eight for three f/stops, and so on.

An easy formula for determining exposure correction when you are using a filter is to divide the film speed by the filter factor and use the results as a corrected film speed on your exposure meter. As an example, when you use a black-and-white film with an ISO of 400 and a No. 11 filter (filter factor four), divide four into 400 and use the results, 100, as the film speed on the exposure meter. When using this method, make sure you return the meter dial to the correct film speed after using the filter.

## **FILTER FOR COLOR PHOTOGRAPHY**

Problems associated with color materials are quite different from those encountered with black-and-white materials. In color photography, the main problem is achieving correct color balance. The principal factor involved is the color temperature of the light source being used to illuminate the subject. This provides a natural appearance to the final product. Filters for color photography are classified as light balancing, conversion, and color compensating.

### **Light Balancing Filters**

Light balancing filters come in two series (not to be confused with a series that indicated physical size): the series 81 (yellowish filters) are used to lower the color temperature of light source, and the series 82 (bluish filters) are used to raised the color temperature of light from a light source. Both series are used when a tungsten light source is used with color film.

### **Conversion Filters**

Conversion filters are used in color photography when a significant adjustment of an exposing light is required to convert the color quality of the exposing light the color temperature for which a film is balanced.

Conversion filters generally come in two series. The 80 series of filters are blue in color and convert tungsten light to color qualities acceptable for use with daylight film. The 85 series are amber in color and convert daylight to color qualities acceptable for use with tungsten film.

The correct filter to use for a given situation with a given film can be determined by reading filter and film data sheets. If your are in doubt, seek help from your ship or base imaging facility.

### **Color Compensating Filters**

Color compensating (CC) filters are used to adjust the overall color balance obtained from color film, particularly slide film. Without the use of color compensating filters, improper color cast can result.

For cameras, CC filters are normally used to color balance the light from sources, such as fluorescent, tungsten, and mercury-vapor lights, and the “bounce” light reflected from colored surfaces. They are also used to balance lighting effects under unusual circumstances (such as underwater lighting). These filters can be used

to compensate for a known color deficiency of an unexposed color film. They also can be sandwiched (layered) when mounting a color transparency to compensate for an off-color hue.

## **SPECIAL-PURPOSE FILTERS**

Some of the special-purpose filters you will work with include the following:

- Neutral density
- Haze
- Polarizing
- Skylight

### **Neutral Density Filters**

Neutral density (ND) filters reduce the amount of light passing through a camera lens without changing the reproduction of colors in the scene. These filters are nonselective in their absorption of colors of light and therefore uniformly reduce the various colors of light in the spectrum. Thus white light and colored light are transmitted through a ND filter with only the **intensity** of the light being affected. These filters can be used with both black-and-white and color film.

ND filters are gray in appearance. These filters may be needed for pictures of a brilliant subject in bright sunlight. When you have set the fastest shutter speed and the smallest f/stop and still cannot take the picture without overexposing the film, you can use a ND filter to further reduce the exposure.

### **Haze Filters**

Suspended in the earth's atmosphere are minute particles of vapor and dust that cause a veil-like appearance called haze. This haze is most apparent in distant scenes. Haze is the result of sunlight being scattered by minute particles of matter that are present in the air. The amount of haze can vary due to atmospheric conditions. Haze should not be confused with mist, fog, smog, smoke or clouds. These conditions also can produce a veil-like appearance but filters have no effect.

When sunlight is scattered, green and red light also are scattered by the ever-present haze, but not nearly as much as ultraviolet radiation, violet and blue light.

Penetration of the haze is possible when filters are used to absorb scattered sunlight. A haze filter is any

filter that absorbs atmospherically scattered sunlight. This includes contrast and correction filters. When contrast and correction filters are used for haze penetration, they may be considered special-purpose filters. Although contrast filters can be used for cutting haze, these filters affect the gray tone rendering of colored objects. The contrast and correction filters that absorb the shorter wavelengths are the most effective. The recommended contrast and correction filter colors, in the order of greatest to least effective, for haze penetration are as follows:

- Red
- Orange
- Yellow
- Green

The use of an infrared sensitive black-and-white film with an infrared filter provides the greatest haze penetration of all.

### **Polarizing Filters**

Polarizing filters look like gray neutral density filters. However, their effect becomes apparent when you look at the blue sky through a polarizing filter while rotating it. As you rotate the filter, the sky appears to get darker, then lighter.

Polarizing filters are used in black-and-white and color photography for the following reasons:

- To reduce or eliminate unwanted reflections (glare) from nonmetallic surfaces, such as glass and water
- To effect exposure control (similar to ND filters)
- To reduce the effects of haze
- To darken the blue-sky image in both black-and-white and color photography
- To increase color saturation in a color photograph without altering the hues of image colors

There are a number of different polarizing filters. However, there are only two main types: one type fits over the camera lens, and the other is designed to be used over a light source. Since they do not affect color, polarizing filters and screens may be used for both black-and-white and color photography.

## Skylight Filter

A skylight filter adds warmth to a scene recorded on color transparency film by absorbing ultraviolet radiation. It does this by reducing the bluish cast prevalent in distant scenes and in scenes photographed on heavily overcast days or in open shade. A skylight filter is light pink in color.

## EXPOSURE CALCULATION

*LEARNING OBJECTIVE: Identify the components used to calculate a photographic exposure.*

When you click the shutter, a series of events occur inside the camera. The shutter opens and closes, and light passes through the lens of the camera onto the sensitized emulsion (film), forming a latent image. The emulsion will eventually yield a record of what the camera saw at the moment of exposure. This series of events will yield a satisfactory photograph, in a technical sense, only if the exposure was correct.

You must compute exposure to make sure that the amount of light reaching the sensitive emulsion is sufficient to record the image. Exposure depends on the sensitivity of the photographic emulsion to light and on the brightness reflected by the original subject. Because you usually desire to record the whole range of tones between the brightest and darkest parts of the original scene, you will have to adjust your exposure accordingly.

The same exposure can be given to a certain subject by using various combinations of lens openings and exposure times — a wide opening and short time of exposure may allow the same total amount of light to reach the photographic emulsion as a small opening and along exposure time. At the moment, your consideration of the other factors involved in exposure, such as image movement, depth of field and the use of filters, is unimportant. After you have decided upon the correct total exposure necessary for a given subject at a given time, you can modify the lens opening and shutter speeds later as you desire for specific results.

Incorrect exposures will ruin more of your photographs than any other technical error, yet accurate exposure is relatively simple. By reading and using the exposure guides contained in the film data accompanying your film, you can expect good results most of the time. However, accurate exposures using daylight or tungsten light sources can only be obtained by the correct use of an exposure meter.

An important factor for you to remember is that no light meter, camera, film or manufacturer can guarantee the correct exposures that good photography demands. The only guarantees are your awareness and practice of the exposure theory and practical meter techniques. Good exposure techniques are efficient and simple. Your having the knowledge of exposure techniques frees you from the stumbling block of exposure determination so you can concentrate on taking pictures, and it simplifies the subsequent developing and printing process.

## THEORY

The term *exposure*, while having different meanings at different times, is most often used by photographers to indicate a certain combination of shutter speed and lens aperture. In this case, the shutter speed denotes the length of time the shutter is “open,” allowing light to pass through the lens to strike the film.

As stated earlier, various combinations of lens aperture and shutter speed can yield the same exposure. The correct determination of camera exposure is the object of all exposure tables, charts, calculators and meters.

In any given photographic setting a variety of light will be reflected, since the brightness of various objects will reflect varying densities of light. Therefore, the exposure must be adjusted to produce the correct range of densities.

The result of exposure and development of film is very similar in many ways to that of rain falling on a light-colored concrete sidewalk. When the rain begins, only a few drops fall. The cement is darkened at only a few spots. As the rain continues, the cement becomes darker and darker, until it is uniformly wet and dark. Continued rain will then cease to cause any more changes in the color of the cement sidewalk.

You have experienced differences in the intensity of rain showers. At high intensities, much water comes down in a unit period of time, such as one minute. At low intensities, the amount of water is much smaller. As a result, you could get the same total amount of water within varying periods of time, according to the intensity of the rain. The total amount of rain recorded is equal to its intensity multiplied by the time during which it fell. The effects with light are very similar. Exposure is the amount of light falling on a unit area of the film or on a unit area of photographic paper. The intensity is the amount of light falling on this unit area during the exposure time. Thus the equation for exposure is as follows:

$$\text{Exposure} = \text{Intensity} \times \text{Time} \quad (E = I \times T)$$



Another similarity between light and rain on a sidewalk is in the blackening effect. With light the blackening (during development) increases with the exposure received by the sensitive film emulsion. The photographic lens and shutter assembly should be regarded as a device that controls the camera exposure received by the light-sensitive film emulsion inside the camera.

The aperture of the lens diaphragm controls the intensity of the light, and the shutter controls the time of exposure. Since a photographic reproduction of the original scene contains a range of tones of different brightness, a corresponding range of photographic exposure is given to the sensitized emulsion.

## **FILM LATITUDE**

A negative is said to be correctly exposed when it gives a satisfactory rendition of detail in both the deepest shadows and brightest highlights of the scene or subject. Fortunately, in many cases, there is more than a single exposure that will produce this result — there is a wide range of possible exposures within which satisfactory tone separation is possible. The “minimum” satisfactory exposure is one in which good tone separation is just attained in the deepest shadow areas. The “maximum” satisfactory exposure is one in which detail is just retained in the brightest highlight. Any additional exposure will cause this highlight detail to become flattened out or “blocked up.”

The range between these two exposures is known as latitude. This latitude may be narrow or wide, depending on the subject matter, lighting contrast, type of film and degree of development of the negative. In general, the black-and-white films you will be using have a greater margin for error than color films. Ignoring the influence of development for a moment, a softly lighted scene composed of objects that are, themselves, fairly uniform in tone will allow a wide range of possible exposures that will produce a satisfactory rendition on the negative. This is caused by the narrow range of tonal values from highlight to shadows in the subject. On the other hand, a brilliantly lighted scene composed of a variety of tones, from jet black to snow white, may take up the entire usable range of the negative scale. Therefore, the exposure required for the proper rendition of the entire range of tonal values in this scene may be quite critical.

In addition there are many scenes, such as interiors with sunlight coming through a window, that have a range of brightness so wide that no single exposure can produce both highlight and shadow detail in a black-and-white negative. When you increase exposure

and reduce the amount of development, almost any ordinary extreme of brightness range can be accommodated on black-and-white film.

## **FILM SPEED**

The sensitivity of black-and-white and color film for still-camera use is also called the film speed, the ISO speed or simply the ISO. Earlier in this chapter, we pointed out that “ISO” is an acronym for International Standards Organization, a federation of all national standard bodies of the world, which has approved a uniform set of film-speed standards. These standards call for a universal expression of both arithmetic and logarithmic values with the ISO designation.

Until early 1983 the emulsion speeds of still-camera film were expressed in ASA values (which are arithmetic) or in DIN values (which are logarithmic). ASA values were determined according to standards published by the American National Standards Institute, formerly American Standards Association from which the designation ASA came. The DIN values reflected the German standards established by the Deutsche Industrie Norm.

Film speed is determined by the manufacturer according to the ISO standards. It will generally look like this:

ISO 100/21°

The number immediately following “ISO” is the ASA equivalent. It indicates that the speeds progress arithmetically, and any film marked ISO 100 has the same sensitivity as any other film marked ISO 100 — it is twice as fast as film marked ISO 50 and is half as fast as film marked ISO 200. The number with the degree symbol (°) is the DIN equivalent.

The arithmetic speed number is intended for exposure meters or cameras marked for ISO or ASA speeds or exposure indexes. The logarithmic speed is intended for exposure meters or cameras marked for ISO or DIN settings.

## **FILM TYPES**

Photographic films (and papers) are composed of two basic parts: the emulsion and the base, or support. The emulsion is the light-sensitive portion of a film or paper that records the image. The emulsion contains the silver halides and any special sensitizing dyes suspended in a binder of gelatin. The gelatin holds the silver halides evenly dispersed and prevents action by a developer until the silver halides have been made developable either by exposure to light or chemical

action. The gelatin also acts as a sensitizer for the silver salts.

In photographic films and papers, the main purpose of the base is to support or hold the emulsion in place. Depending on how the recorded image is to be used, the base or support may be transparent or opaque. A transparent base is used for transparencies viewed by transmitted light and for negatives printed with transmitted light. An opaque base is used for prints that are viewed by reflected light.

The latest state of the art in light-sensitive materials used in photography is the use of the electronic medium. Still video disks do not contain an emulsion or a base. When video mediums are used, light is converted to electrical impulses, and these impulses are stored magnetically on a tape or disk. Since it is the camera itself that converts the light to electrical impulses, the recording medium and all stages of the photographic process can be carried out in normal room light.

### **Black-and-White Film**

The characteristics and use of black-and-white film depends largely on the actual construction of the emulsion. These characteristics include the following: the degree of sensitivity to light, response to various colors of light (color or spectral sensitivity), contrast, exposure latitude, emulsion latitude, and emulsion definition.

There are many types of black-and-white films available. Each differs from others in one or more characteristics. You should become acquainted with the characteristics of films. This knowledge is helpful in selecting the film most suitable for each photographic assignment.

### **Color Negative Film**

A color negative film records a scene in image densities opposite to the brightness of objects in the scene, the same as a black-and-white negative film. Color films can be recognized because they contain the suffix "color," such as Vericolor, Kodacolor and Fujicolor. These color films are used when a print is the final product. Most color negatives (except for color film used for aerial photography) has an orange mask incorporated in it. This orange mask increases the color separation which reproduces colors more accurately in the final print.

During development, colors that are complementary to the color in the original scene are formed in the emulsion. For example, a red object in the scene is recorded as cyan in the negative. A combination of

yellow, magenta, and cyan record all the other colors that we see in the scene. Color dyes in the emulsion layers control the colors of light passing through the color negative.

To produce color prints or color transparencies, you can print color negative film images on color positive materials such as color paper and color print film. Color negatives also can be printed on a special panchromatic black-and-white paper to produce black-and-white prints.

### **Amateur and Professional Color Films**

Much of the color film used in the Navy is manufactured by the Eastman Kodak Company. Kodak markets color films for both professional and amateur photographers. Color films intended for use primarily by professionals are identified by the word professional in the name — for example, Kodak Vericolor III Professional Film, Type S (VPS).

Both professional and amateur films have similar color quality, sharpness and granularity characteristics. They also have emulsions made up of many different chemicals that tend to change slowly with time. From the day they are made, all color films begin to change, and as the films age, their color balance changes.

Amateur films are manufactured to age and reach a peak color balance much later than professional films. The manufacturer allows for the time amateur film will be in storage, on the store shelf, and in the camera before it is developed. The ISO speed assigned is adequate for calculating exposure for normal picture-taking situations.

Professional films are manufactured so they are very near their optimum color balance at the time they are shipped from the factory. These films should be kept refrigerated or frozen until shortly before use. Refrigeration keeps the film near the optimum point until used and provides the photographer with confidence in consistent results. Precise film speeds are provided for professional films. The film is intended for prompt processing to prevent any significant shift in color balance after exposure.

### **MEASURING EXPOSURE**

The quantity of light can be measured in several ways. The most accurate method is the use of exposure meters. Photographic exposure meters are designed to be sensitive to light in the same manner as panchromatic film. Therefore, an exposure meter reading can be assumed to be valid under any visible lighting condition. Several types of hand-held meters are available. Some

measure incident light; some measure reflected light. Another line of light meters measure light only within the sensitivity range of the human eye.

However, for news photography and most other requirements of a Navy journalist, the built-in light meter described earlier in this chapter should more than satisfy your needs. This battery-powered meter, which measures reflected light, works automatically (unless you use the manual setting) to give you the correct exposure. When used manually, the built-in meter functions the same as a comparable hand-held meter and allows you to make whatever adjustments you prefer to achieve stylized or creative photographs. Except in cases involving special motion-picture film lighting and portrait studio work, the hand-held exposure meter has virtually been replaced by the built-in camera meter.

Before using any exposure meter, read the instruction book that comes with it to make sure that you use it correctly. The readings from an exposure meter, and the accuracy of the meter itself, are wholly dependent on the method used.

## CAMERA SETTINGS

When the photographer knows the sensitivity of the film and the amount of light available, the user determines the settings on the camera that will give the film a correct exposure. The settings are the f/stops and the shutter speed. Together, they control the total amount of light allowed through the camera to form the latent image on the film.

F/stops can range from f/1.4 (most amount of light) to f/22 (least amount of light). The f/stop system (factorial system) is always read as a whole number, not as a fraction or ratio.

Full stops in the English system of f/stops are as follows: 1.0, 1.4, 2.0, 2.8, 4.0, 5.6, 8, 11, 16, 22, 32, 45, 64, 90, and so on. Notice that the number doubles for each two-stop decrease in size. Slight optical confections are made for f/11 and f/45. This may seem confusing at first, but knowledge of the f/stop system is necessary to compute optical formulas used by advanced photographers. It is necessary to know that each marked f/stop on a lens, except its widest aperture, is usually a full stop — that is, it admits one-half or twice the amount of light as the adjacent stop, and the larger the number, the smaller the aperture. At first, it is perhaps easier to think of the f/stops in terms of fractions; 1/8 is larger than 1/11 which is, in turn, larger than 1/16.

Lens apertures can be set between marked f/stops. You could match information on the exposure calculation dial of an exposure meter. For example, if the light meter suggests an exposure of 1/125" at f/9.5,

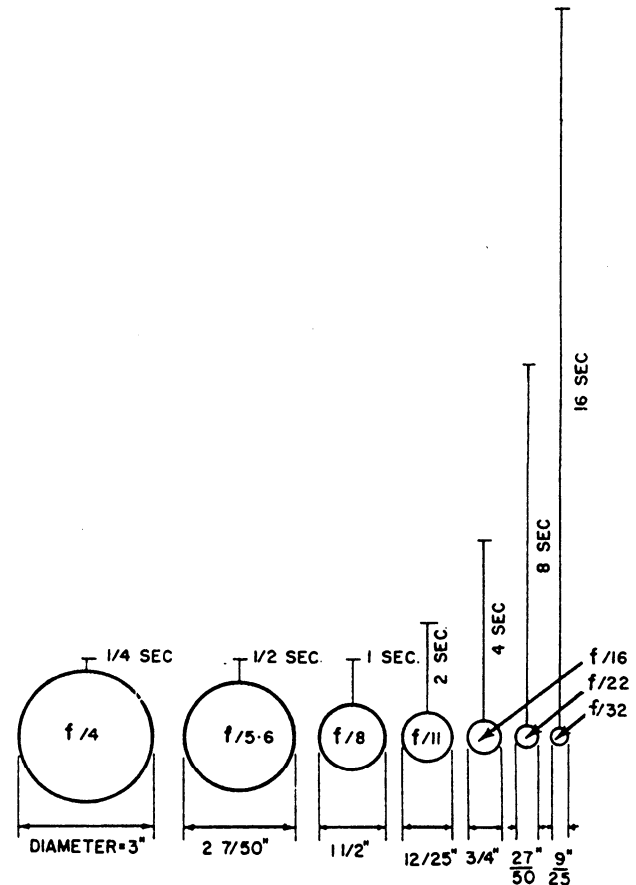

Figure 11-20.—Comparison between aperture, f/stop and relative exposure.

you could set the camera at 1/125" at f/8, allowing the film latitude to cover the difference, or at 1/125" with the lens aperture midway between f/8 and f/11, which would be more accurate (fig. 11-20).

Shutter speeds control the duration of time that light is allowed to pass through the lens aperture to the film. Shutter speeds are usually marked on the camera as the reciprocal of the fraction of a second that the shutter remains "open" (one is 1/1 or one second, two is 1/2 or one-half second, four is 1/4 or one-quarter second, and soon).

Standard shutter speeds are 1", 1/2", 1/4", 1/8", 1/15", 1/30", 1/60", 1/125", 1/250", 1/500", 1/1000" and 1/2000".

## f/Stop-Shutter Speed Combinations

With today's cameras offering you the opportunity to use automatic settings, you could just concern yourself with the f/stops of the camera and let the automatic shutter speed controls of the camera do the rest. However, should you choose to work with your

camera in manual mode, you must understand the relationship between the f/stop and shutter speed.

Shutter speeds are indicated so that each marked shutter speed admits one-half or two times the adjacent marked speed. Since both the lens aperture and shutter speed represent “full stop” changes in exposure, either can be moved as long as the other is moved a similar number of stops to compensate. A basic exposure of 1/125" at f/16 can be changed to 1/500" (two stops less light transmitted) at f/8 (two stops more light transmitted), and the result will be the same total amount of light transmitted to the film.

Shutter speeds cannot be set between marked “stops.” If an exposure is calculated to be 1/40" at f/8, using the closest shutter speed available on your camera, 1/30" or 1/60" will not result in an exposure error because of the exposure latitude of the film. An alternative is to set the shutter speed and an equivalent “half-stop” of lens aperture, such as 1/30" at f/9.5, or 1/60" at f/6.3.

With a selection of possible combinations, which should be used? Does it matter which is used? Why does the manufacturer put so many combinations on the camera?

Before these questions are answered, you must understand the correlation of lens apertures and shutter speeds. Think of the lens aperture as a water pipe (the larger the diameter of the pipe, the more the water can flow). Extending this further, think of the film sensitivity in terms of a bucket that has to be filled and the light intensity as the water pressure.

If a bucket can be filled in 1/30" with a pipe 8 square inches in area, how long would it take to fill using a pipe 4 square inches in area? Obviously, twice as long — 1/15". If the exposure is calculated at 1/30" at f/11, how long an exposure is required at f/16 (the aperture one-half the area of f/11)? The answer is 1/15".

What happens if the water pressure increases? It takes less time to fill the bucket. If we use a larger bucket (lower ISO film speed), it takes more water (exposure) to fill it.

## Shutter Speed Considerations

Generally, the shutter speed is chosen according to the amount the subject moves or how much of the movement you desire to show. If the subject moves slowly, a slower shutter speed can be used; if the subject moves rapidly, a faster shutter speed must be used to stop the movement and prevent blurring the image. Movement of the camera and photographer also must be considered. Therefore, the use of a tripod or similar brace is advisable when using a shutter speed slower

than the reciprocal of the lens focal length; for example, 50mm lens (1/60"), and 200mm lens (1/250").

To stop the movement or action in a picture, you must consider the following three factors:

- The relative movement of the subject
- The subject’s direction of movement
- The camera-to-subject distance

**THE RELATIVE MOVEMENT OF THE SUBJECT.**— The faster the movement, the faster the shutter speed required. The term *relative movement* is used because if the motion of the subject is followed, that is, the action is “panned” with the camera, a slower shutter speed can be used than if the camera were held stationary.

**THE SUBJECT’S DIRECTION OF MOVEMENT.**— A subject traveling at a right angle to the camera/lens axis requires a faster shutter speed than one traveling at a diagonal. Conversely, a subject moving toward or away from the camera, parallel to the lens axis, can be “stopped” with a slower shutter speed than movement in other directions (fig. 11-21).

**THE CAMERA-TO-SUBJECT DISTANCE.**— The closer the action is to the camera, the faster the shutter speed must be. A car traveling 60 miles per hour across the lens axis at a distance of 100 feet would be “stopped” by a shutter speed of 1/1000" (or perhaps 1/500"). However, if the camera-to-subject distance were increased to 500 feet, the action could be “stopped” with a shutter speed of “1/250" or” 1/125." If the car was a half mile away, 1/60" should be sufficient to stop the movement.

## DEPTH OF FIELD

Selection of a f/stop is done mainly for the desired depth of field. “Depth of field” is defined as the distance between the nearest and farthest points of acceptable sharp focus of the scene photographed (fig. 11-22).

Control of the depth of field is a valuable tool in photography. Depth-of-field charts are given in all camera instruction books as well as in photographic reference manuals, but many photographers fail to use them to their own advantage.

Simply stated, depth of field increases as the focal length of the lens decreases (a shorter focal-length lens is used), as the lens aperture decreases (gets smaller in size) and as the distance focused on (focal point) increases, or both. Inversely, depth of field is less for long-focal-length lenses than for short-focal-length

SUBJECT	DIRECTION		
	↑↓	↙↘	←→
Pedestrian (4 MPH)	1/60	1/125	1/125
Tractor (8 MPH)	1/125	1/250	1/250
Runner (12 MPH)	1/125	1/250	1/500
Sports, general (15 MPH)	1/250	1/500	1/1000
Horse, galloping (20 MPH)	1/250	1/500	1/1000
Automobile (35 MPH)	1/250	1/500	1/1000

Figure 11-21.—Slowest shutter speeds necessary to stop action.

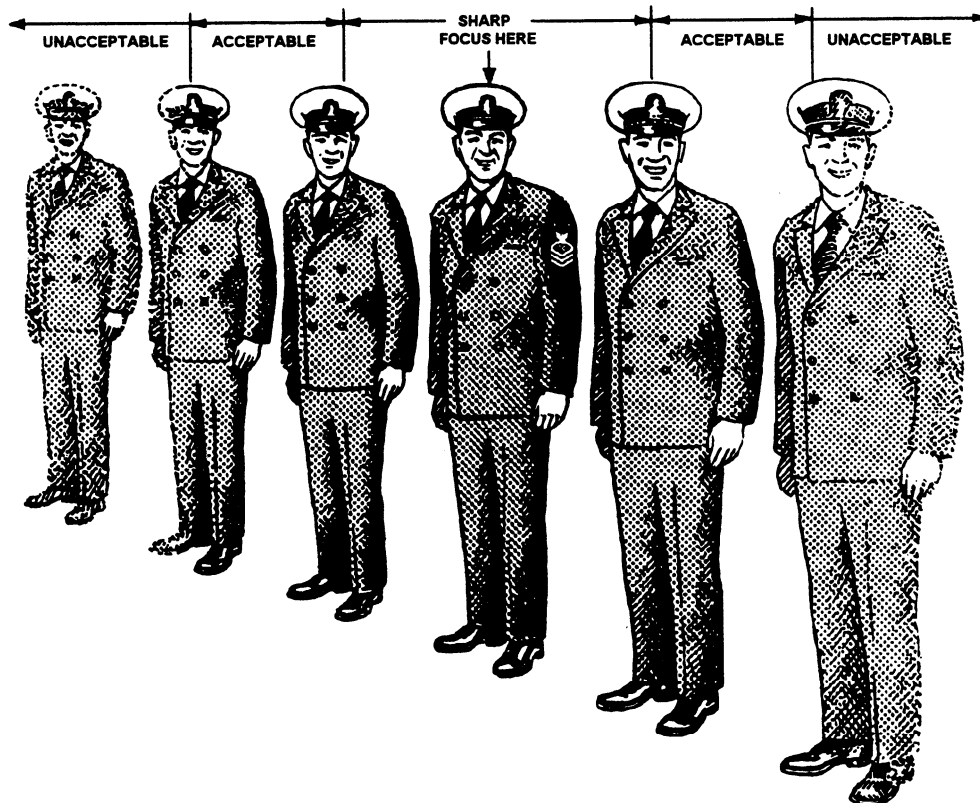

Figure 11-22.—Depth of field.

lenses, is less for wider apertures and is less for shorter lens-to-subject distances.

A peculiarity of the term *depth of field* is that it is usually used to define a condition of maximum depth of field; and when the depth of field is shallow or purposely restrictive, the term *selective focus* is used. Selective focus is merely “selecting” a depth of field that will satisfy a requirement to have the foreground, background, or both, not in sharp focus. The use of selective focus to make the main subject stand out in the picture by being “sharp” while the rest of the image area is blurred is a good technique for gaining subject emphasis.

The importance of proper focus and shutter speed cannot be overemphasized. Incorrect focus, subject movement, camera movement, improper use of depth of field, and so forth, can result in a blurred image on the photographic negative that cannot be connected in any way. Film latitude can take care of minor errors in the exposure, but there is no latitude for focus and stop action. An image is either in focus or out of focus; action is either stopped or blurred.

## DIRECTING PHOTOGRAPHIC SUBJECTS

*LEARNING OBJECTIVE: Detail the methods used in coordinating individual and group photographs.*

One of the most difficult tasks of photographing people is directing them. Since you are the only person who can see what the picture will look like before it is taken, you must take responsibility for “the.pose.”

### INDIVIDUAL PICTURES

As a Navy journalist you will take pictures of individuals for a multitude of projects, such as news releases, familygrams and cruisebooks. Therefore, you should be familiar with the methods used to direct photographic subjects.

One way to make directing and posing easier is to give your subject an object to handle. Do not tell him to “just stand there,” as though in a vacuum, with nothing to do. Men and women can hold a book binoculars or a tool used in their work. Children will do fine with a doll or model airplane.

Another strategy is to give your subject something to lean or sit on. Use a chair, stool, post or tree.

If you use props in your individual photographs, make sure you do your homework. For instance, do not

photograph a gunner’s mate holding a 3-inch shell in front of a 5-inch gun mount.

Eyes are very important when photographing people. When the subject’s eyes look straight into the camera, a strong and immediate impact is created that attracts the viewer’s interest. When the eyes are directed away from the camera, the effect is less explicit and has more of an ambiguous quality. Decide on the approach that is best for your photograph and direct your subject appropriately.

Finally, you must be in charge of the situation. It is up to you to tell the subject what to do, how to do it and when to do it. This applies to a vice admiral as well as a seaman.

Many people are nervous and self-conscious in front of a camera. They try to look their best, and in doing so often present a stilted expression or pose. It is your job to give directions regarding their pose. It is also your responsibility to make sure that coat sleeves are pulled down and wrinkles are smoothed out. Make sure the subject’s hat is set at the proper angle. If you ignore these potential problem areas, your photograph will ultimately suffer.

### GROUP PICTURES

Occasionally you will receive an assignment to photograph a group of people. There is added difficulty when working with a number of people at one time. You should consider each person individually, but you should also consider each individual as he relates to the entire group. Every precaution should be taken to make sure each person is shown clearly, and interest is not drawn to one person by some awkward pose or expression.

There are two general types of group pictures — formal and informal. Both are covered in the following text.

#### Formal

A formal group is one in which several people, uniformly dressed for the occasion, are seated or standing in as nearly the same pose as possible. Each member is placed in approximately the same relative position so that attention is not drawn to one person (fig. 11-23).

A formal group of about five people can be composed to fill the picture area very nicely. When six to 10 people are being photographed in a group, arrange them in two rows. For larger formal groups, arrange the people in as many rows as necessary to fill the frame



**Figure 11-23.—Formal group photograph.**

Avoid stringing out one long, narrow line of people across the frame.

When a large group is formed into three or more rows, you must devise some method to prevent the rear rows from being blocked from view. Furthermore, to compose the picture properly and fill it from top to bottom, you should have each row higher than the preceding one. One method is to arrange the group on the steps of a building, bleachers or terrace, so each row

is higher than the preceding one. On level ground the first row can be seated, the second standing, and the third standing on benches. Another method which you can use in combination with the first is to elevate the camera so that it is pointing down at an angle on the group. This method is useful as an aid in composing and filling the picture area. A higher camera angle can be useful in eliminating an undesirable background.

Customarily, in a formal group, the highest ranking person is located in the center of the first row and other members of the group arranged alternately to the right and left, according to grade. When all members of the group are the same grade, arrange them according to height, with tall individuals either in the center or at the ends, or occupying the rear rank.

### **Informal**

The informal group is intended to depict some action or tell a story about the individuals. Although the position and pose of each member is carefully planned, the results must appear casual and realistic (fig. 11-24). Members may be seated, kneeling or standing in a variety of positions and do not have to look in the same direction.

One of the most important factors in group photography is arranging people to obtain the best



**Figure 11-24.—Informal group photograph.**

PHAN K.M. O'Connell

possible composition. Regardless of the number of people in a group, they should be situated to fill the picture and provide the largest possible image size of each person. One exception to this general rule is when the importance of the background is equal to or greater than the group itself. This often occurs with an informal group when the picture is actually intended to emphasize some object or piece of equipment, rather than the individuals. In this case, locate the camera for the best composition of the Object; then arrange the people in the picture to enhance the story being told.

As with individual pictures, you must stay in charge. If you relinquish control, you will have a hard time getting everyone to look at the camera at the same time. Talk to the group and give them your instructions. Make sure your equipment is ready so you do not waste time and lose the group's attention.

## DARKROOM TECHNIQUES

*LEARNING OBJECTIVE: Recognize the basic techniques used in a darkroom in terms of using solutions and equipment.*

After a piece of photographic film or paper has been exposed to light, it is necessary to process the image and change it from a latent to a visible and permanent image. The process is chemical, and although you do not need to understand why the chemicals act as they do, it is important to know which chemicals/solutions are used, the order in which they are used, the recommended temperature and the required time.

“Photographic processing” can be defined simply as a series of chemical changes that accomplish the following goals:

- Develop the image
- Stop the action of development at a desired point
- Fix the visible image to make it permanent
- Wash away all traces of chemicals used
- Dry the photographic material

## PHOTOGRAPHIC SOLUTIONS

In the most basic processing, only two solutions are required: a developer and a fixer, plus water for washing. Additional solutions can be used as film conditioners to shorten processing time or to preserve other solutions. The solutions commonly found in

military imaging facilities, craft shops and even home labs are as follows:

- Developer
- Stop bath
- Fixer
- Wash
- Wetting agent

### Developer

When a photographic emulsion is exposed to light, the silver halides (usually silver bromide and/or silver chloride) in the emulsion change chemically. However, no noticeable change can be seen until the film is developed. The developer causes the affected silver halides to change into metallic silver while having no effect on the unexposed silver halides. The result is that a subject area reflecting the most light will affect the most silver halides and will be the darkest part of the image formed in development. That which is light in the subject is dark in the processed image and inversely, that which is dark in the subject is light in the image.

There are many types and brands of film and developer that all do the job they are designed to do. Reading and following the manufacturer's directions is the soundest advice that can be given. If the manufacturer states that a developer is for general use with film, do not expect good results trying to use it to develop prints. If the manufacturer states that the proper time to develop a certain film is 10 minutes at 70 degrees Fahrenheit (F), do not expect good results at five minutes or at 50 degrees F. If the manufacturer advises thoroughly dissolving Part “A” before adding Part “B,” mix the developer that way or be prepared to get inferior results.

### Stop Bath

It has become common practice to rinse film in running water after development to retard development and to remove excess chemicals. With prints, it is equally common to use an acid bath to stop the action of the developer and prolong the life of the fixer. In either case, the bath is referred to as a stop bath. Acetic acid diluted with water is the most commonly used stop bath.

### Fixer

The fixer is sometimes called “hype” because the main ingredient of the fixer formula, sodium thiosulfate, is also known as hyposulfate.



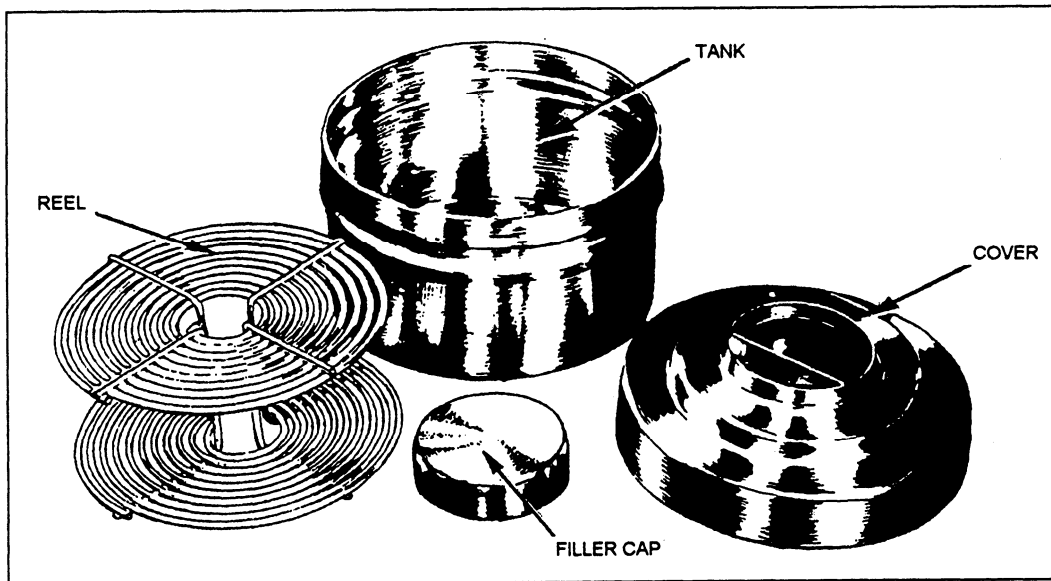

Figure 11-25.—Roll film processing tank and reel.

The purpose of the fixer is to convert the silver halides not changed to metallic silver in the developer into a soluble form. These soluble salts diffuse out of the emulsion and into the fixer. Navy imaging facilities use a recovery system to reclaim silver from chemically exhausted fixer.

Most fixer formulas include chemicals to harden the emulsion, which is greatly softened by the alkaline developer, and minimize scratching in later processing and handling. There are many types of fixers and many brands, as is the case with developers. All do their intended job if the manufacturer's directions are followed.

### Wash

Running water is not actually required but greatly simplifies the removal of all the chemicals previously used. The wash step is necessary if you desire a permanent image without stains. Wash films and papers with fresh running water for about five minutes.

### Wetting Agent

The wetting agent, usually called Photo-Flo, is a chemical designed to reduce the surface tension of water, thus reducing the possibility of water spots forming on film as it dries. It reduces the overall drying time of your films and prints — a point to consider especially on “rush jobs.”

### DARKROOM EQUIPMENT

The equipment required to process film can be minimal: a processing tank, graduate (measuring cup)

and thermometer. During processing, the film must be kept in total darkness until the image is fixed. Although there are other methods for accomplishing this, the simplest method is to use a lighttight stainless steel tank designed for the type and size of film being processed.

### TANK DEVELOPING ROLL FILM

*LEARNING OBJECTIVE: Identify the steps involved in developing roll film in a tank.*

It is more convenient to develop roll film in a small tank than in a tray. The results are usually better, and the possibilities of damage to the film are minimized. Additionally, after the film is loaded in the tank you can turn on the regular room lights and complete processing in normal room light.

Since the film must be loaded in total darkness, you should turn off all lights and allow your eyes to adjust for a few minutes before opening the film container. Examine the room for light leaks (cracks in walls, around doors, around air conditioners or vents). If you can see what you are doing after a few minutes, there is too much light in the room and the condition must be corrected before opening the film cassette.

The most common unit used to develop roll film consists of a stainless steel, center feed, spiraled reel to hold the film; a tank with a lighttight cover; and a filler cap. The construction of tanks and reels differ somewhat among the various manufacturers' models, resulting in differences in loading and use. However, the one you are most likely to use is shown in figure 11-25, and the following discussion will be based on this equipment.

Now that you know what the chemical solutions will do, just follow these steps for processing your film.

## ASSEMBLE MATERIALS

Assemble your materials before turning off the lights. Searching for equipment in the dark can be nerve racking. Typical developing equipment for 35mm film includes the tank, can opener, timer, graduate(s), thermometer, scissors and film clip(s). Keep these materials in a handy location, but away from the area immediate in front of you. This will prevent you from bumping into them or confusing them with other material.

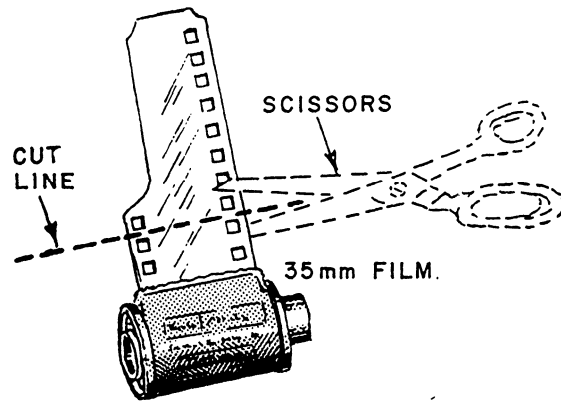

Figure 11-26.—Cutting leader (loading tab) from 35mm film.

## ADJUST WATER TEMPERATURE

Adjust the tap water until a steady temperature of between 65° to 75° F is maintained. Dilute the film developer in a graduate and place it in a tray with the other chemical bottles. Let water run in the tray and wait for the temperature to stabilize, usually in two to three minutes.

## FILM REEL LOADING

The proper loading of the film reel **in total darkness** can be the most challenging steps in processing roll film. A good amount of repetition is required to load film successfully. Practice loading several dummy rolls in both white light and total darkness before you turn off the lights and load actual exposed film.

**NOTE:** Handle the film only by the edges to prevent scratches and fingerprints!

Use the following steps to load the film on the reel:

1. If you are right-handed, position the ends of the wire spiral reel on the top and pointing to the right. If you are left-handed, position the ends on top and pointing to the left.

2. Pick up the film cassette. If a short length of film is left protruding from the 35mm cassette when the film is rewound, you do not have to open the cassette to remove the film. The leader or loading tab on 35mm film can be cut off square (in the light, if you desire) to ease loading, as shown in figure 11-26. However, if the leader is enclosed within the cassette, remove the flat bottom of the cassette with a can opener, as shown in figure 11-27; then cut off the leader as previously described.

3. Bow the film slightly concave to clear the edges of the spiral and clip or hold the film to the core (center)

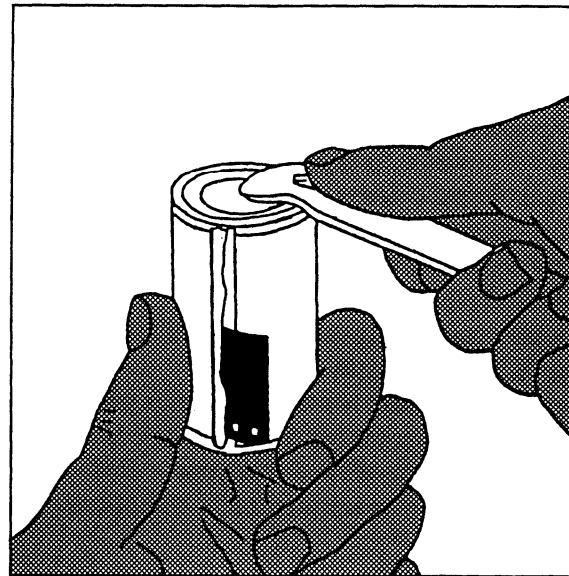
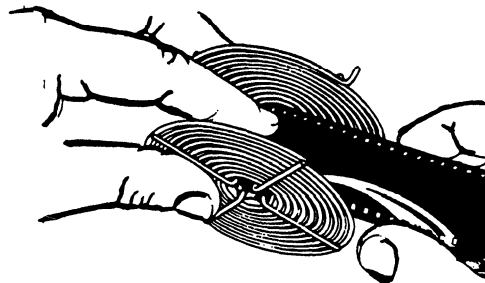

Figure 11-27.—Opening a 35mm film cassette with a can opener.

of the reel. The film emulsion must face in, or toward, the center of the reel. The tension on the film should be firm enough to prevent the film from skipping the spiral grooves, but not too firm to cause it to overlap or fall into the same groove twice.

4. Turn the reel while applying a gentle pressure. This pressure will produce a slight curl in the film and allow it to pass into the edges of the reel. **Make sure you keep your thumb and forefinger on the film edges!** As you continue to turn the reel, the film will straighten out and fit into the grooved spaces in the reel. Figure 11-28 shows the proper way to load 35mm film on a wire reel.

**HOLD THE REEL SO THAT ITS GROOVES RUN IN THE SAME DIRECTION AS THE FILM. IN DARKNESS OPEN THE FILM CONTAINER AND ATTACH THE END OF THE FILM TO THE REEL CLIP SO THAT IT FEEDS IN STRAIGHT AND PARALLEL TO THE GROOVES.**



**BOW THE FILM BY GENTLY PRESSING ITS EDGES, SO THAT IT FEEDS SMOOTHLY ONTO THE REEL; BE CAREFUL TO AVOID SHARP KINKING.**

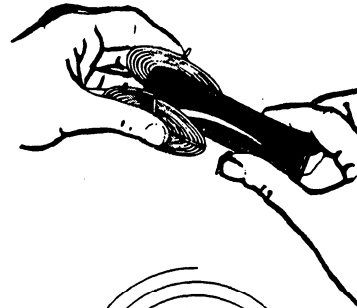

**KEEPING THE FILM BOWED, ROTATE THE REEL WITH YOUR OTHER HAND, MAKING SURE THAT THE FILM DOES NOT TOUCH ITSELF. THE FILM SHOULD BE DRAWN INTO THE SPIRAL CHANNEL. IF IT JAMS OR FEELS BUCKLED, UNWIND A TURN OR SO AND TRY AGAIN.**

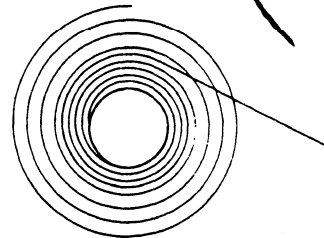

**AT THE END OF THE FILM, CUT OR TEAR OFF THE SPOOL AND TUCK IN THE END OF THE FILM. RUN YOUR FINGERS AROUND THE OUTSIDE OF THE REEL TO FEEL IF THE FILM HAS BUCKLED DURING LOADING. IF ANY PART OF THE FILM IS PROTRUDING, THEN IT SHOULD BE UNWOUND AND RELOADED.**

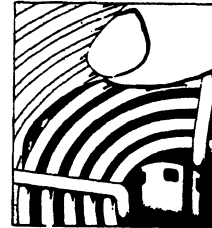

Figure 11-28.—Loading 35mm film on a wire reel.

## DEVELOPING THE FILM

After you properly load the film on the reel, you are ready to begin the actual chemical process of film development.

The following are the steps used to process roll film in small tanks:

1. Place the loaded reels into the tank. If the loaded reels do not come to the top of the tank, add empty reels to take up the space. Place the cover and cap on the tank. The lights may now be turned back on. Once the lights are on and before the film is fixed, be careful

not to remove the tank cover or the film will be exposed to light and ruined.

2. Hold the tank in one hand and tilt it slightly; pour the developer directly from the graduate into the tank through the light trap pouring hole. As the developer nears the top of the tank, hold the tank level or set it in the sink. Fill the tank to just overflowing. This step should take about 10 to 20 seconds, depending on the tank size.

3. Immediately start the timer once the tank is full. Replace the cap and strike the tank on the edge of the sink once or twice to dislodge any air bubbles. Now agitate the film by inverting the tank slowly end to end

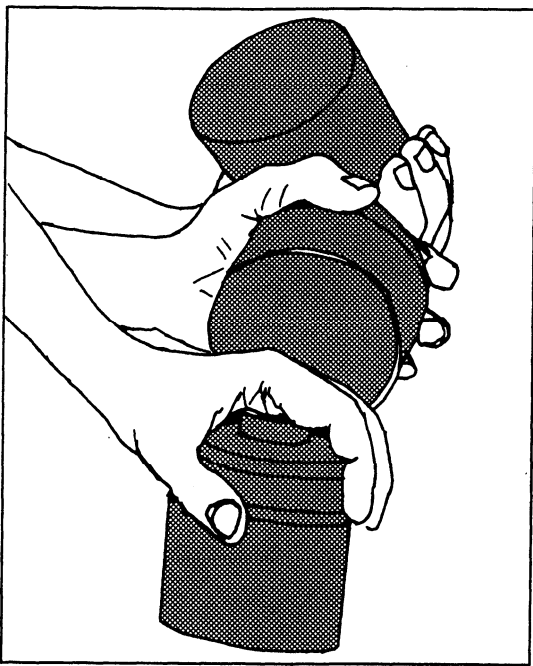

Figure 11-29.—Agitating a small developing tank.

(fig. 11-29). The initial agitation should be 30 seconds. Place the tank in the sink on its bottom (cover up).

4. Once every minute, agitate the film for five seconds by slowly inverting the tank end to end. After each agitation cycle, place the tank back in the sink. If the tank is held during the entire developing period, the heat from your hands may heat the developer and produce unpredictable results.

5. When only 10 seconds of developing time remain, remove the **cap** from the tank cover. Immediately start pouring the developer out of the tank through the light trap pouring hole. **Dispose of the chemicals according to the local instructions of your imaging facility.** This step should take about 10 seconds to complete.

6. When the developer has been emptied from the tank, fill the tank to overflowing with stop bath. The stop bath must be poured into the tank through the light trap pouring hole in the tank cover. Replace the cover cap. Agitate the film in the stop bath for about 30 seconds, using the end-to-end method.

7. When the stop bath portion of the process is complete, pour the stop bath through the light trap hole in the tank cover.

8. With the tank cover still in place, pour fixer into the tank and replace the cap. Dislodge air bubbles and set the timer to the required fixing time. Start the timer

and agitate the film, using the same agitation as the developer.

9. When the prescribed fixing time has elapsed, remove the tank cover and pour the fixer from the tank back into the bottle from which it came. Never pour the fixer into the sink. The fixer can be reused and then saved for silver recovery.

10. The film can be washed either in the tank or in a roll film washer. If the tank is used, insert a hose down through the center of the reels until it is about one-half inch from the bottom of the tank. Adjust the water (at the same temperature the film was processed) so a steady overflow is created. Wash the film for about 20 minutes.

11. While the film is washing, rinse the processing tank, tank cover and cap with clean water. Fill the tank with water (check the temperature) and add the wetting agent. After the film has been washed, place the film, still on the reels, into the wetting agent solution. Replace the tank cover and cap and agitate the film in the wetting solution **very slowly** for one minute.

12. After one minute in the wetting solution, remove the loaded film reels from the tank (Do not save the wetting solution.)

13. To dry the film, attach the end of the film to a clip in the drying cabinet (fig. 11-30). Let the film unwind from the reel as you slowly lower the reel.

When the film is unwound, depress the grip clip (if the reel has one) or remove the film from the core of the reel. Squeegee the film and attach a second film clip to the lower end of the film. Close the drying cabinet door and dry the film.

## CLEANING UP

After processing, the darkroom and all equipment must be cleaned up immediately. Rinse thoroughly all processing equipment: tanks, reels, thermometers, funnels, and soon, in clean, warm water. Place the clean equipment where it can dry before it is needed for the next processing project. Always leave the darkroom spotlessly clean and in good order.

## CONTACT PRINTING

*LEARNING OBJECTIVE: Recognize the purpose of contact printing, identify the required contact printing equipment, and determine the procedure used in contact printing.*

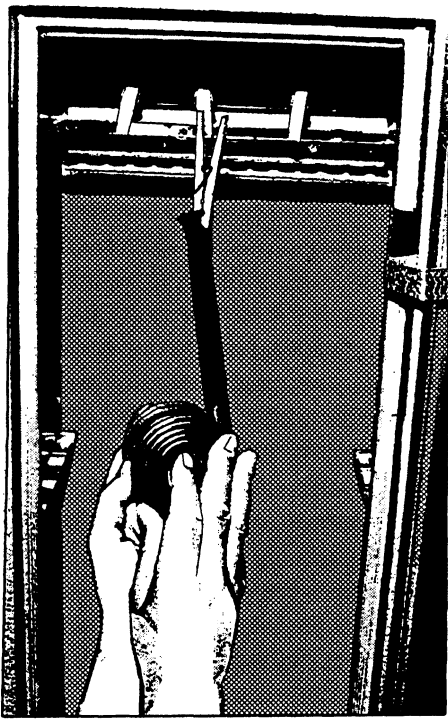

Figure 11-30.—Drying film in a drying cabinet

In Photography, *printing* is the term used to describe the process of making positive images from negatives (and, in some instances, from film positives). The most familiar example is the print made on a paper base. A photographic print is made by passing light through the negative onto a piece of paper that is coated with a light-sensitive emulsion very similar to film.

A contact print is produced by exposing a sheet of photographic printing paper through a negative with the paper emulsion and the emulsion side of the negative in contact with each other. Light is directed through the negative that controls the amount of light transmitted to the paper. The dense areas of the negative pass less light than do the more clear or less dense areas. The image densities formed (after development) in the emulsion of the paper make a positive print that represents the tonal values of the original subject. Furthermore, since the paper is in direct contact with the negative, the print produced is exactly the same image size as the negative.

## CONTACT PRINTERS

Contact printing is the quickest, simplest, and most economical method of producing photographic prints. For making proof prints and small volume printing, all you need for a “contact printer” is a sheet of glass, a light source, and some sort of padding.

For making contact proof prints and the occasional contact print job, a glass and a supporting pad are all that are necessary. “Contact printers,” consisting of a sheet of glass hinged to a metal frame and a pad assembly, are generally known as proof printers. If such a device is not available or is not large enough for the negatives to be contact printed, a piece of 1/4-inch plate glass and a soft padding (such as a rubber typewriter pad) can be used. Quarter-inch plate glass is heavy enough to keep the negatives and paper flat and in contact during exposure. The glass must be free of flaws, scratches, bubbles and dirt.

## CONTACT PRINTING PROCEDURE

Check the lamp to be sure it is operating properly. Rinse the trays with fresh water, and prepare the developer, stop bath and fixing solutions. The trays should be larger than the prints to be produced, and one of the largest or deepest trays available should be used for the fixing bath.

When the solutions are ready, rinse and dry your hands. A supply of printing paper should be available and conveniently near the printer. Place an empty paper box or paper safe near the printer if the prints are not to be processed after each is exposed. Hold the paper in these until the paper is ready to be processed. If the paper is not stored in a paper box or paper safe, it will fog eventually, even under safelight conditions.

## Examining the Negative

The first requirement in making a good print is a clean negative. The negative must then be examined to determine the contrast (flat, normal or contrasty) and the approximate exposure time required to produce a quality print. As a novice darkroom worker, you may not be able to make these determinations accurately. However, in a short time, and with a little experience, you will not have any trouble.

## Selecting a Printing Filter

Your imaging facility should have a contrast printing filter kit consisting of seven filters in half-step increments from one to four. The number two filter is normal contrast; any filter lower than two decreases the contrast. A filter higher than two increases contrast.

In analyzing a negative to determine the most suitable printing filter, be careful not to confuse contrast with density. When in doubt, it is best to make test prints. If the test print is contrasty, another test print should be

made with a lower numbered filter that will lower the contrast. If the original test print does not have enough contrast, change to a filter with a higher number to increase the contrast.

## **Making a Test Print**

The printing exposure is the operation most likely to cause you trouble. Unlike most films that can tolerate some overexposure and underexposure and still yield usable photographs, printing papers must be exposed correctly to produce good prints.

Experience and familiarity with printing equipment does help, but for the beginner, the correct exposure for prints from most negatives is best determined by making test prints.

The density of a negative is a variable you must consider. Negative density can be determined by making a few test exposures. The exposure time for a negative of average density may be about one to three seconds. If the negative is large, avoid the expensive and wasteful temptation of using a whole sheet of paper. Instead, use a strip about 2 inches wide and as long as the negative for the test exposure. For example, an 8- x 10-inch sheet of paper can be cut into three or four small strips.

After you have determined the filter and the test exposure time, set the timer for the estimated test exposure time. Place the paper test strip over the negative in the printing position. Place the test strip on the negative so the test exposure includes some highlights, midtones and shadow areas. Hold the paper in position with one hand and lower the platen into the printing position. As soon as the platen grips the edge of the paper, move your hand out of the way. When the platen is fully lowered, turn on the printing lights for the test exposure time.

When the test strip has been exposed, develop it for the recommended time. If the image is too dark the exposure was too long. If the image is too light, the exposure was too short.

It is difficult for even an experienced photographer to judge the contrast of a print that has been under- or overexposed. If the test print is too light or too dark the exposure should be changed until the proper density is reached with normal development before you attempt to judge the contrast of the print. A normally exposed print develops gradually, but steadily — shadows first, then midtones, and finally highlights. The image should appear in about 30 seconds, providing that the developer is at the proper strength and temperature. If the image

develops very quickly with a general mottling, it was overexposed and the next test should be given less exposure.

When you have produced a satisfactory test print, you can make your production prints from that negative.

If you use a printing frame (glass and pad or proof printer) to make contact prints, the most convenient and economical way to determine exposure and connect contrast is to expose the test strip in progressive steps of, for example, two, four, six and eight seconds. This is done by holding an opaque card on top of the glass and covering three quarters of the paper and exposing one-quarter of the paper for two seconds. The card is then moved to cover one-half of the paper and giving it an additional exposure of two seconds. Move the card so it covers one-quarter of the paper and give it another two seconds of exposure. Finally, remove the card and give the entire sheet one last exposure of two seconds. This will show a distinct progression of exposures of two, four, six and eight seconds (fig. 11-31). Develop the test strip normally and determine the correct exposure by visual examination in white light.

If the correct exposure appears to be between two steps, the required exposure can usually be estimated with some accuracy. However, further test prints maybe needed.

## **Exposing and Processing Prints**

When a test print develops in the recommended time, rinse it in the stop bath, immerse it in the fixing bath for about 30 seconds, rinse it in fresh water, and inspect it carefully under white light. If the density and contrast of the image look correct under white light, make your first “straight print.”

Place the sheet of printing paper, emulsion-side down, over the negative in the printing position by aligning the paper edges with the paper stops on the mask (if a mask is used). Hold the paper in the printing position with one hand to keep it from slipping out of place when the platen first presses against the edge of the paper, and start the printing cycle as described before. After the printing cycle is completed, remove the paper for processing. Any number of duplicate prints can be made by repeating the printing cycle.

Drop the print, emulsion-side down, into the developer. Immerse it immediately with a quick sliding motion while pushing it under the surface of the solution. Grasp one edge of the print, lift it up, and turn it over. Replace the print, emulsion up, on the surface of



PH2 Noel R. Guest  
165.2

**Figure 11-31.—A processed test strip.**

the solution; push it under the surface again and leave it under during the remaining time in the developing tray. The print must be immersed rapidly and evenly to prevent the formation of air bubbles on the emulsion surface. Be sure that all the emulsion gets wet with developer in the shortest time. Agitate constantly for the remaining developing time.

Each type of printing paper has its own working characteristic, differing mainly in the length of time required to develop the image in a given type and strength of developer. A correct print is one that develops to the proper density and contrast in the recommended time.

When the print is fully developed, lift it out of the developer, drain it momentarily, and place it in the stop bath.

After about five seconds in the stop bath, lift the print, drain it briefly, and place it in the fixing bath. Agitate it in the fixing bath for a few seconds and examine it for any defects that might cause it to be discarded. When the inspection is completed, place it, emulsion down, in the fixer and complete the fixing process. Use the manufacturer's recommended fixing time.

Some papers have a tendency to float in the fixing bath, especially if the bath is mixed a little stronger than usual. When prints float in the fixer, they should be handled constantly, or turned facedown to prevent the emulsion from being exposed to the air. The parts of a print exposed to the air during fixing may become stained.

## CAUTION

Never attempt to work backwards through the sink-line process. A few drops of fixer on your hands or from a print will contaminate the developer.

## PROJECTION PRINTING

*LEARNING OBJECTIVE: Recognize the purpose of projection printing, identify the main difference between projection and contact printing, and summarize the advantages of projection printing.*

Projection printing is the process of making positive prints by projecting the negative image onto photosensitive paper. The projected image may be enlarged, the same size as the negative image, or reduced in size. When the print images are larger than the negative images, the process is called enlarging. When the print images are smaller than the negative images, the process is called reducing. Because projection printing is usually used to make positive prints with images larger than the negative, projection printers are usually referred to as enlargers. The term *enlarging* generally refers to all forms of projection printing.

## DIFFERENCES BETWEEN PROJECTION AND CONTACT PRINTING

Projection printing differs from contact printing because the negative is separated from the paper and the image is projected by a lens onto the sensitized material. The negative is placed between an enclosed light source and a lens. The lens receives the light that passed through the negative and projects the image onto the paper. Changing the distance between the lens and the paper controls the size of the image. The image is focused on the paper by adjusting the distance between the negative and the lens. It is possible to enlarge or reduce the size of the projected image by changing and adjusting these distances.

Enlarging is a very adaptable and versatile process because considerable image and exposure control can be used. The main advantage of enlarging over contact printing is that large prints can be made, but there are several other important advantages. The advantages of projection printing areas follows:

- **Cropping (selecting the main area of interest in a negative) can be done and enlarged to any**

**suitable size.** This gives you the opportunity to eliminate unwanted and distracting elements from around the point of interest of the picture.

- **Dodging or burning in.** This allows you to apply local exposure control to bring out more detail in the highlight and shadow areas.
- **Local fogging with a small external light, such as a penlight, to darken selected areas.** For example, to darken the background of a portrait to direct viewer attention to the face.
- **Special effects.** You can change the appearance of the image by use of diffusers or patterns between the lens and paper.
- **Image distortion correction or introduction can be done by tilting the enlarger easel.** An easel is the device used to hold the paper during exposure.

## ENLARGERS

In general, all enlargers are similar in design and operation. They have an enclosed light source, some method of providing an even distribution of light over the negative, a negative carrier, a lens, and a means of adjusting the lens-to-negative and lens-to-paper distances. There are two types of enlargers —condenser and diffusion.

### Condenser Enlarger

The condenser enlarger (fig. 11-32) is the one most commonly used in Navy imaging facilities. It has a set of condensing lenses between the printing light and the negative. These lenses align and project the light rays evenly through the negative. Since all features of the negative are being enlarged, any flaws also will be enlarged.

### Diffusion Enlarger

The diffusion enlarger (fig. 11-33) has a diffusing medium (usually a ground glass) between the light source and the negative to spread the light evenly over the entire surface of the negative. Light emitted from the lamp, as well as that reflected from the parabolic reflector, strikes the diffuser, which, in turn, scatters it in all directions. Thus, when the light reaches the negative, it is traveling in a nondirectional pattern.

Most enlargers have a tungsten lamp as a light source. The lamp is enclosed in a lighttight housing that



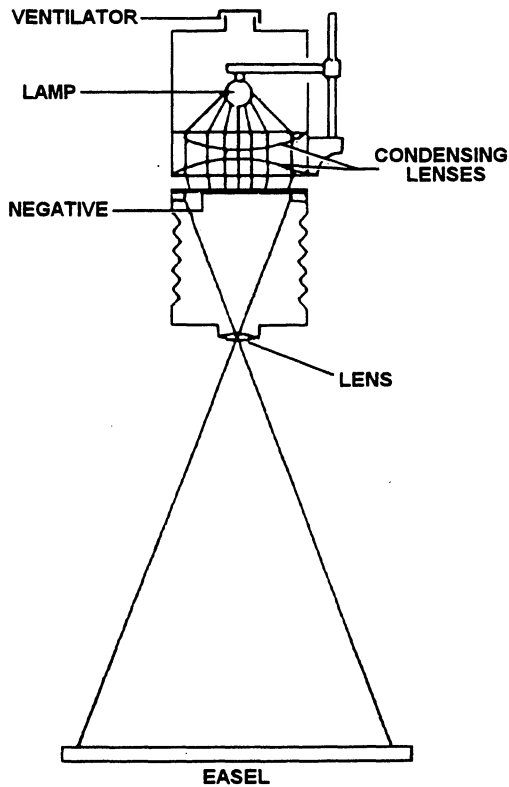

Figure 11-32.—Condenser enlarger.

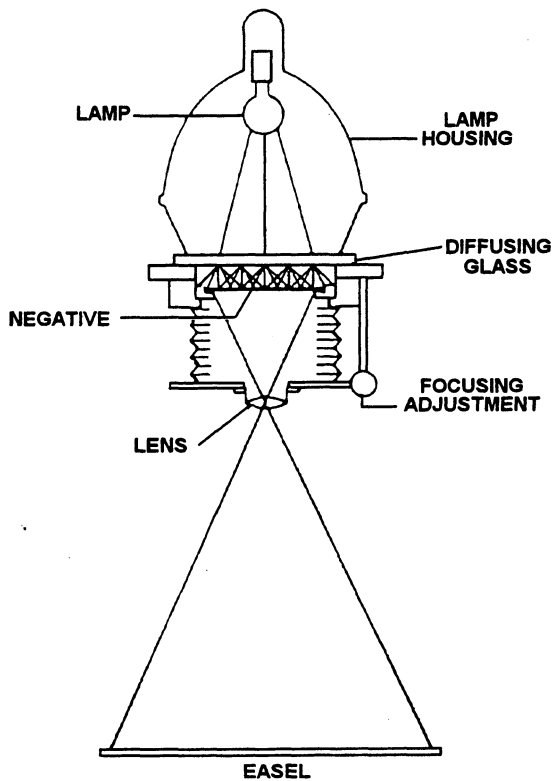

Figure 11-33.—Diffusion enlarger.

is ventilated to prevent excessive lamp heat from damaging the negative. Some enlargers have blowers to circulate air and cool the inside of the lamp housing.

The negative carrier used in an enlarger may be either a dustless type or a glass sandwich type. The dustless type of carrier is made of two metal plates with an opening in the center large enough to hold the negative. The negative is placed between these plates and held in position by its edges. This type of carrier is good for negatives 4 x 5 inches or smaller since these negatives are stiff enough to remain flat. The glass sandwich type of carrier is a holder where the negative is placed between two sheets of glass. This type of holder is used for larger negatives since they have a tendency to sag in the center if they are not supported by glass.

The lens used in an enlarger should have an angle of field large enough to cover the negative being printed. A lens with a focal length approximately equal to the diagonal of the largest negative to be printed will provide sufficient angle of field.

The bellows of an enlarger should be capable of extending at least twice the lens focal length. This amount of bellows extension is necessary for making 1:1 reproductions. Although it is possible to make reductions to any desired size, the bellows on most enlargers cannot be extended far enough to make reductions smaller than 1:1. Smaller reductions can be made by using a longer focal-length lens, but a better method is to use a reducing attachment. A reducing attachment consists of a section of supplementary bellows fitted with a longer focal-length lens.

## MAKING ENLARGEMENT PRINTS

The darkroom arrangement for enlarging is essentially the same as for contact printing. The safelights should be appropriate for the type of paper being printed. The size of the prints may require larger trays and greater amounts of solution, but they should be setup in the sink the same as for contact printing.

For good enlargements, good negatives, a clean enlarger, clean printing filters, correct exposure and development, and careful processing and finishing are necessary. Although most any negative can be printed by projection, there are a few characteristics that are desirable. A good negative has normal density and contrast. It must be sharp and free from such defects as scratches, abrasions, dust, lint and fingerprints.

## Enlarger and Easel Adjustments

Insert the negative in the negative carrier so the emulsion side will be down when placed in the enlarger. In other words, the base of the negative (the shiny side) should be up or facing the lamp when inserted into the enlarger. Clean the negative and be sure there is no dust on it. You can use the light from the enlarger to check for dust. Blow off any dust with a bulb syringe or low-pressure air. Then use a camel-hairbrush to remove any dust that was not removed by the air. Replace the negative carrier with the negative into the enlarger and make sure it is properly seated.

Set the paper guide or masking device on the easel to form the border width needed or use a preset easel. As an aid for composing and accurately focusing the image, place a sheet of white paper in the easel — the base side of the paper is used normally for a focusing sheet — then turn out all white lights.

Turn the enlarger lamp on, open the lens to its maximum aperture, and move the easel around until the desired portion of the image is in the picture area. Raise or lower the enlarger head on the upright standard or column and focus the image. Shift the easel as needed, and continue these adjustments until the image is enlarged (or reduced) to the desired size, focused sharply, and composed correctly on the easel.

The size of projection prints is limited by the optical system used and the working space available. A scene may be printed in sections on several sheets of paper and spliced together.

The picture is easier to compose with the scene right side up. If it is upside down from your point of view, either rotate the negative carrier or remove the carrier and reposition the negative. The image will appear right side up on the easel when it is positioned upside down in the negative carrier.

## Composing the Image

Adjust the picture until the best composition is obtained. When composing the image, try to connect any errors of image composition in the negative. The way the scene is composed on the negative may be a controlling factor in the final composition. You can change the composition of the picture through cropping. This is done by increasing or decreasing the magnification of the image and readjusting the easel.

After the image is correctly composed and focused, the lens aperture should be stopped down so your basic exposure time is about 10 seconds. An exposure time of

10 seconds allows you to accomplish a normal amount of dodging and is fast enough to be practical for quantity production. The exact amount the lens should be stopped down depends on the density of the negative and the magnification of the image. This can be difficult to determine without experience. If you are new to printing, we suggest you start by stopping down the lens to about  $f/5.6$  or  $f/8$  for a normal negative.

## Making a Test Print

There are many factors that effect exposure times in enlarging. Some of these factors include the following:

- The light source and illumination system of the enlarger
- The  $f$ /stop of the lens
- The density of the negative
- The degree of enlargement
- The speed of the paper
- The density and color of the contrast printing filter

The best way to determine the correct enlarging exposure is by making a test strip. Although the test strip is the most reliable way to determine exposure, it is not necessary to make a test strip for every enlargement. It is, however, a wise practice whenever you have any doubt as to the exact exposure required.

You can make a test print using the same procedure in contact printing.

## STILL DIGITAL PHOTOGRAPHY

*LEARNING OBJECTIVE: Recognize the basic process of still digital photography.*

Photographic technology is constantly evolving. A fact that underscores this premise is a relatively new procedure that will eventually change the way all photographers take and process pictures. It is called **still digital photography**.

Still digital photography, as the name implies, allows you to take photographs and store them electronically (digitally) in a specially manufactured camera. You can then process the photographs using digital photographic software installed on the hard disk drive of your computer. This software will allow you to view, crop and color correct your photographs. When you are finished, you may “output” the photographs to

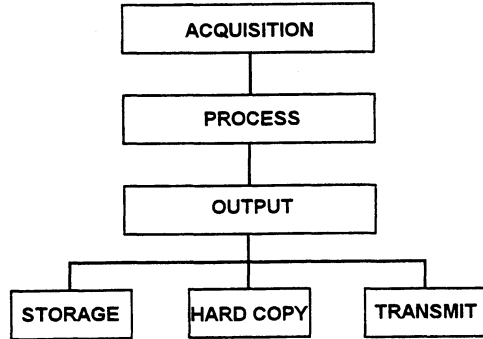

Figure 11-34.—The still digital photography process.

the hard disk drive (for long-term storage), a modem (for transmitting to another computer) or a printer to produce color prints, transparencies or negatives. The still digital photography process is shown in figure 11-34.

## DIGITAL CAMERA

As of this writing, the digital camera used by the Navy is the Kodak Professional Digital Camera System (DCS) 200. This system is shown in figure 11-35 and contains the following components:

- Nikon N8008s camera body
- DCS 200 camera back with hard disk drive (multiple capacities available)
- Small Computer System Interface (SCSI) (pronounced “scuzzy”)
- 28mm Nikon lens and cover
- Aldus PhotoStyler software plug-in for IBM PC and compatible computers
- Adobe Photoshop software plug-in for Apple Macintosh computer
- AC adapter/charger
- SCSI cables

Do not let the name “still digital photography” intimidate you. Because the DCS 200 uses an unaltered Nikon N8008s camera body, you will work with virtually the same components found on a regular 35mm SLR camera. An LCD (liquid crystal display) indicator on the camera gives you important information, such as the battery charge level, frame count and storage capacity (up to 50 images in the camera body). Handy features include auto-exposure, autofocus and auto-wind. You may even change lenses as you would with the Canon F-1.

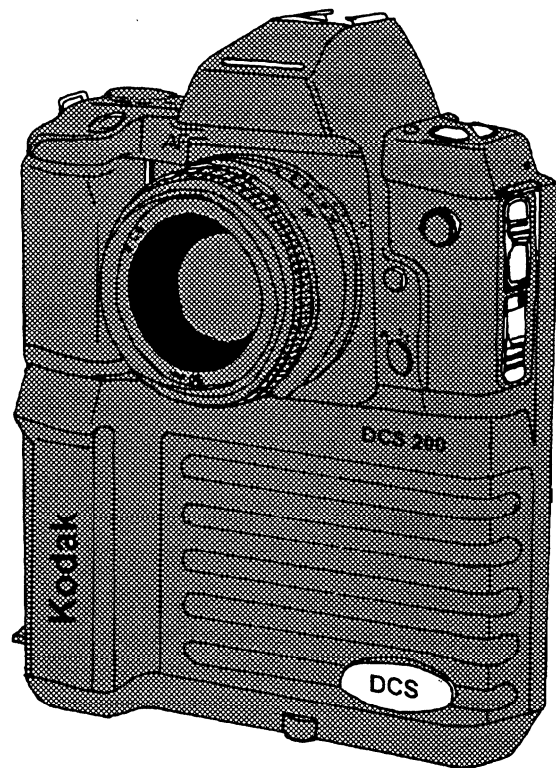

Figure 11-35.—The Kodak Professional Digital Camera System (DCS) 200.

### Batteries

The DCS 200 uses six AA batteries. For maximum performance and to prevent damage to the camera from battery leakage, use alkaline batteries. You may also use rechargeable nickel cadmium (NiCad) batteries.

Do not mix NiCad and alkaline batteries in the DCS 200. NiCad batteries have a different output voltage and battery performance will be degraded significantly.

If the camera is left on when not in use (more than 10 minutes), battery life will drop rapidly. Generally, one set of batteries will provide enough power to take and retrieve 50 images.

### Initial Settings

We cannot adequately cover the entire operation of the DCS 200 in a TRAMAN of this scope. Therefore, you are encouraged to read the instruction manual that accompanies the system.

The following DCS 200 settings have proven successful for most applications and are provided in this section to help you get started:

- Set the focus mode to “S.”

- Set the aperture to f/22 and lock it in position (switch to the right of the distance window on the lens); slide it toward the body of the camera.
- Set the exposure mode to “program” (“P” with no “D” or “H” displayed).
- Set the ISO to 100.
- Set metering to “matrix” (square with larger round dot in center).
- Set the shutter release to “single frame shooting” (S).

## Unique Characteristics

You should be aware of two important characteristics of the DCS 200 camera system. One is that it takes four to six seconds after shooting a picture for the camera to save the image and reset itself. The shutter release must be depressed halfway to “wake up” the DCS 200. It takes two seconds for the hard drive to spin up to speed in preparation, for the shot. Once the DCS 200 is “awake,” the battery status and number of images taken is displayed through the window on the back of the camera. At this point, simply point the camera and depress the shutter release. After you shoot the picture, it takes the camera about six seconds to save the image. Expect to wait about eight seconds before taking the next picture.

## RETRIEVING YOUR IMAGES

The DCS 200 works with either the Aldus PhotoStyler (IBM PC and compatibles) or Adobe Photoshop (Apple Macintosh) software programs. In this section we will show you how to access and compress your images using the Adobe Photoshop software. Compression of the image is necessary for modem transmission

**NOTE:** Consult the Apple Macintosh and Adobe Photoshop instruction manuals before attempting this procedure.

Use the following steps to access and compress your images:

1. Place the camera next to the computer before starting. Connect the DCS 200 to the computer using the appropriate connectors/cables.
2. Turn the camera on. Make sure the batteries are providing adequate power.

3. Turn the computer on. Create a folder to store your image files in for transmission.
4. Launch the Adobe Photoshop application.
5. Click on the “File” menu. Holding the mouse/trackball button down, drag down to “Acquire.” Still holding down the mouse/trackball button, drag over to the right and select “Kodak DCS 200.”
6. After a few seconds, the Kodak Professional DCS 200 Camera window will appear (fig. 11-36).

**NOTE:** You may also get an error window indicating that the camera was not found. If this happens, make sure the camera is on. Then depress the shutter release halfway to “wake up” the DCS 200. Immediately click on the “try again” button in the lower right corner of the error window. If this fails, you may need to check the configuration of the software and connections.

7. The first images you shot should now appear as small black-and-white “thumbnails.” Select an image by clicking on it once. You will see a striped selection ring form around the image.
8. Click on “Acquire” to the right of the images. The camera will begin downloading the image into the Adobe Photoshop application. This takes about one minute.
9. The image will appear on the screen at one-third its actual size (as indicated by the 1:3 at the top of the image window).

**NOTE:** Consult the Adobe Photoshop instruction manual before making any alterations to the image!

10. Click on the “Image” menu. Holding down the mouse/trackball button, drag down and select “Image Size.”
11. Turn off the “File Size” option by clicking in the marked box.
12. Using the tab key, select the smaller of the height and width dimensions listed (14.056). When this box is highlighted, type in this new size: 7.028. If you have done this correctly, the three sizes listed in the window should read as follows:
  - New size: 1.10M
  - Width: 10.584
  - Height: 7.028

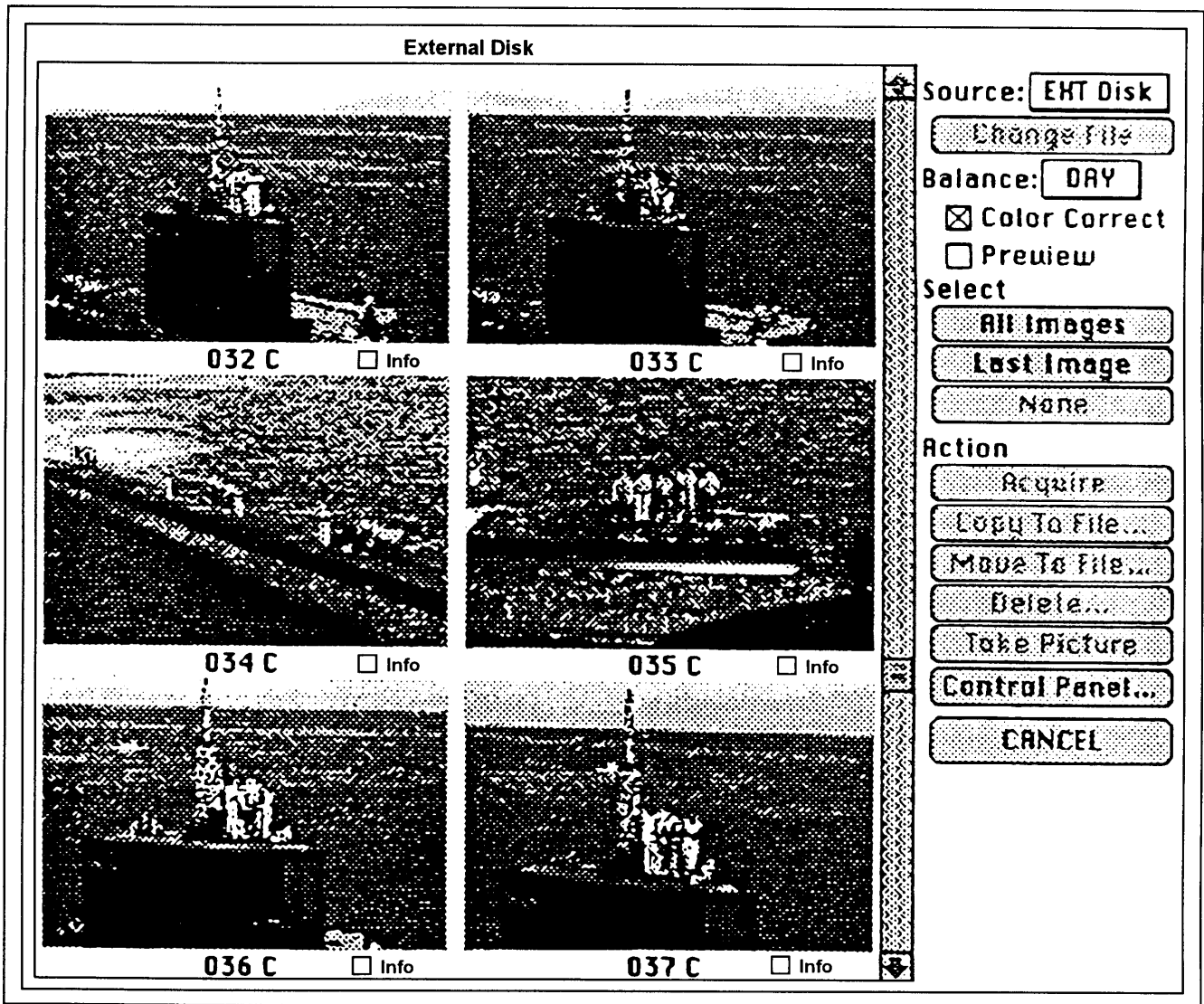

Figure 11-36.—The Kodak Professional DCS 200 Camera window in Adobe Photoshop software.

Click on “OK” and the computer will return to the image. If these values are not reflected, click “Cancel” and begin again at Step 10.

**NOTE:** If the image was shot vertically instead of horizontally, the height and width measurements will be reversed.

13. Click on the “File” menu. Holding the mouse/trackball button down, drag down to “Export.” Still holding down the mouse/trackball button, drag over to the right and select “Adobe JPEG Compress.”

14. In the “Adobe JPEG Compress” window (fig. 11-37), move the sliding image quality control bar to the center of the scale directly below “Good.” Make sure “File Type” is “JPEG.” Select the folder you created earlier to save your files; then enter a name for your file. The file name must end in “.JPEG.” Press “Save.”

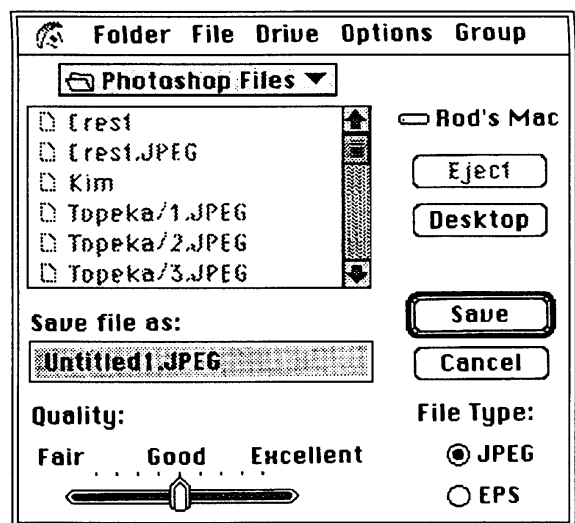

Figure 11-37.—Adobe Photoshop JPEG compress window.

15. Click on the “File” menu. Holding the mouse/trackball button down, drag down to “Close.”

You have just successfully retrieved and compressed a digital image. The image is now ready to be transmitted by modem using the telecommunications software of your choice. Repeat Steps 5 through 14 for each image you desire to transmit. When you are finished, quit the Adobe Photoshop application.

In this section we attempted to give you the basics of still digital photography. Further information may be obtained from the *Photography (Advanced) TRAMAN* or by contacting the CHINFO News Photo Division.

## PHOTO JOB ORDERS

*LEARNING OBJECTIVE: Identify the purpose of the photo job order and list the required photo job order information.*

In areas where Navy imaging facilities are located, one of the easiest means of getting photographic coverage is by properly filling out a job order form. The title of the form may change to include other services, but you should have an understanding of the purpose and basic information needed to fill out the request for services properly.

A job order serves as the authority for requested work the record of the imaging facility and its receipt. It accompanies the work being performed through every phase of the photographic process.

To use the job order successfully, you should develop a good understanding and relationship between your unit and the imaging facility.

In submitting a job order, all information pertaining to the job should be recorded to avoid confusing the photographer performing the actual work. The job order information you must provide includes the following:

- Name of your activity
- Your activity job number
- Job security classification
- Number of views needed
- Size and finish of prints
- Priority and date required
- Location of work
- Name and telephone number of person requesting job
- Person to whom the photographer should report; also the date and time the services are required
- Description of the job to be photographed
- Uniform the photographer should be wearing

The most important information of the job order is the concise description of the job to be photographed. All information pertaining to the job should be described as clearly and complete] y as possible to avoid any confusion for the photographer.

Your relationship with the imaging facility personnel should include an understanding that your job orders always allow for a creative or imaginative shot along with the requested standard or sure-shot. In cases where the photographer’s shot is better than the shot requested, use the better shot. **Never** request “one to 10 of every shot.” Should you be allowed to select your prints by screening proof sheets or negatives, select only the best shots to satisfy your requirements.

Another method you should use to foster good relations with the imaging facility is to rely on the judgment of an experienced photographer and request the “best view of ...” when ordering prints.

## CHAPTER 12

# BASIC PHOTOJOURNALISM

Photojournalism is a form of communication that plays a vital part in modern news reporting. To convey their message, photojournalists use a harmonious combination of photographs and words. Many of the leading magazines and newspapers attribute success to photojournalism. The reason for this is simple — a good photograph can, at a glance, portray the essence of a news or feature story.

Well-composed, action-packed photographs with carefully worded photo captions have reader appeal, realism and permanence. Do you remember the photographs of the raising of the American flag over Mount Suribachi, the signing of Japan's surrender aboard the battleship USS *Missouri* (BB 63) (fig. 12-1), the swearing-in of Lyndon B. Johnson aboard Air Force One or Neil Armstrong and Edwin "Buzz" Aldrin

planting Old Glory on the moon? How many of the words written about these events do you remember?

The photojournalist's objective is to communicate primarily through photographs. To be an effective their photojournalist, you must understand the following fundamentals:

- **Know your subject.** You cannot communicate information about a subject of which you have no knowledge.
- **Know why you are communicating.** You should always have a purpose for your message. The purpose might be as simple as sharing an emotion or experience.
- **Know to whom you are communicating.** Is it a specific audience that has some knowledge of your subject, or is it a "mixed bag"?



U.S. Navy photo

**Figure 12-1.—Fleet Adm. Chester W. Nimitz signs the Japanese surrender document aboard the battleship USS *Missouri* (BB 63). Looking on, from left, are Gen. Douglas MacArthur, Adm. William F. Halsey and Rear Adm. Forrest P. Sherman, of Staff for Fleet Adm. Nimitz.**

- **Know how to use the camera.** Your camera is a mechanical device that only sees a limited area and exercises no selection over the action that takes place in front of it. As a photojournalist, you can use this limited view to exclude extraneous subject matter and to focus on your message. You do this by determining which lens, camera angle, lighting method and timing will capture the photograph that will best communicate your story.

This chapter introduces you to photojournalism and covers some of the techniques by which it is applied. Maximum emphasis is placed on achieving good photographic composition, interest, impact and technical quality. Granted, the basic information contained here is not sufficient to qualify you as a Navy photojournalist in the strictest sense. However, if you learn and use this material, you can become a proficient news photographer and an asset to the public information efforts of your command.

## **HISTORY OF MILITARY PHOTOJOURNALISM**

*LEARNING OBJECTIVE: Describe the history of military photojournalism.*

The history and growth of military photojournalism has been brief, but significant. It started when Matthew Brady and his assistants were commissioned to document the Civil War pictorially. Their photographs were made on wet plates that had to be processed immediately, thus limiting mobility. The film they used was of low sensitivity; therefore, action photography was out of the question. Further, there was no means to get the photographs to the publisher quickly, so interest was limited. No processes for reproducing a photograph in a newspaper were known at that time, except by having an artist copy them into line drawings. These problems did not destroy the desire for photographs or the value of photojournalism as it existed then, but rather posed challenges to cause people to search for a better way to use the photographs taken.

By the time of the Spanish-American War (and the equally important Hearst-Pulitzer circulation war), camera equipment had evolved into a smaller, portable form. Film on an unbreakable cellulose base had been invented that could be exposed in one place and processed many miles away and many hours later. Film sensitivity had improved so that action could be photographed. Quicker transportation meant more timely delivery of news photographs to the publisher, while their news value was still high. Methods of photo-

engraving, though still crude, allowed newspapers to print several halftones along with etchings and linecuts.

Military photographers took many photographs during World War I, but the importance of these photographs as an adjunct to the written history of the war was not realized for many years.

The period between the World Wars was very important to photojournalism. "Plaything" photography yielded to more exacting photography as a science. Cameras designed for presswork became available in a price range within the budget of the average newspaper. The sound motion picture, the miniature camera, the fast lens, the flash lamp, flash synchronization, and hundreds of film, emulsion and laboratory innovations were put to use. Most important, the public desired news photographs and editors accepted photography as a tool of journalism.

World War II saw news photography in the military services rise considerably. Early in the war, the services drafted professional photographers and formed teams to document the history of United States international involvement. They went one step further by using their talents to show the horrors of war. They took photographs with stopping power, photographs that had impact and photographs that forced the viewer to look and read the copy.

By the time of the Korean War, photography rose above an improved and exacting science and became a finer skill. Photographers began to document moods and feelings, to look for photographs that expressed what was not readily apparent on the surface and to concentrate on photographs for news releases. It was during this period that the military photojournalist became a professional.

During the Vietnam War years, photography continued its advances in equipment and processes. Along with these advances, photojournalism reached new heights, providing just short of a "you were there" atmosphere of the war. Today, the military photojournalist is a mainstay of the military establishment — a vital contributor to the internal and external public affairs efforts of a command.

## **PHOTOGRAPHIC COVERAGE ELEMENTS**

*LEARNING OBJECTIVE: Identify the elements of photographic coverage.*

Photographic coverage is invaluable in most publications. Through effective layout, photographs can be used independently as lead stories with merely a cutline accompanying them. In other uses, photographs





PH2 Lawrence T. Henderson

**Figure 12-2.—News photograph with action and impact.**

can support headlines and written spot news accounts as well as feature stories.

The photograph serves as a definition for words. No two people imagine identical photographs through words alone. Groups of words rarely cause similar mental images in everyone. Different people see different photographs in their mental interpretations of verbal descriptions of a given scene. From a photograph, everyone gets the same mental picture.

## **TYPES OF NEWS PHOTOGRAPHS**

What is a news photograph? Just about everything said about recognizing and gathering news also can be applied to the news photograph. News photographs also have common news elements. These same 10 elements — immediacy, proximity, consequence, prominence, suspense, oddity, conflict, sex, emotion and progress — are essential to successful photojournalism. You can judge the newsworthiness of a photograph by the degree to which these elements are present. The newsworthiness of a photograph, like that of an event, depends on the strength of intensity of the news element it contains.

Nearly all news photography is classified into two categories: **spot** and **feature news**. This applies to sports as well as any other type of newsworthy activity. Since the spot news photograph achieves a dramatic quality, the unrehearsed action is obvious to the reader. The feature photograph, on the other hand, consists of elements that allow it to tell its story with a brief cutline, or on many occasions, without a cutline.

### **Spot News**

In covering unrehearsed action, control over the kind of photograph you will get is somewhat limited by the situation. For example, in shooting a boxing match, you work at top speed and usually under great pressure. You record developments as they occur with little regard for the control of the men in the ring. Your ingenuity and alert observations will have to be called upon to ensure any technical quality at all. In shooting well-known personalities, you should photograph them doing something. A photograph without action, regardless of the prominence of the personality, is not in itself a storytelling photograph. The successful and usable news photograph has action and impact (fig. 12-2) and



Master Sgt. Don Southerland, USAF

**Figure 12-3.—Award-winning feature photograph.**

immediately draws the reader's attention either to the outline or to the accompanying story.

### **Feature News**

The purpose of the photo feature is to tell a story about a given subject, selected and planned by the photojournalist, using real people or real things, in real or believable settings. As the photojournalist, you arrange everything to appear as if the story were actually happening; you will have full control over composition, posing, arrangement and expressions of the subject. An example of an award-winning feature photograph is shown in figure 12-3. You should create a lighting effect that establishes mood or realism in your photograph, and select the precise camera angle needed to give emphasis to your photographs.

In shooting the feature story, you are rarely hurried and there are opportunities to change your setups if you are not entirely satisfied. You also may take time to exercise your technical know-how (in processing

control) to produce a photograph of the highest quality. An additional advantage of feature photography is that you may “cover” yourself by taking additional photographs; the straight news photographers afforded little more than a split second for the quick “grab” shot.

### **COVERAGE PLANNING**

Planning is essential to good news photography. When you are aware of the subject or event you want to portray, plan the photographic coverage so the story may be told through photographs alone, if necessary. The photographs must have imagination and a professional news touch if the results are to be acceptable to the news media.

Strive for simplicity, interjecting the human element into your photographs. Create impressions, use people and always remember that it is people and what they do in everyday life that make news.

Keep the following tips in mind when you plan coverage of news events:



Tony Giberson  
165.3

Figure 12-4.—“Posed” photographs should appear as if the action were spontaneous.

- Shoot only when you have in mind the type of photograph you intend to take.
- Keep the photographs from looking posed. Posed photographs are permissible and for best results, it is often necessary for subjects to pose, but this fact should not be discernible in the finished photograph (fig. 12-4).
- Set the stage, place the props for dramatic effect and tell the people what to do and how to look. As we emphasized in Chapter 11, you must be in charge when directing photographic subjects.
- Resist the temptation to ask the photographic subject(s) to “hold for one more.” Most people will do almost anything required for the first take; thereafter, they lose interest quickly in cooperating with the project, and the photograph ultimately suffers. However, if you

feel that for some technical reason you did not get the photograph the first time, do not hesitate to speak up and ask for another shot. Remember, you were sent on the assignment to get pictures, and this is what you are expected to deliver.

- Photograph the faces that fit the emotion. A smile or pleasant expression does not show a lack of dignity; it shows that Navy men and women also have fun.
- Move in on your subject and make your photographs show the desired action. Seldom, if ever, will you be concerned with sweeping panoramas, unless they tell the story you want told.
- Learn as much as you can of the event, the shooting locale and the principles involved before you leave the public affairs office.

### Identification

Always record sufficient information so you may properly identify and prepare cutlines for your photograph upon returning to your office. Using a notebook or caption log to record cutline information was covered in Chapter 9. Additionally, you may have an assistant jot down the information or tape record it as you go along.

### Shooting Script

Some professional photojournalists plan their shooting with great care, including a complete shooting schedule or script. You should study the script before the assignment and commit it to memory, rather than checking it shot by shot at the scene. Often, you may have to depart from your script when shooting at the scene. You must stay one jump ahead of the action, and when the unexpected occurs, be prepared to make a change — remembering your story angle and objectives.

A good script is usually divided into two parts. The first part is concerned with the general idea of the picture story. All pertinent information, such as names, places, times and contacts are listed in this part. The second part lists the picture ideas and the information pertinent to each shot.

**PART ONE.**— The research of a photo feature theme is of the utmost importance to the success of any picture story. A firm idea of what is going to be shot and the approach that will be taken is needed before shooting

can begin. Therefore, in part one of the shooting script, you should complete the following sections:

- **Who**— The name of the individual or subject that will be photographed. The job, title and duty responsibilities of the subject should be included, if applicable.
- **What**— The exact nature of what the subject will be doing in support of the overall theme of the photo feature.
- **When**— The time and date the subject will be photographed. Make sure the subject will be available at the time specified
- **Where**— The exact location or locations where the photography will take place. Make sure the specific area will be available at the time indicated.
- **Why**— Why will this photo feature visually interest your audience? State the reason(s) why the subject will appeal to a given audience. (**Planning**— List three to seven picture ideas in order of their visual flow.)
- **How**— List all arrangements that must be made to enable you to carry out the assignment. Include name(s) and telephone number(s) of contact(s) assisting with the event. Also list the photographic equipment (type of camera, lenses and specific lighting accessories) and props you will need.

**PART TWO.**— Part two of the shooting script should contain a well-planned list and description of, and reasons for, the photographs you determined will best represent the story. For example, if you were doing a picture story on the Navy's flight demonstration team, the Blue Angels, one desired photograph might be identified as follows:

SHOT 1: LONG SHOT

**INSTRUCTIONS:** Aircraft flying in close formation. Shoot with the operations tower in the foreground, from low angle, for perspective.

**REASON:** To show the reader the precision flying ability of the "Blues" and to identify the location of their performance.

Other planned photographs in the photo feature should be addressed similarly. The following information should be listed for each proposed shot:

- The angle of view (high, low, front, side, back, and etc.)
- The action (implied or actual) expected to take place
- The type of shot (long, medium, close-up or extreme close-up)
- The desired depth of field or point of focus
- Any unusual lighting conditions

Finally, you should storyboard each picture idea to assure a unified picture page with emphasis placed on leading lines, lines of force, framing or rule of thirds. Storyboarding (fig. 12-5) entails sketching out each planned photograph beforehand, giving visual direction to your list of desired shots and numbering the sketches accordingly.

The sketches do not have to be works of art (stick men representing your subjects will suffice), but they should be recognizable as visual descriptions of the planned photographs on your list.

Remember, the shooting script is only a guide for shooting a picture story. With a basic idea of the subject and its importance (accomplished through research), you can better understand the subject and obtain superior results.

### Shooting Script Techniques

A good shooting script should include the following techniques:

- **Change of pace.** During the actual shooting session in covering a particular subject, interest must somehow be maintained in the story. Interest can be retained by having a change of pace or variety in the coverage technique used by the photographer. Static coverage of a subject can be eliminated by first understanding the reason for certain types of pictures to be taken, and second, by keeping these points in mind during the script writing and the actual shooting.
- **Long (perspective) shots.** Taken from a distance or with the aid of a wide-angle lens, long shots show the subject in its entirety, relate it to its surroundings and clarify the relationship of its different components to one another. They are photographs that, at one glance, present many different aspects of a subject that subsequently is further explained in some of the other photographs in the story. This type of photograph

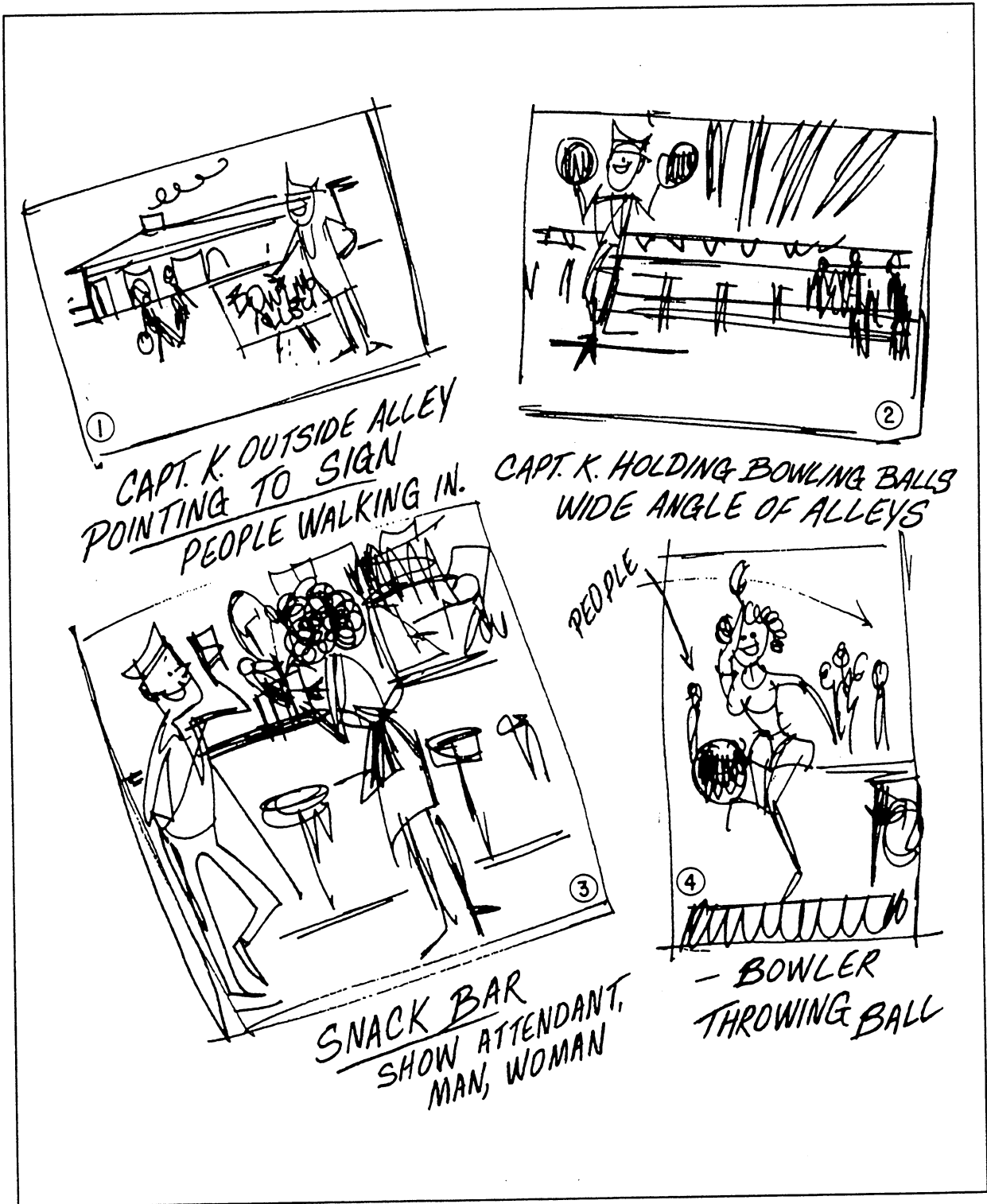

Figure 12-5.—Storyboard.

is best taken from a high vantage point, such as a roof, scaffold or ladder.

**Medium shots.** Medium shots normally comprise the bulk of the photographs that make up the picture story. They correspond to the

impression the eye receives in reality. They are used to show people, objects, things, interiors and action.

- **Close-ups.** Close-ups are explanatory photographs that permit the photographer to show



Staff Sgt. Bill Thompson, USAF

Figure 12-6.—Picture sequence in a picture page layout.

important aspects of the subject in greater clarity and detail than would have appeared in reality to an observer. Only in the form of a close-up can a face, pair of hands performing a certain function or small but important object appear monumental, interesting and in proper proportion to its significance to the story.

- **Horizontal and vertical views.** Shoot both horizontal and vertical views of your subject — with the same action portrayed when possible. This provides more latitude when you construct a picture story layout. You can usually crop long shots during the layout process to meet design requirements, but not medium and closeup shots.

### Tentative and Final Layout

Picture stories are not just a haphazard gathering of photographs. The photographs used must have specific functions. The use of one photograph, as opposed to another, is closely aligned with the layout design. Even as you take photographs, you should consider the picture story layout.

The lead photograph is not necessarily the first picture in chronological sequence, but the picture that contains the essence of the story. Within the layout, the lead photograph is usually the largest and placed to attract the reader's attention.

Body photographs are those that actually communicate the story. They must use compositional techniques to present interesting and stimulating photographs. The editors should strive to present the photographs in different sizes and formats as well as presenting rights and lefts, highs and lows, longs and close-ups, and at the same time, using the minimum number of display elements. Allow for maximum latitude when selecting your visuals.

You also should consider end photographs during the planning phase of the picture story. Not all picture stories have definite endings, but all should bring the reader to the significance of the story.

After accomplishing the preceding tasks, you are ready to take photographs. The law of averages indicates that the more you take, the better your chances are of getting exactly what you want. However, if you are properly prepared, your photographs will not be a number of unrelated shots, but will be several sequences that cover the specific picture ideas listed on the script. This method was used during the first landing of the space shuttle (fig. 12-6). By covering your assignment in this manner, you will have a variety of visuals that can be used in a picture page layout.

### Equipment Readiness

Speed is the essence of news photography, especially spot news that just happens. Therefore, it is crucial that you always have a ready camera on hand

with an adequate supply of film, flash and associated equipment. When a spot news event occurs, you will not have much time to get your gear together and check it out. This means you must start your day off with a complete check of the equipment available to you.

When possible, keep two cameras ready — one loaded with black-and-white film and the other with color slide film (for release to electronic media).

As you read in Chapter 11, you should keep your camera free from dirt, dust and moisture and also handle it with care. Store it in a readily accessible place in its carrying case when not in use.

## **Self-Confidence**

Gaining an attitude of self-confidence is one of the most difficult and important aspects of becoming a good news photographer. A “personality for the profession” is a prerequisite for anyone who wants to become proficient in the field of photojournalism.

To succeed, you must look upon occurrences with an objective view. The knowledge of the mechanics of photography is not enough. You must have an inquisitive nature that inherently causes you to want to know more about what is going on around you. Diligence, study and practice are necessary to use the tools of the trade proficiently; aggressiveness and the will to understand the motivations of others will aid you in your quest for competence.

Those who have a thorough knowledge of their field and consistently display such attributes as honor, finesse, diplomacy, courtesy and honesty, as well as straightforwardness, automatically develop self-confidence.

All too often a photographer misses pictures of great pictorial value because of the lack of aggressiveness. Upon receipt of an assignment, your whole attitude must be that of determination. Come what may, you must get photographs. Navy photographers and journalists are frequently in contact with notable personalities from military organizations, local and federal governments, foreign countries, private industry, and hundreds of people from all walks of life who at some time or another have had an association with the Navy or other armed forces.

Almost without exception, all of these people may be photographed without incident under nearly any circumstance. Fear of what is ahead and fear of standing in the shadow of great people cannot be a part of the personality of the news photographer. You should be

respectful, as appropriate, but you should never feel subservient or inferior. Finesse, courtesy and straightforwardness in pursuing the job at hand immediately result in cooperation as well as quick action in seeing that the mission is accomplished.

People being photographed rely on the photographer’s ability to get the coverage desired and usually await the photographer’s instructions. Photographers and reporters are not unfamiliar sights on the horizon to the VIP. When people have reached a point in life when they have become public figures, they are conscious that they no longer enjoy the privacy of the average citizen. Therefore, knowing they are news, they are ready and willing to assist members of the working media. However, they cannot do this until you have presented yourself. When your presence is noted, your VIP subject knows, through many years of experience, that your job must be done with speed in order to meet deadlines.

In presenting yourself to a subject, the initial introduction normally is made by an aide or assistant; however, there are times when you must do this yourself. An honest and courteous approach at a diplomatic moment can be done easily. Simply remain in close proximity to your subject and await the earliest break in conversation; then step forward and state your name, rate, place of duty and your reason for being there. When you are acknowledged, take the minimum time necessary to get your photographs. Work with sureness, deftness and thoroughness. If you feel you did not get a photograph, bring this to the attention of your subject immediately. Often you will find that straightforwardness gets you a second chance that so seldom comes to the news photographer. If it is impossible to shoot another photograph at that particular moment, keep your eyes open and remain on the alert. Another opportunity may present itself, so be ready for it.

## **CREATING GOOD PHOTOGRAPHS**

*LEARNING OBJECTIVE: Describe the basic elements of creating good photographs and the inherent security and safety considerations.*

Creating good photographs (news, feature or otherwise) depends heavily on the imagination and know-how of the person behind the camera. You must have a storehouse of imaginative ideas for presenting simple, yet interesting photographs that emphasize a definite point of view. The shot must have both visual and emotional impact and offer the viewers a



Tony Giberson  
165.4

Figure 12-7.—Feature photograph offering a unique view.



perspective they do not always see (fig. 12-7). All of the qualities mentioned are a must for a news photographer striving for good photographic composition.

Essentially, photographic composition is a harmonious combination of a main subject and its supporting elements. This means you must be able to recognize these elements and then arrange them into the photograph that will tell your story.

Learning the art of good composition is similar to mastering any other skill. First you must understand the rudiments. Then, through much practice and attention, you develop your talent to the highest degree of perfection possible.

In the early stages of learning, we depend almost exclusively on what we can see and hear, imitating what has been done before. Much can be learned about composition by studying various works of art and collections of good photographs. Each one offers an example of how to present a subject in an effective and interesting manner. By attempting to duplicate some of these photographs, you can acquire an understanding of the basic elements of composition.

The proper placement of the subject within the space of the photograph is one of the most important elements of good composition. Whenever possible, you should select and arrange the subject elements, choosing the viewpoint and lighting conditions that present the subject best. You also should arrange the subject in the photograph in such a way as to clearly and predominantly be the main point of interest. The main idea of the photograph should be recognizable immediately to anyone viewing your photograph.

In aiming for good composition, you should learn and use the following principles as guides: 1 Simplicity

- Point of interest
- Compositional lines
- Balance
- Forms
- Rhythm or pattern
- Tone
- Depth perception
- Action
- Security and safety considerations

Your awareness, application and practice of these principles when composing a scene will assist you greatly in making an interesting presentation of your subject.

## SIMPLICITY

Frequently, the simplest arrangement of your subject matter makes the most interesting presentation. Although each photograph consists of numerous small parts and contributing elements, none of these should appear conspicuous or portray more interest than the main object. The main object is the reason for making the photograph in the first place; all other elements should merely support and emphasize it. The scene should not be cluttered with a confusing number of objects and lines that detract from the subject. You should select a viewpoint that eliminates surrounding distractions so the principal subject is readily recognized. If numerous lines or shapes are competing for interest with the subject, it may be difficult to recognize the main object or determine why the photograph was made.

Study the scene from all angles and decide exactly what you want to show; then strive to maintain this single idea as clearly as possible by eliminating unimportant or distracting elements from the photograph. Keeping the arrangement simple makes the job of composition easier and the photograph more interesting.

## POINT OF INTEREST

With few exceptions, most photographs should have a single point of interest that tells the viewer this is the reason for taking the photograph. All other details support the point of interest. The point of interest is the point to which the eyes are drawn (fig. 12-8). If there is

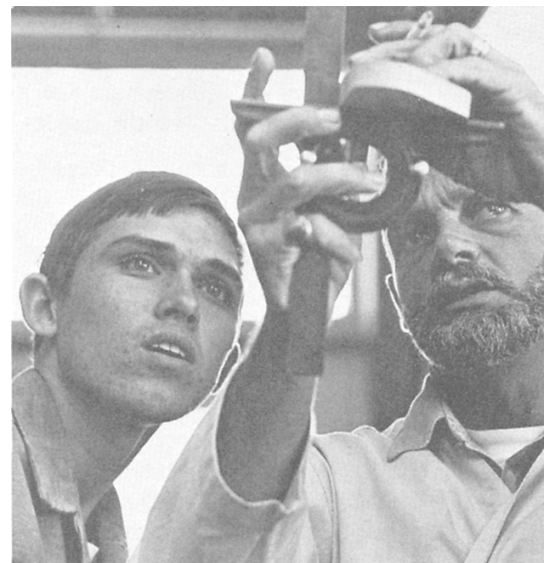

**Figure 12-8.—The eyes of the viewer are drawn to the point of interest.**

nothing in the photograph to attract attention to a particular area, the eyes wander throughout the scene. The point of interest maybe a single object or numerous ones arranged so that attention is directed to one definite point.

Lines, shapes, human figures, and so forth, should be directed so that they look or move toward the point of interest in the picture. If you have a group of people gathered around a table, keep the interest intact and centralized by having them look at each other or at one individual of the group. A perfect example of this is *The Last Supper* by Leonardo da Vinci. This unity of interest causes the observer's eyes to be drawn to the same point. Human figures attract attention more strongly than most other subject matter.

For instance, a photograph showing a person standing at a distance in front of a building may leave the observer wondering whether the person or the building is the main subject. When you include people in a scene, do not photograph them looking directly at the camera. When people look directly at us, we normally return the gaze by looking directly into their eyes. However, when they look in another direction, our attention is drawn from them to the point at which they are looking. Thus if people are grouped around a piece of machinery or an aircraft (the main object of the photograph), have them look at the object, rather than at the camera.

### Rule of Thirds

Point of interest, as used in this section, is frequently called the center of interest. It is called "point" at this time simply to prevent giving the impression that it would be located in the center of the photograph space.

Although good composition can at times be obtained by placing the point of interest in the geometrical center of the photograph area it is a good idea to avoid placing it there. The frequently it divides the photograph into equal halves and makes it difficult to create a feeling of balance. Some photographers draw lines on the ground glass, dividing the photograph into thirds both vertically and horizontally, and thereby locate the point of interest at one of the four intersections of these lines. This division is sometimes referred to as the rule of thirds (fig. 12-9) — a concept briefly covered in Chapter 8. You will find that one of these intersections is the best location for the point of interest and gives the best feeling of balance to the composition of the photograph. Most of the attention should be attracted to and held at this point. An artistic feeling for

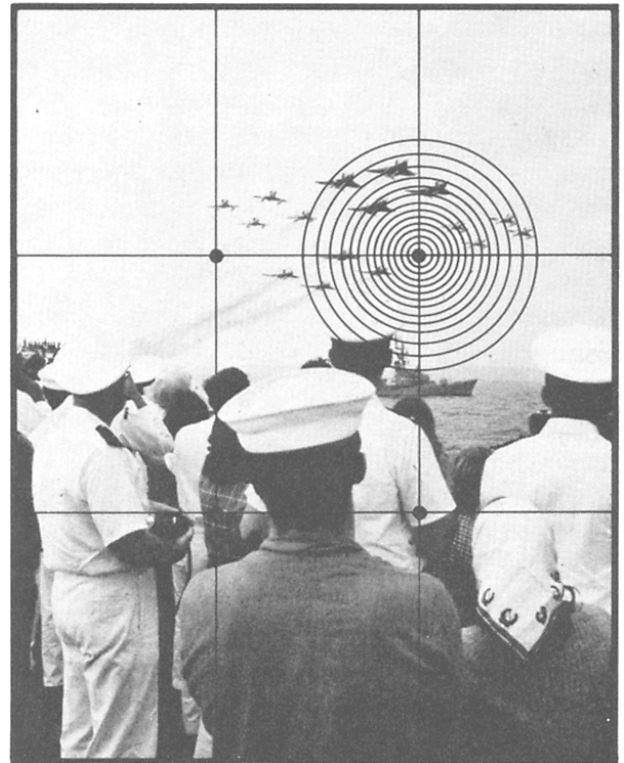

**Figure 12-9.—The rule of thirds**

arrangement is an invaluable aid in composing a scene in order to make a striking photograph.

If the principal object is too close to one edge, appears top-heavy or if it in any way leaves the observer feeling that it is misplaced in the photograph, the point of interest should be moved to another location. You also may change the camera angle to include another object and balance the composition.

### Leading Lines

One of the most common techniques in directing attention toward the point of interest is the use of leading lines, shapes or patterns. You can use leading lines to convey psychological impressions; curved lines lend grace to a photograph and strong horizontal lines combined with vertical lines indicate strength and power. The leading line may be a road, an armor leg, a shoreline, a patch of light or dark tones in the scene, or a line of sight (fig. 12-10). A good leading line is one that starts near a corner of the scene and continues unbroken until it reaches the point of interest. It should end at this point; otherwise, attention is carried beyond the main object in the photograph.



**Tony Giberson  
165.5**

**Figure 12-10.—Leading lines.**



**Figure 12-11.—Framing the point of interest using a cargo net.**

### **Foreground and Background**

The area in front of and behind a subject can be used to develop depth in a photograph. For example, when you place objects relevant to the subject in the foreground, the foreground and the subject (in the middle ground) both become elements of interest in the photograph.

However, you should avoid a busy foreground or background. Too many details or unattractive components will detract from the main subject. For instance, a flagpole or a sword in the command insignia appearing to grow out of someone's head obviously harms the effect of the photograph.

The foreground or background also can be blurred intentionally by camera settings and selective focusing to draw attention to the subject.

### **Framing**

Another method of confining attention to the point of interest is by framing it with foreground objects (fig.

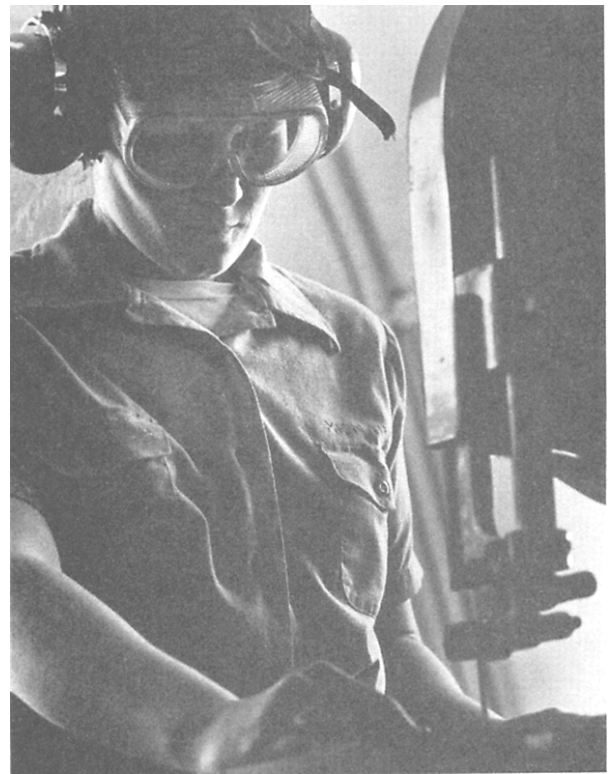

**Figure 12-12.—Informal working portrait shot from a low angle.**

12-11). The object could be an arch, a window, a tree limb or even an arm or leg.

### **Camera Angle**

The camera angle also is very important in good composition. It can help you place emphasis where you want it. Angles can be used to create the unusual when the scene is commonplace. Using a high, low, left or right angle relative to your subject can produce an entirely new effect. Avoid shooting everything from the common eye level. This is the same view seen by your viewer all day long. Walk around the subject and determine which viewpoint will have the most impact or the most pleasing effect.

When the camera is placed above the level of the subject, it creates a distant and detached view. Shooting from a low angle produces a dramatic and a statuesque effect (fig. 12-12). When the camera is aimed at a 45-degree angle toward the subject, it lends depth to the subject and gives the best identification. On the other hand, a frontal view creates a flat appearance and will not last very long in the viewer's mind.

## Lighting

Lighting is one of the important creative elements of composition. When you control the light and direct it where it is wanted, minor objects or distracting elements in the scene can be subdued and thereby give more prominence to the main point of interest. The type of lighting best suited for a subject depends on the type of subject and the purpose of the photograph. If maximum detail is desired in the shadows, the illumination should be soft and diffused. Sidelighting is most effective in showing texture. However, light falling diagonally on the subject from above and to one side of the camera is the most natural form of illumination. We are accustomed to seeing most subjects under this condition in which the shadows are cast off to one side and slanted away from us, creating the greatest apparent depth and roundness in the subject.

Shadows are the key to apparent depth in a photograph. Without shadows the subject is without form, curvature or texture, appearing flat and lifeless. This does not mean that shadows should be harsh and black to achieve these effects. They may be soft, yet of sufficient density to show the most delicate roundness of form. As a general rule, harsh black shadows are undesirable in a photograph due to the complete loss of detail in them. From a compositional standpoint however, black shadows can be very useful in balancing a scene and directing attention to the point of interest. While viewing the scene from various angles to select the best camera position, note the effects of illumination. In all probability, the most complimentary lighting on an outdoor subject occurs only during one short period of the day. For this reason, time your photograph to take advantage of the most suitable available light or plan to create your own illumination with auxiliary lights.

## Silhouetting

Silhouetting is when a subject is backlit and then underexposed. A silhouetted subject gives overall strength to a composition and isolates the subject through contrast of the dark foreground against the lighter background (fig. 12- 13).

## COMPOSITIONAL LINES

The formation of lines in a composition is unavoidable. For example, lines are formed by the



**Figure 12-13.—Silhouetted subject.**

horizon, a person's limbs, the side of a ship, a fence or a winding road. These lines — vertical, horizontal, diagonal or curved — lend their own element of emphasis to a composition.

Vertical lines formed by elements in composition suggest strength and dignity (a sentry at attention), while horizontal lines suggest tranquility and rest (a ship on the horizon at sunset). The diagonal line suggests action (climbing aircraft) and a variety of lines indicates activity. A feeling of grace and beauty is conveyed to the viewer by the use of curvaceous lines, such as those used in glamour and fashion photography.

## BALANCE

A good composition should have balance. In other words, your viewer should not get the uneasy feeling that the elements may come tumbling out of your composition.

A balanced composition gives a feeling of harmony to the whole setting. Elements of balance are placed in opposing sections of a photograph in such a manner that each section appears to have an equal amount of weight



**Figure 12-14.—Compositional balance.**

or value, and the objects all appear to belong in the scene. Balance can best be achieved by offsetting unequal sizes, shapes, tones or objects in a scene.

A good method of balancing objects of unlike shapes and weight is that they be placed at unequal distances from the imaginary center of support. In other words, a small object placed a greater distance from the center counterbalances a much larger object just as though they were on a pair of scales. A small object of considerable importance and weight can be used to balance effectively a large, but less important object (fig. 12-14).

The mental impression of weight is a factor in determining the relative placement of objects in a scene. Size alone does not determine the weight or value of an object. The tone of the object and placement in the photograph are factors in determining its importance.

## FORMS

In analyzing masterpieces to learn the secret of their effectiveness, some experts found that the parts of the photograph are grouped according to some geometrical form. This finding can prove useful in planning the composition of your photograph; however, you are cautioned against applying it too mechanically. If you use these forms without modification, the resulting photographs are likely to be stilted and dull. The real trick is to use them in such a manner as to hide them partially.

The most important basic forms are as follows: the pyramid (sometimes called the triangle), the circle, the cross, the “L,” the radii and the “S.” All of these forms may be used in composition of material in a vertical plane or in a photograph involving perspective. Combinations of these forms, such as a circle and a cross, may appear in one photograph.

### Pyramid

The pyramid form (fig. 12-15) suggests symmetry, solidity, aspiration or dignity. We see it in religious photographs, in church spires and in portraits with the head as the apex of the triangle.

### Circle

The circle lends itself to flower studies, still life, graceful groups or landscapes timed in trees.

### Cross

The cross composition is found in a sailboat with its reflection in water forming one line and the horizon forming the other.

### “L”

The “L” composition may occur when a tree at one side of the photograph forms an “L” with the horizon line.

### Radii

The radii composition has lines leading into a center, or out from it, as spokes lead to the hub of a wheel.

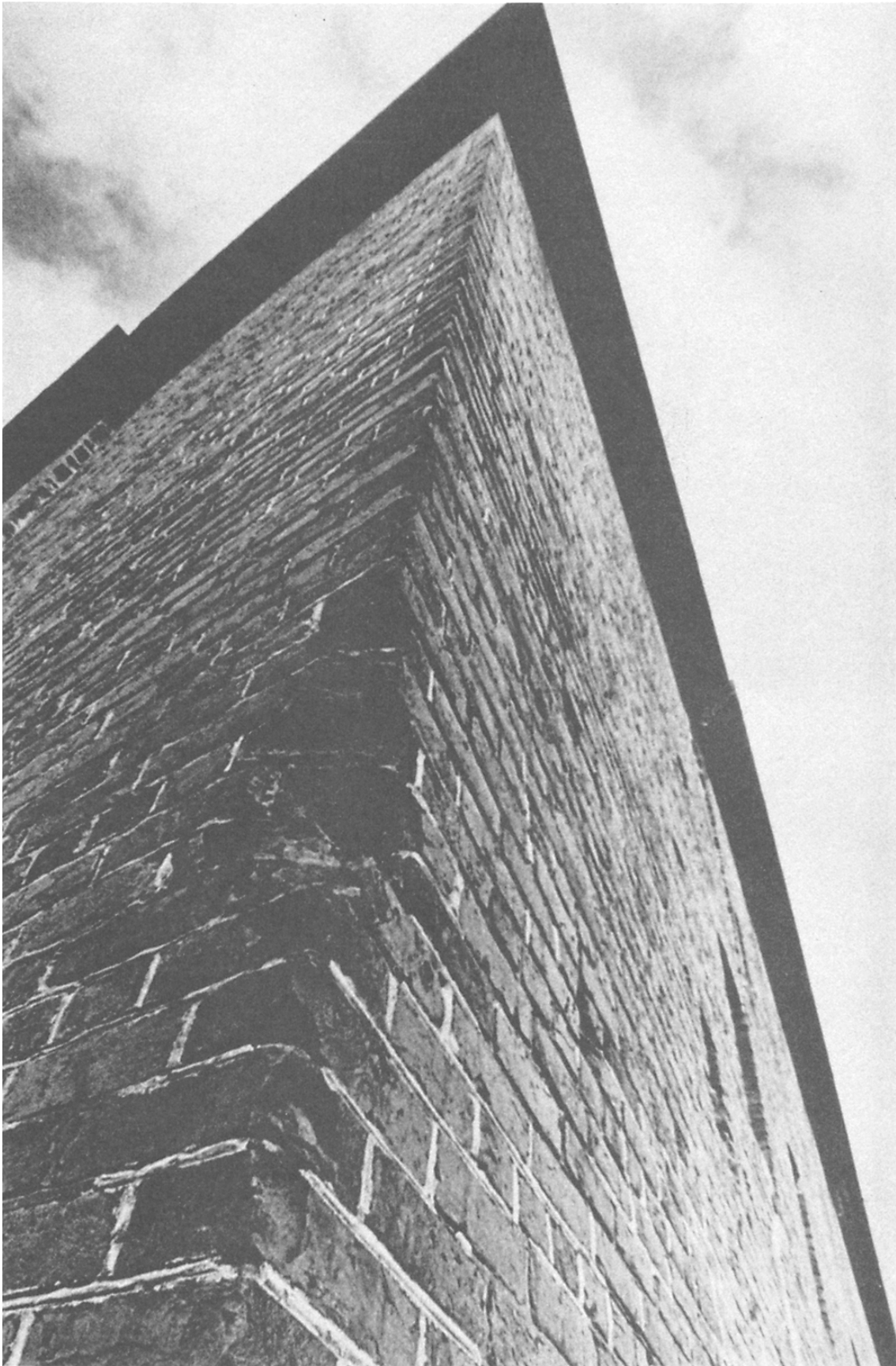

Art Giberson  
165.6

Figure 12-15.—Pyramid form.

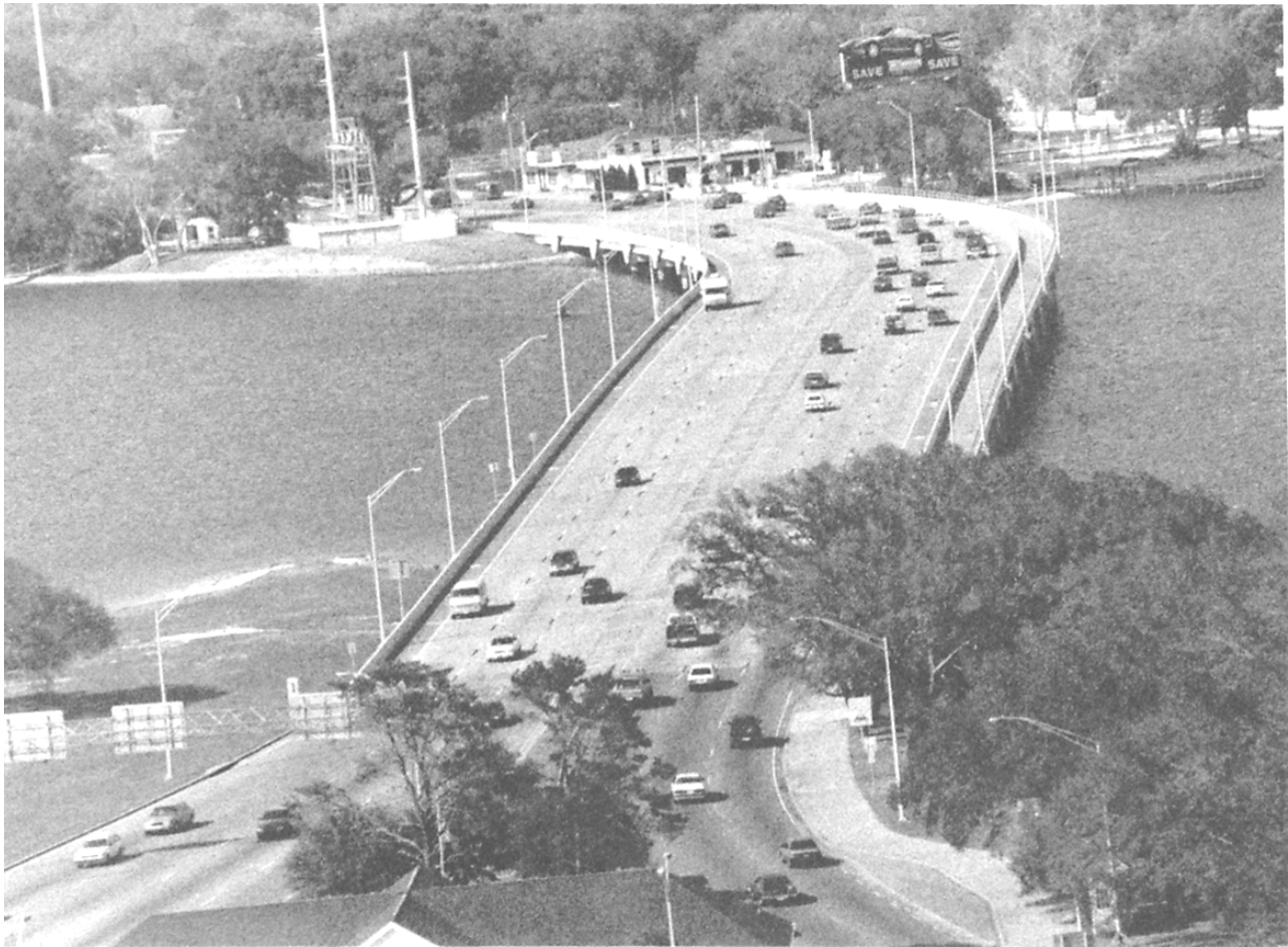

Art Giberson  
165.7

**Figure 12-16.—“S” composition.**

## “S”

The “S” composition, covered earlier as curved lines, is undoubtedly the one photographers use most and the one most popular with viewers (fig. 12-16).

## RHYTHM OR PATTERN

One word often heard in connection with photographs is rhythm. It simply means a repetition of some kind and maybe a shape or a line (fig. 12-17). An illustration in nature is that of a field of wheat, blown by the wind, with each shaft of grain being uniformly bent in the breeze, producing rhythm with changing patterns.

## TONE

Tone refers to the color of each object in a photograph. In black-and-white photography, the gray would run from white through all shades of gray to black

One of the most effective ways of giving impact to the point of interest is to contrast it sharply by color with the other objects in the photograph.

Variations in tones or contrast are important elements in the distribution of weight in a composition. Darker tones create the impression of greater weight. Thus a large light-toned object can be counterbalanced by a smaller dark-toned object. The contrasting tones may be nothing more than shadows or cloud formations. The balancing of equal or unequal tonal areas can be simplified by dividing the photograph space and arranging the objects in opposite thirds of the photograph or at the intersections of the vertical and horizontal lines.

## DEPTH PERCEPTION

As far as the physical characteristics of a photograph are concerned, it has only two dimensions — length and width. Nevertheless, since we are





**Figure 12-17.—Rhythm composition.**

accustomed to viewing nature in three dimensions, it is important that photographs also give the illusion of depth to make them appear more realistic.

The impressions of depth and distance are normally obtained when you mentally compare the relative size of various objects — near objects appearing large and the more distant objects much smaller, even though they are the same physical dimensions. You can easily create the illusion of depth in a photograph by placing common objects in the foreground or background, so the relative sizes of all objects can be determined.

You can also create depth by selecting a camera viewpoint that gives the impression of distance by perspective. This illusion of distance is sometimes enhanced when you exaggerate the perspective by changing the camera position, by using a wide angle lens or by emphasizing texture and modeling through the use of strong sidelighting. Focusing the principal object critically sharp and leaving the background somewhat out of focus usually directs more attention to the subject and tends to increase the feeling of depth. Backlighting the subject gives better separation and makes it appear to stand out more prominently from the background, accentuating the subject and increasing the feeling of depth.

The feeling of depth also can be increased by making the foreground darker in tone than the main point of interest or the background. In some cases, this is done during printing by simply burning in the foreground.



**Figure 12-18.—Good action shot at its peak.**

## ACTION

Action in a photographic composition can be either physical or implied.

In physical action, such as a fleet runner, the motion or position of the runner cannot be held. It changes after the split second in which the photograph is taken.

Action can be implied by a position that suggests a physical action will take place, or it can be facial in which the subject's face suggests or expresses action or a definite emotion.

Good action is shot at its peak as shown in figure 12-18. Where the action is fast-moving, as it is in a sporting event, the peak of action is short and sometimes difficult to determine. To capture this action requires precise timing and know-how. However, in feature development you have the advantage of being able to plan the action logically after studying the job.

## SECURITY AND SAFETY CONSIDERATIONS

Because of the many new technical developments in the Navy, you will probably come in contact with security problems early in your job as a news photographer.

Photographs disclosing pertinent detailed information of a classified nature are to be accorded the same classification as the subject of the photograph. No classified photographs can be released for publication or transmitted by electronic means.

Officers in command status are responsible for taking official or unofficial photographs and for the supervision, censorship and release of photographs. Unofficial photographs taken aboard ship, station or aircraft are either submitted to the CO or a properly designated officer (such as the PAO) for screening to assure that no classified matter is revealed.

The review of photographs must be objective in nature. The prompt release for publication of unclassified photographs of interest to the public and beneficial to the Navy is considered mandatory. Photographs of general naval life, such as ceremonies and athletic events, are not considered to be of a classified nature and should be released automatically. Photographs of doubtful classification for which release is desired must be referred to CHINFO.

Another violation you should be aware of is that of safety. An example is photographing a sailor aboard ship using an electric deck grinder without safety goggles or wearing unauthorized rubber gloves. If you are not sure of the correct safety measures for a given task, ask the command safety officer.

### THE PICTURE STORY

*LEARNING OBJECTIVE: Identify the different types of picture stories and the applicable technical requirements.*

Knowing the detailed techniques for developing a picture story are requirements for senior journalists. However, at the J03 and J02 levels, you should be familiar with the various categories of picture stories.

### TYPES OF PICTURE STORIES

There are seven basic types of picture stories and they are classified as follows:

- Illustrated text
- Photo-text combination
- Pure picture story
- Picture story within text
- Single picture story
- Abstract picture
- Informal portrait

#### Illustrated Text

For this type of picture story, the text or story is written first, then one or more photographs are used to illustrate, or dramatize, its content. In reality, this is not a true picture story, since the photographs are incidental, rather than an integral part of the text. The photographs are used to dress up the page, make it attractive, give it character or establish a mood. Many magazines use the illustrated text format. They frequently introduce each story with a single illustration, full page size, that serves to attract the readers' attention and leads them into reading the story.

#### Photo-Text Combination

As the name indicates, the photo-text combination type of picture story uses a combination of both photographs and text. However, the photographs carry the weight of the story. The story is told primarily by related photographs arranged in some form of continuity. The text is important and provides worthwhile information relative to the photographs, but it is subordinate to the photographs. This is the easiest type of photograph story to develop and the one most commonly used in the Navy.

#### Pure Picture Story

In the pure picture story there is no text except for a brief introduction outline. Of the seven picture story types, the pure picture story is the most difficult to develop. It is frequently presented in sequences of photographs taken at brief intervals. For example, a pure picture story of a VIP's arrival might show the aircraft landing, the disembarkation from the aircraft, handshaking with the greeting party, the inspection of an honor guard and the VIP entering a limousine. Pure picture stories normally are used only when the action

is simple and familiar enough to the average reader so that no lengthy word description is required.

### Picture Story Within Text

The picture story within text actually presents two separate but related stories. One story is told in words, the other in photographs. Both are complete in themselves. The text may be used without the picture story, or the picture story may be used without the text. Nevertheless, the combination of the two in a single layout makes the spread much more effective than either would be alone.

### Single Picture Story

The single picture story is the most basic form of photojournalism. Single photographs, filled with impact, allow the viewer to “feel” the action and thus become involved with the subject.

The single picture story is similar to the lead photograph used in a longer picture story. It sums up the subject, evokes some emotion, or keys the action or the setting. The single picture, while strong, is also simple

Every photographic situation is different so there is no magic formula to tell you how to put impact or strength into a photograph to make it meaningful. Occasionally, the single meaningful picture is simply a matter of luck — being at the right place at the right time. More often, the photograph is the result of careful planning. In either case, the event is only captured because of the photographer’s timing (fig. 12-19). “Timing” means capturing the moment of greatest significance. There is no exact way of predicting that moment. To be successful, you must anticipate what is coming and be ready when it arrives.

### Abstract Picture

You may be objective or subjective in your approach to a subject. This is considered an abstract picture approach. When you use the objective approach, try to record the subject as faithfully as possible, presenting the subject for the viewer’s own interpretation. When your approach is subjective, you engage your own feelings in your work. You approach the subject from the standpoint of your reactions. You want the viewer to

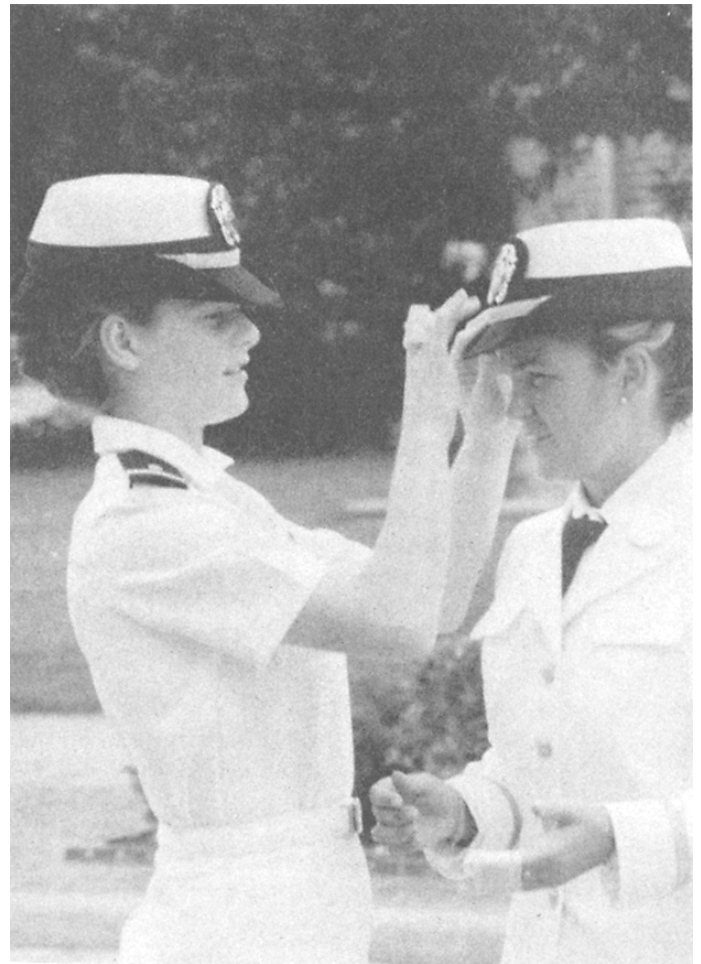

Art Giberson  
165.8

Figure 12-19.—Photograph used in a single picture story.

feel as you felt when you recorded the subject. With this approach, the viewer is handed the reactions of the photographer and sees the subject as the photographer saw it.

It is the subjective approach that must be used to photograph the abstract — thoughts, emotions, and so forth. These are the subjects that primarily involve feelings rather than facts.

A photograph that captures an abstract idea or emotion conveys to viewers something with which they can identify. It stimulates their imagination and causes them to react emotionally.

To sense and capture abstract elements, you must have an understanding of what makes people react. Additionally, you must react yourself. You must see beauty and ugliness, feel love or hate, wonder at the



**Tony Giberson  
165.9**

**Figure 12-20.—Abstract photograph.**



PH2 Ron Garrison

**Figure 12-21.—Informal portrait.**

great and small, and sense and appreciate your own emotions (fig. 12-20).

To communicate the abstract in photographs, you must develop and use your inner sensitivity. The more it is used, the more you photograph will be a successful reflection of your experiences and emotional nature. Plus, the more these elements appear in your work, the more viewers become involved with the photographs.

### **Informal Portrait**

Strong, expressive informal portraits are the result of a successful interaction between the photojournalist and the subject.

The most important element when shooting an informal portrait is for you to convey the character and personality of the subject honestly.

With few exceptions, the informal portrait shot cannot be in a studio where the subject is posing. In this situation the subject may appear very formal and withdrawn.

The informal portrait is best made when the subject is candid. This means photographing the subject in familiar

surroundings, such as his home or place of work. In these surroundings the subject's hands, gestures and facial expressions begin to convey character and personality.

The informal portrait is an excellent medium for relieving the boredom of the plastic formal portraits, the police mug shots and the "grip and grins" in Navy newspapers. If a person is of the caliber or character to be selected "Sailor of the Year," project that character and personality rather than the person's ability to shake hands.

Do not expect to get the best possible informal portraits by taking only two or three photographs. When you start, your subject will very likely be uneasy and tense. However, as you shoot, the subject will usually begin to relax.

The eyes (which must be in sharp focus) and the mouth are the important parts of the informal portrait. They are where the expressions, unique to each person, are revealed. Your job is to coax the expressions out of the subject. Usually, you can do this through a little conversation while you are shooting or by having the subject engaged in work or talking with another person. When the subject becomes involved and forgets the camera, the real expressions begin appearing (fig. 12-21).

There is no strong rule on how much of your subject should be included in your portrait. Ideally, an informal portrait will include everything that relates to the subject and nothing that does not. In some cases, this will mean including parts of the background because it relates to the subject. Or, it will mean throwing everything out of focus except the subject's face. A general rule is to keep the portrait simple and concentrate on the face.

Quite often it will be the available light that is the determining factor for adding depth and mood to the subject. Although formal portrait lighting should be avoided you should master its techniques. This will give you an understanding of the various effects of lighting and the changes they can make to the mood or shape of a subject's face.

The best lenses to use for informal portraits are medium telephotos between 85mm and 105mm. A medium telephoto will minimize the distortion you may get by working too closely with a normal lens, and it will allow you to work at a distance from your subjects that may make them less conscious of the camera.

## **TECHNICAL REQUIREMENTS**

Always keep in mind that the only reason for you to take a news photograph is to get it published. A print suitable for personal viewing may be wholly unsuitable for reproduction in a newspaper or magazine.

Most print media use the halftone reproduction process in which photographs are converted into a pattern of dots. These dots vary in size according to the intensity of the tone they will produce. In light areas, the dots are so small they are almost invisible. In dark areas, the dots are so close together they look like a solid mass of black. The amount of printing ink applied by the dots, of course, is in proportion to the light and shaded areas of the original print.

Because of this factor, photographs intended for reproduction must be clean and bright. The black must be strong enough to withstand a little "watering down." Important halftones in the photograph must be separated clearly, so they will not blend in with each other or become lost altogether in reproduction.

Therefore, a photograph can be good in content and composition, but not usable for reproduction because it is lacking in the following three required technical elements: focus, detail and contrast.

### **Focus**

"Focus," as covered in Chapter 11, means that the subject must be distinct and the image sharply defined. Focus for reproduction must entail extreme sharpness since halftones lose some of their original sharpness in the reproduction process.

### **Detail**

The halftone will not produce fine detail. Small detail in a newspaper is usually lost; therefore, detail must be overemphasized. The most effective way to emphasize detail is to move in close with the camera and concentrate on small areas. Any detail that is important to a photograph should be as large as possible and adequately lighted by natural light or the addition of fill-in reflectors or flash.

### **Contrast**

Contrast is the difference between the light, dark and the intermediate tones of a photograph. A photograph with normal contrast will have an image with a full range of tones from white to black with all the intermediate grays. The image will be boldly defined but will not reproduce well. A photograph low in contrast or "flat" has many intermediate gray tones but lacks clear blacks and whites. It has no brilliance or snap, lacks strength and appears dull. It will reproduce in halftones as an indistinct or "muddy" blur. Only a photograph of normal contrast can be considered usable for halftone reproduction.

## **SPORTS PHOTOGRAPHY**

*LEARNING OBJECTIVE: Identify the techniques used to take sports photographs and record cutline information.*

Sports photojournalists must know the sport they cover inside and out and demonstrate a keen ability to spotlight the key plays and players. While luck helps, more often, anticipation and a good working knowledge of the event are the foundation of a good sports photograph. Sports photography captures action; therefore, you must research the sport before game time in order to understand some of that action and to be prepared for it.

## RESEARCHING THE SPORT

If you have never photographed a particular sport, prepare yourself by conducting research. Go to the library and read upon the sport, and if possible, watch a game or two (either on television or one played by local teams). Understanding basic strategies, rules and plays will help you capture the important moments of the game.

## COVERAGE PLANNING

When you plan photographic coverage of sporting events, you should keep in mind the two main areas of action and people.

### Action

Physical activity is the key ingredient of a sports photograph. Your photograph should not be static — sports action must take place. For instance, in football, the running back might break a tackle, the quarterback release a long pass and the linebacker make a sensational, back-breaking tackle. In baseball, the power forward might take the ball to the rim, the center slam-dunk his points home and the shooting guard drain a three-pointer. In softball/baseball, the extra hitter (designated hitter) could send an 0-2 pitch over the fence, the base runner tag up at second and go to third or the shortstop make a sensational diving stop in the hole.

Regardless of the sport, the point is that you must know and consider the sport you are photographing in order to key in on the action that sells that sport. You must anticipate the action and squeeze the shutter a split second before the receiver catches the football. By anticipating the play, you can capture the reception, rather than what happened immediately after the catch.

Shoot plenty of film when you cover sports. Often a shot you think will be good turns out to be unusable, while one you think you missed will run on the first page of the sports section.

### People

Amateur Navy athletes are personalities within their communities. Your audience enjoys reading about them and seeing their photographs in your newspaper. Because the players are personalities, you should photograph them so they can be recognized in the picture.

The best sports photographs identify key players. “Identifying the players” means presenting the athlete from a profile to full-frontal view, if possible, to show the number on his uniform. A three-quarter to full-frontal view is best but is not always available.

## SPECIAL CONSIDERATIONS FOR POPULAR SPORTS

Each sport has some peculiarities you must consider when you cover it. In the following text are some tips that will help you cover the “big three” sports — softball/baseball, football and basketball.

### Softball/Baseball

If you make the proper arrangements with the base/station sports director, you can take photographs on the field in foul ground. However, as a courtesy, you should still ask the home plate umpire for permission.

Photograph left-handed hitters from the third-base side; conversely, right-handed hitters are best covered from the first-base side. You should shoot right-handed pitchers from the third-base side and left-handed pitchers from the first-base side. In softball, both left- and right-handed pitchers throw the ball while facing home plate, so you can shoot on the other side of the backstop or from directly behind home plate.

Home plate action is best shot from the third-base side of the field. Exercise caution, though. If you get in the way, you will probably be unwelcome at future games.

Get a variety of angles by moving around — go up in the stands, lie on the ground look over a shoulder or use any other creative angle that will not interfere with others.

Because you may need to photograph key plays on the opposite side of the field from where you are standing, be sure to use lenses with a long focal length

### Football

If you are covering your station or base football team, stay on that team’s side of the field and follow the action from that location. (In an assignment where you are covering both teams equally, you may move to the other sideline at the appropriate time.) Move up and down the field with the action and photograph the players as they run, pass, kick tackle and score.

Football photography focuses on the offensive and defensive lines and the star players making or breaking

plays. The end zones provide you with an excellent opportunity to capture plays on both sides of the ball. Since scoring takes place in the end zones, a lot of heated action and exchanges take place inside the 10-yard-line. On the sidelines, bench shots sometimes dramatically tell the winning or losing tale — the frustration painted on a coach's face or the fatigue illustrated in a lineman's slumped body.

Use long, fast lenses to cover football. Additionally, you should also have a wide-angle or normal lens for sideline and goal-line shots.

## **Basketball**

Basketball action normally takes place within 18 feet of the basket. Position yourself near your team's basket so you can capture plays in the "lane."

A 50mm lens is a safe bet for basketball photography. Longer lenses can make for dramatic photographs, but following the action and focusing becomes more difficult. However, you may get good shots by focusing a long lens on the net; then wait for a lay-up or rebound.

"Hoops" is perhaps the most difficult sport to photograph because of the lack of lighting, the fast action and the inability to always predict where the action will take place. To compensate, you should use a high-speed film or an electronic flash unit. Direct flash creates harsh shadows and could blind the athletes, so use a diffused flash.

## **RECORDING CUTLINE INFORMATION**

Sometimes events in a game happen so quickly that you cannot stop to write down cutline information. In this case, it is sometimes wise to shoot the scoreboard, especially after a key play. Doing so can keep you on track if you cannot keep a running caption log to record the time remaining and score when the play occurred. Use time-outs, breaks between innings or other slack times to go back and write down your notes as described in Chapter 9.

## **FORWARDING PHOTOGRAPHS**

*LEARNING OBJECTIVE: Identify the process of handling photographs with historical or news value.*

Whenever a photograph is considered to be of historical or news value, the Navy Imaging Command in Washington, D.C., wants to retain it in the Navy's permanent files (after you have made local use of it). Photographic documentation accomplished by designated photojournalists (NEC-8148) and other photography of significant news value should be forwarded to CHINFO.

Detailed instructions for handling photographs of this nature are covered in the *Navy Visual Information Management and Operations Manual*, OPNAVINST 5290.1 series.



## CHAPTER 13

# RADIO

In the preceding 12 chapters we covered the subjects that comprise roughly two-thirds of the journalist rating — print journalism and photography. Now we will examine the electronic media, beginning with the radio medium.

Although many of the techniques to be addressed also apply to television (Chapter 14), our emphasis in this chapter is on radio and the unique writing, announcing and technical requirements of which you must be aware.

### THE BASIC ELEMENTS OF RADIO

*LEARNING OBJECTIVE: Identify the basic elements of the radio medium.*

To use radio effectively as a Navy journalist, you must remember the following one essential fact and be constantly guided by it: radio is a medium of sound.

While people might hear without trying, they generally do not listen without being stimulated. Consequently, your job will be to stimulate them — to trigger their imagination so they can picture the event being described, a necessity for an attentive radio audience. To do this, you must use one or a combination of the following three basic elements:

- Voice
- Sound
- Music

### VOICE

The most important element of radio is voice, because it is generally the one used specifically to reach the listener with the desired information.

### SOUND

When used on radio, sound must be distinguished easily so the listener is able to interpret the sound and understand what is being conveyed. The roar of a jet engine and the muffled sounds of other flight deck activity will help the listener to visualize the scene.

### MUSIC

Music has a great suggestive power because it plays on human emotion and colors scenes. It touches the heart and mind and sets a desired mood. When properly used, these elements should accomplish the following three distinct purposes:

- Attracting immediate interest
- Maintaining that interest through a particular presentation
- Satisfying the audience's attention and curiosity

### RADIO WRITING TECHNIQUES

*LEARNING OBJECTIVE: Recognize the basic radio writing techniques.*

Radio writing techniques are designed to capture and hold the audience's attention until you have delivered your message. These six techniques are as follows:

- Aural sense appeal
- Rapid getaway
- Power of suggestion
- Pacing and timing
- Freedom of movement
- Conflict

### AURAL SENSE APPEAL

Radio depends entirely on the ear; it must work completely on the listener's mental image inspired by sound waves coming from the radio speaker.

### RAPID GETAWAY

Radio material must capture the attention of the audience within the first few moments of presentation or listeners will be lost. The material must present a challenge, a promise, a suggestion or a conflict to arouse the listener's attention.

## POWER OF SUGGESTION

The human mind is a vast storehouse of scenery. The radio writer suggests to the audience what the scene should be, and listeners — through their mind's eye — can see anything from a pinhole to Waikiki Beach.

## PACING AND TIMING

You must prepare the material for delivery within a definite time frame. Within this timeframe, the changes in quality, emotion, thought or feeling of the material are controlled.

## FREEDOM OF MOVEMENT

As the radio writer, you can take listeners from one point on earth to another, or even into outer space with words, sound effects or the appropriate music.

## CONFLICT

Radio writers call conflict the backbone of interest in radio writing. Conflict is the ageless formula of hero against villain, good against evil, the fight for survival and the solution to difficult problems.

## RADIO NEWSWRITING

*LEARNING OBJECTIVE: Recognize the basic rules of radio newswriting.*

As a Navy journalist your first encounter with radio writing will probably be as a radio newswriter. In that assignment your job will be to meet the deadlines and rigid standards of the electronic media with the Navy's news story.

Radio news style, while dictated by the need for getting and holding the attention of an audience, differs from station to station. It is alive and constantly changing along with the broadcast industry itself.

As with most areas of journalism, there are few absolutes. When scripting broadcast copy, you will face many subjective choices that can only be made by using your own common sense.

The guidelines presented in this chapter are intended to be consistent with the style recommended by The Associated Press and United Press International. However, keep in mind that these guidelines are just that — guidelines. For your copy to serve any worthwhile purpose, it must be the kind of spots and releases the individual radio stations in your geographical area

desire and are able to use. Most local broadcast stations have individual preferences regarding their newscasts and announcements. To be responsive, you must be willing to adapt to those preferences. Study the styles of the stations in your area. If your material does not meet the requirements of the stations you are attempting to serve, then make the necessary modifications.

Initially, be aware that writing for broadcast media is not the same as writing for print media. True, the same rules of accuracy, propriety and good taste apply; nevertheless, there are a number of differences, particularly in writing style. Your job is to tailor each release for the medium that will use it. A release sent to an area newspaper may be turned down by area broadcast stations if it is not rewritten in broadcast style.

Remember that any station is more likely to use your release if it is in a form that does not require the newscasters' reworking. Do not create extra work for the news outlet. This is a fundamental step and should be practiced by every public affairs office.

Broadcast writing is highly personalized — far different from writing for the print media. Broadcast copy is written and designed for the ear. It is personal and has a sense of immediacy. The listener becomes involved and feels as though he is a part of the event being reported.

## THE SIX Cs

In keeping with the requirements previously covered, your broadcast copy must measure up to the following six Cs:

- Clear
- Concise
- Complete
- Conversational
- Current
- Correct

### Clear

Clear copy is written in a simple, easy-to-understand manner. It is developed in a logical way, flows smoothly and is easy for the listener to follow. Even the simplest story may be misunderstood on the basis of one hearing. The listener's attention may be divided between any number of distractions. Therefore,

a radio news story should be perfectly clear to avoid misinterpretation

Avoid jamming too many thoughts or numbers into one sentence. Generally, sentences that are more than 25 words contain more than one thought and should be rewritten into separate sentences. The same principle applies to dependent and independent clauses. They are often very cumbersome, so write them as separate sentences. Commonly accepted literary techniques, unusual words and complex phrases, also tend to obscure sentence meaning and you should avoid the use of such.

In broadcast writing, simple words say it best. Choose words that everyone will understand — the announcer as well as the listener. Do not ignore colorful or descriptive words. However, steer clear of flowery phrases and trite expressions that simply take up time and are of no value. Avoid slang and always translate military, technical, legal and foreign terms into simple language.

### **Concise**

You have concise copy when all unnecessary words have been trimmed away and only those words essential to convey your thoughts remain.

It cannot be overemphasized that broadcast writing is writing for the ear. Listeners do not have the opportunity of “rehearing” your copy, so your sentences should be direct and crystal clear. If your copy is long and involved, you put a strain on the listener and hinder comprehension. This does not mean broadcast writing should be kept at a fifth grade level — but given the choice of being complex or simple, you should choose the latter. Your obligation is to put information into meaningful terms that the “average audience” will understand, and more important, want to hear.

### **Complete**

For the broadcast story to be complete, you must include in it at least four of print journalism’s five “Ws.” Obviously, you will normally state **what** happened in your lead sentence. Then you will tell to **whom** it happened, **when** it happened and **where** it happened. **Why** and **how** generally are not critical, although to be complete, some stories will require this information.

### **Conversational**

Like good conversation, broadcast writing is informal and free-flowing. Write the way you talk. Let the story tell itself. This may sound easy, but it will take

some effort in the beginning. A common pitfall is to write a story as it may have been required for an English composition or a print journalism assignment. Broadcast copy is read aloud by the announcer. It is not read by the listener.

The twofold objective of the conversational tone is that first, it allows the announcer to pick up the drift of the story and second, it makes the copy sound “right” to the audience.

A good broadcast writer “listens” to the story being written. When you have finished writing your copy, take it out of the printer and read it aloud to make sure it sounds conversational. Make sure there are no hard-to-pronounce words or combinations of words that are awkward to the ear. Rid your copy of words that might be unfamiliar to your listeners.

### **Current**

If your story is not current, you do not have “hard” news. News of a perishable nature is usually hard news. If you have a story of immediate news value, you should expedite its completion and delivery to the media. By the same token, if there are new facts or circumstances relevant to your initial release, an update of the initial story should be provided (and marked as an update). This will help ensure currency. It is also helpful if the new or changed elements of the story are identified to reduce possible confusion with information in the original release. You will feel the pressure of meeting deadlines, but remember your credibility is on the line.

### **Correct**

The hallmark of journalism as a writing art — either print or broadcast — is the accurate presentation of facts. Your finished product must correspond accurately with the facts of the story. In the field you will follow every possible lead to get the facts as well as report them.

## **COPY FORMAT**

*LEARNING OBJECTIVE: Recognize the format used in broadcast copy.*

*Normally, when you write copy for radio, you start with a general “what happened” lead followed by a body of significant facts. This body of information does not have to include **all** the facts of the story — only the most important ones. Radio writing is different from newspaper writing, because the most common newspaper lead is the summary lead (using the five Ws*

and H). For radio copy to include the who, what, where, when, why and how in the lead would be too cumbersome. There is no time for nonessential details in radio news items. For the most part, news stories run from 20 to 30 seconds. Spot announcements run from 10 to 60 seconds, and features may run for two or three minutes, depending on the topic.

## THE BEGINNING

The lead sentence must gain the attention of the listeners and orient them on the facts that will follow in the body of the story.

When you begin a story with a person's name or a number, you risk the possibility of that information escaping your listener. Have you ever wished that a newscaster or announcer would repeat something because you either joined the story in progress or did not initially give full attention to what was said? Some writers remedy this by repeating key information later in the story. Unless you are striving for special effect, avoid names and numbers at the start. Do not use an "unknown" name at the beginning. It is much better to say, "A San Diego sailor was cited for heroism today," than to say, "Seaman Phillip Jones was cited for heroism today." Start the story with a general "what happened" lead; then mention the recipient by name.

## NAMES AND TITLES

In the case of names and titles being used together, titles should precede names. It should be "Hialeah Mayor Perfecto Hernandez — not "Perfecto Hernandez, Hialeah Mayor." Alert your listener as to whom you are about to name by prefixing the name with the person's title.

You should refer to federal officeholders by title or as "mister." For example, you would use "President Clinton" or "Mr. Clinton"; "Mr. Gore" or "Vice President Gore"; "Senator Simpson" or "Mr. Simpson."

If a difficult name is unessential, use only the person's title, such as "The Ambassador from Nigeria ..."

## INITIALS

Generally, it is better to omit the middle initial of a person's name unless it is a well-known part of the person's name, such as Howard K Smith, William F. Buckley or John F. Kenedy. The other exception to this rule is when the nature of the story requires further clarification, such as in births or deaths.

## WORDS

In broadcast writing, you must be aware of certain categories of words that are potential trouble areas. These categories are explained in the following text.

### Contractions

In day-to-day conversations, contractions are used rather liberally. Therefore, you should consider using contractions whenever possible because they add to the "conversationality" of your broadcast copy. A definite exception to this rule is the "it will" contraction "it'll," which is awkward when you are trying to read it into a microphone. Additionally, a contraction should not be used when you are intending to stress a particular word or phrase.

### Not

Avoid the use of the word *not* in your copy. "Not" can be dropped out of your copy inadvertently and leave listeners wondering whether they heard "not." Note the following examples:

Examples: <u>USE</u>	<u>AVOID</u>
DISHONEST	NOT HONEST
INNOCENT	NOT GUILTY
FORGOT	DID NOT REMEMBER
IGNORED	DID NOT PAY ATTENTION
UNABLE	NOT ABLE

### Pronouns

There is a danger in using personal pronouns in broadcast copy. When you use "he," "she" or "they," make certain there can be no doubt in the listener's mind to whom you are referring. The ear cannot go back and pick up the identification. Repeat the noun if there may be any question as to whom you are referring.

### Alliterations

Beware of alliterations. When you compose a sentence consisting of several words beginning with the same vowels or consonants, you have an alliteration,

and the announcer has a problem. Note the following examples:

**Examples:** THE WESTERLY WIND  
WHISTLED WILDLY.  
  
THE LOVELY LITTLE LASSES  
LAUGHED LOUDLY.

### Sibilants

Beware of too many sibilants . . . “s” and “sh” sounds. They tend to create a hissing sound when read aloud. Read the following example aloud:

**Example:** THE SIX SOLDIERS STOOD  
SHOULDER TO SHOULDER.

This problem also arises quite often when the apostrophe is used to show possession. Remember, the sibilant makes the announcer sound like a “snake sliding slowly southward”

### Homonyms

Watch out for homonyms — words that sound alike but have different meanings. The ear cannot tell the difference between “won” and “one” or “bear” and “bare.”

### Here and There

Where are “here” and “there” when they are heard by listeners scattered over a wide broadcast area? Make “here” and “there” taboo words when you must refer to a location. “Here,” in reference to a location, can be anywhere it is heard

### Libelous Words

So-called “red flag” words can lead to libel. You should be careful not to mistake “colorful treatment” in your story with words like Marxist, illegitimate, deadbeat, addict, and soon.

### Meaningless Words

When you refer to persons, places or things already mentioned avoid using meaningless words, such as “latter,” “former” and “respectively.” Again, listeners cannot refer back. Likewise, avoid transitional phrases within your stories, such as “meanwhile,” “meantime” and “incidentally.” They are crutches. Each thought, phrase or paragraph should flow to the next with skillful

organization — not with throwaway transitional words. Steer clear of flowery phrases and trite expressions that take up time and space and are of no value. Also avoid slang, vulgarisms and dialects in news writing.

Always translate military jargon and technical, legal and foreign terms into simple language as in the following examples:

<b>Examples:</b> <u>USE</u>	<u>AVOID</u>
ASSIGNED	DETAILED
BEFORE	PRIOR TO
ENLISTMENT	HITCH
IF	IN THE EVENT OF
SAID	CLAIMED
SENT	TRANSMITTED

### Abbreviations and Acronyms

Abbreviations are used in broadcast copy, but only when they are intended to be read as abbreviations. The use of well-known abbreviations is permissible, such as Y-M-C-A, F-B-I, U-S, U-N, A-M, P-M or E-S-T (note hyphens). You may also use MR., MRS., MS. and DR. “ST.” may be used instead of “SAINT,” in cases such as ST. LOUIS or ST. PAUL.

Do not abbreviate the names of military installations. For example, use FORT (not FT.) KNOX and NAVAL AIR STATION (not NAS).

Never abbreviate names of states, cities, countries, political parties (except G-O-P), days of the week, months, titles of officials and address identification, such as street, avenue, drive or boulevard. In addition, avoid starting a sentence with an abbreviation.

A good rule for you to remember when using abbreviations in broadcast copy is — **when in doubt write it out.** Note the following examples:

<b>Examples:</b> <u>WRITE</u>	<u>AVOID</u>
THE SENIOR BALL	THE SR. BALL
RALPH SMITH JUNIOR	RALPH SMITH JR.

CAPTAIN KIDNEY	CAPT. KIDNEY
AIRMAN HOMEY	AN HOMEY
SPECIALIST FIVE HILL	SP5 HILL
SEAMAN TURGEON	SN TURGEON
CHIEF PETTY OFFICER OTTO	CPO OTTO
PETTY OFFICER TINAI	PO TINAI
RADIO STATION W-I-N-E	RADIO STATION WINE
WORLD WAR TWO	WORLD WAR II OR WWII
80 MILES AN HOUR	80 M.P.H. OR 80 M-P-H
HAWAII	HI

When you use an unfamiliar abbreviation or acronym that will be pronounced as a word, be sure to spell it out in the first usage. The following example applies:

**Example:** THE NAVY'S CHIEF OF INFORMATION — COMMONLY CALLED CHINFO . . .

### Phonetic Spelling

If you are concerned about mispronouncing names and places, you can limit the possibility by writing a phonetic spelling of the word in parentheses immediately following the troublesome word. You are the author of the release and thus the “authority” for pronunciation of all names and places in the story. Study the following example:

**Example:** CAPTAIN ANTOINE (AN-TWAN) SPOKE TODAY . . .

Make sure the phonetic spelling appears on the same line as the word it represents.

## NUMBERS

Numbers present special problems to the broadcast writer. For the sake of clarity, broadcasters have developed their own style with numbers. Any number that begins a sentence is always written out.

### From One to Nine

For broadcast copy, write out the numbers from ONE to NINE. Exceptions: Sport scores, time (hours, minutes, etc.), dates, addresses, telephone numbers and license numbers.

### From 10 to 999

Use numerals for numbers 10 through 999. **Examples:** 12, 45, 893, 250, 999.

### Thousand, Million, Billion

Borrow from both styles and substitute words for zeroes. **Examples:** ONE-THOUSAND, 15-HUNDRED, 150-BILLION, TWO-TRILLION.

### Conversational Numbers

Make numbers conversational. Round out figures unless the exact figure is essential to your story. For example, \$1,527 would become 15-HUNDRED DOLLARS. However, exact numbers must be used if your story deals with deaths or other subjects requiring exact statistics.

### Dates

Write dates as OCTOBER 1ST, 2ND, 3RD, 4TH and 31ST, and use four digit numerals for years, such as 1979 or 1994.

Additional examples of using numbers in broadcast copy are shown in figure 13-1.

## STRUCTURE OF BROADCAST COPY

*LEARNING OBJECTIVE: Recognize the structure of broadcast copy.*

Broadcast writing, like other styles of writing, can only be learned through experience. Consequently, writing experience can only be gained by writing, writing and more writing.

	<u>WRITE</u>	<u>AVOID</u>
<b>Money</b>	10-THOUSAND DOLLARS	\$10,000.00
<b>Fractions</b>	TWOTHIRDS FIVE-TENTHS ONE AND SEVEN-EIGHTS	2/3's 0 5 1 7/8's
<b>Percentages</b>	SIX PERCENT ONE-TENTH OF A PERCENT	6% .1%
<b>Address</b>	4951 WEST 14TH LANE	4951 W. 14 LN.
<b>Telephone Number</b>	555-1212	5-5-5-1-2-1-2
<b>Ages</b>	12-YEAR-OLD MARY SMITH	MARY SMITH, 12
<b>Time</b>	10:30 THIS MORNING 10:30 A-M  6 O'CLOCK THIS EVENING or 6 P-M	10:30 A.M. 1030 HOURS  6:00 PM.
<b>Decimals</b>	11-POINT-25 or 11-POINT-TWO-FIVE or 11 AND A QUARTER  SIX-POINT-FIVE or SIX AND A HALF  12-POINT-FIVE or 12 AND A HALF	11.25  6.5  12.5
<b>Roman Numerals</b>	LOUIS THE 16TH POPE JOHN PAUL THE THIRD	LOUIS XVI POPE JOHN PAUL III
<b>Ratings</b>	THE NUMBER ONE TEAM	#1 TEAM
<b>Scores</b>	9 TO 4 23 TO 6	NINE TO FOUR 23 TO SIX
<b>Odds</b>	THREE-TO-ONE	3-1 or 3:1
<b>License Plates</b>	H-L-S 121	HLS-121
<b>Military Units</b>	SECOND FLEET	2ND FLEET
<b>Height</b>	FIVE-FEET-FIVE-INCHES	5 FT. 5 IN. or 5-5

Figure 13-1.—Using numbers in broadcast copy.

That is not to say there is nothing you can do in the meantime. To the contrary, there is plenty you can do to prepare yourself for success in this challenging field.

As an aspiring broadcast writer, you should study, carefully, examples of good broadcast writing. In addition, as you begin to write, remember the principles and techniques covered on the following pages.

Writing for the ear can be tricky business. Reducing a complicated issue or concept into shorter and simpler terms is required of a good broadcast writer.

The most successful broadcast writers write the way people talk in their daily conversations. They write as if they were telling the story to a friend. As an experiment, start noticing the lengths of sentences used in normal

conversation. You will even find that we do not always talk in complete sentences. Quite often we speak in fragments, especially if everyone engaged in the conversation is familiar with the subject matter.

Nevertheless, do not get too carried away with this idea. While the strict grammatical rules we have used during years of education might not have a direct application to broadcast writing, they are still valuable. Verb tense agreement and subject-verb agreement, in particular, are still important, especially for the sake of clarity.

## PRESENT TENSE

Since broadcasters report events as they happen, the present tense is the natural tense. Using the present tense in broadcast news gives the copy an air of immediacy and it gives the listener a sense of participation. However, the verb tense that is most natural to a situation will be the most effective. Every story does not have to sound as if it happened the moment before the newscaster went on the air.

## ACTIVE VOICE

Write your broadcast copy in the active voice. The active voice will help you tell your story more quickly and effectively. It also gives the story a sense of immediacy. Active voice provides impact, which is extremely important to a competitive broadcaster. On the other hand, the use of passive voice normally weakens the impact of a sentence. Look at the following example:

**Example:** THE MILITARY POLICEWOMAN  
SEIZED THE EVIDENCE. (Active)

THE EVIDENCE WAS SEIZED BY  
THE MILITARY POLICEWOMAN.  
(Passive)

If you write the copy to sound like old news, then it will probably be treated as no news. Further, writing stories that will be happening far in the future is just as bad.

Do not confuse the active voice with verb tenses. The active voice can apply to past, present and future tenses. Active voice does not necessarily mean the present tense! **Subject-verb-object** is the best indicator of the active voice structure.

## SENTENCE LENGTH

A sure way to improve broadcast copy is to shorten sentence lengths. Long sentences are difficult to understand and are equally difficult for an announcer to read. Remember, the announcer has to breathe! Further, the announcer's ability to breathe naturally will directly affect the pace and phrasing of the story. Again, the sentence has to sound natural. A good average length for broadcast sentences is 20 words. Do not go over 25 words. This is not a magic number, but it does work. Sentences longer than this tend to be saddled with unnecessary clauses or multiple thoughts. More often than not, those additional clauses can be treated as independent phrases. Broadcast sentences starting with "and," "but" or "because," for example, are perfectly acceptable as long as they sound natural.

You should vary the length of sentences also. Do not peg your sentences to that 20-word mark. Try to mix lengths. If all the sentences are the same length, the copy becomes very stilted and sounds like a laundry list. When possible, give the copy a little rhythm, a natural flow that approximates a conversation. The end result of proper sentence lengths is broadcast copy that stands a better chance of being understood by the audience.

## THE LEAD

As stated earlier, the most important sentence in your broadcast copy is the lead. The lead should grab the listener's attention and set the tone for the rest of the information. Brevity and conciseness play an important part in the lead sentence. The general "what happened" lead is usually the most effective. This lead also can help localize the story. There are several reasons for the "what happened" lead. In broadcast copy, based on the premise of "headline service," there just is not sufficient time for you to deal with all the complexities of a story. Only one or two of the "Ws" might be dealt with at times. Granted, this may sacrifice some of the meaning of the story, but it is also a fact of life. Additionally, the broadcaster is usually working within a given time frame for a story. Some "stories" may be only 10 seconds in length; others may run longer. The copy is not edited by whacking off the last sentence, since the last sentence also is quite important to a broadcaster. The last sentence is often used to make a specific point or as a wrapup.

## QUESTION AND QUOTATION LEADS

Generally, questions and quotations are not used in the lead of hard news stories. Since your listener cannot



see the quotation marks, a quote requires special attention. A question lead, in other than soft news or a feature story, too often sounds like a spot announcement or commercial message.

The rule can be violated if your copy contains a rhetorical question that adds to the attention-getting nature of the lead, as in the following example:

**Example:** HOW COMMON IS THE COMMON COLD? A GROUP OF DOCTORS ARE LOOKING FOR THE ANSWER TO THIS QUESTION.

The same exception to this rule holds true in the use of quotations in a hard news lead, as in the example that follows:

**Example:** “WE WILL BE ON TOP OF INFLATION BY THE END OF THIS QUARTER.” THAT PREDICTION WAS MADE THIS MORNING.

## THE BODY

After writing the lead to your broadcast story, you will develop the specifics of the story logically in the body of your story. Logical development is nothing more than an orderly development of the body of your story so that it flows smoothly to an end. Ask yourself, What is the next thing the listener wants to know?

The body of the broadcast news story can be developed in any one of the following three patterns: chronologically, expanding the Ws and descending importance.

### Chronological Development

In chronological development, you narrate the event from the beginning to its conclusion.

### Expanding the Ws

Specifically identify the who, when, where, and so forth, and further amplify the “what happened.”

### Descending Importance

After explaining “what happened” in the lead, place the facts in order of descending importance. Remember to place the most important facts first.

Avoid placing unnecessary details in the body of your story. Learn to separate the important from the trivial. Often, you will have to condense, to 100 words or less, a story that a newspaper might use as many as 750 words to report.

## Quotations and Attributions

Earlier, we covered the use of quotations in your lead sentence. What about quotations in the body of your story? The same fundamental guidelines apply. Your listener cannot see quotation marks; therefore, you must alert the listener that a quote is coming up.

In the following example, the listener is alerted with “what he called” and “he said” before the quotes.

**Example:** THE SENATOR ATTACKED WHAT HE CALLED “NEEDLESS AND IRRESPONSIBLE USE OF FEDERAL POWERS.” HE SAID, “I BELIEVE THIS IS OUR MOST SERIOUS PROBLEM.”

**QUOTE, UNQUOTE.**— TO lead into quotes by the use of “quote” and “unquote” is disconcerting and unconversational. Avoid the use of long quotes. If it is necessary to link the statement with the speaker, use conversational phrases for this purpose. Consider the following example:

**Example:** THE ADMIRAL WENT ON TO SAY ... CONTINUING HIS REMARKS, THE ADMIRAL SAID.

**DANGLING IDENTIFICATION.**— Generally, you should not start a sentence with a direct quote or paraphrase and tack its source on the end. This is known as a dangling identification or attribution. Remember to alert your listener that a quotation is coming up. Start the quote with the source. Consider the following example:

**Example:**

Correct — PRESIDENT CLINTON SAID, “WE MUST CONTROL INFLATION.”

Incorrect — “WE MUST CONTROL INFLATION,” PRESIDENT CLINTON SAID.

## PUNCTUATION

Unlike punctuation for printed newswriting, punctuation in broadcast writing is used to help the announcer read the copy aloud. For example, a comma tells the announcer to pause, and a hyphen helps the announcer to pronounce difficult words.

### The Period

As in any writing, the period indicates the end of a sentence or thought. More periods are used in broadcast writing because broadcast writing sentences are generally shorter and more conversational.

### The Comma

Use the comma to indicate a pause shorter than that of the period. Do not use a comma unless you want the announcer to pause.

### The Dash

Use the dash to set off appositive and other parenthetical expressions. Consider the following example:

**Example:** NATO — THE NORTH ATLANTIC TREATY ORGANIZATION — VOTED THIS MORNING.

### The Hyphen

Use the hyphen to help announcers in phrasing difficult words and to instruct them on how to pronounce individual elements distinctly. Note the following examples:

**Example:** RE-ADJUSTED, RE-EVALUATE, CO-OPERATE, RE-ALLOCATE, W-C-O-A, F-B-I, Y-M-C-A

### The Dots

Occasionally, you can use a series of three dots to indicate a pause longer than that of a comma. The series of three dots can also be used for a dramatic effect. Consider the following example:

**Example:** THE JURY FOREMAN ANNOUNCED IN A CLEAR FIRM VOICE . . . “INNOCENT!”

## Parentheses

Normally, in broadcast copy, the material inside parentheses is not meant to be read aloud. Parenthetical material in broadcast copy includes notes to the announcer, such as pronunciation guides, reading rates, and so forth.

## Quotation Marks

Quotation marks often will appear in broadcast copy as a cue to the announcer or newscaster to stress a particular word or phrase, setting it apart from the rest of the sentence. Do not confuse the use of quotation marks as a cuing device with their use for indicating a direct quote. Quotation marks also can be used as an aid to announcers to set off nicknames, titles of books and plays, and so forth. Note the following example:

**Example:** THE SQUADRON — BETTER KNOWN AS THE ‘FLYING BLUE DEVILS’ — BEGINS ITS SIX-MONTH DEPLOYMENT TODAY

## MECHANICS OF BROADCAST WRITING

*LEARNING OBJECTIVE: Identify the mechanics of broadcast writing.*

There is more to a successful broadcast news release than a good news peg or interesting story topic. Your release may not even reach the news director’s desk if it does not comply with the mechanics of broadcast writing.

When we speak of broadcast writing mechanics, we are referring to all aspects of a news release, other than the actual content of the story. We speak of a basic format and style used by both commercial and military broadcasters.

Your compliance with a few basic rules assures a better chance for your release to make the airwaves and, in turn, tells the recipient of your story that he or she is dealing with a conscientious broadcast journalist.

Always treat a release from your office as official correspondence. You are responsible for the information it contains. In the broadcast copy, you should include all

the facts necessary for the release to be understood and include all administrative information, such as points of contact and release numbers.

Stations will not accept or use sloppy copy. Your broadcast releases should be error-free. Since broadcast copy is designed to be read aloud, it should not appear to be cluttered. Make sure there is sufficient white space, and always type your script double-spaced. Double-spaced copy is not only easier to read but it also provides space for additional information the announcer might want to insert.

## **UPPERCASE VS. LOWERCASE STYLE**

Broadcast copy can be written (typed) in all capital letters or uppercase and lowercase. There are merits for each style. We are used to reading in uppercase and lowercase, and the patterns of words are easier to distinguish. If both uppercase and lowercase are used, you can also use caps for emphasis. However, the wire services use all caps and the all-capital treatment would conform to that style. Your job is to determine the best style for your releases and use it. Sticking to one style only, within the context of a story, also is important. Be consistent!

## **TYPING COPY**

When typing broadcast copy, you should set your typewriter/printer margin for an average of 60 spaces per line. This will give you about 10 words per line and will aid you in quickly determining how much copy you have written or need to write. Two to four lines will equal about 10 seconds of copy. Seven to eight lines will yield approximately 30 seconds, and 14 to 16 lines will average about 60 seconds.

Since the size of the print influences readability, your releases should be in 10- or 12-point type.

## **TIMING**

Timing in newscasts is also very important. Many radio stations run a five-minute newscast on the hour. By the time all the spots, jingles and introductions are weeded out, there is precious little time for news. Tenor 15 seconds in story length can make a difference in whether or not your release will be aired. Your release should be timed, and the time required to read your release should be indicated on the release.

The average announcer reads at a rate of 2 1/2 words per second. Simple multiplication shows a 10-second release averages 25 words and a 60-second story averages 150 words. Remember — we are referring to

an “average” announcer; naturally, there are many variables. Radio DJs usually read faster than radio newscasters, and radio newscasters usually read faster than television newscasters.

## **PARAGRAPHING**

Do not indent sentences in broadcast copy. It is a waste of space when writing on only half a page. Paragraphing is not used in broadcast writing, since the treatment of a topic can usually be handled in one paragraph anyway. Always set margins flush-left, so your copy will appear as one block.

Consequently, you should not hyphenate or divide a word at the end of a line. If the whole word does not fit, simply drop down to the next line. Likewise, do not split a sentence between pages in your broadcast story. It makes it difficult for the announcer to maintain continuity.

## **NUMBERING PAGES**

If your broadcast story is more than one page, number the pages consecutively. For example, if your copy is three pages long, number the first page 1 of 3, and the last page 3 of 3. Write page numbers in the upper left-hand corner of the page.

## **(MORE)**

When a story takes more than one page, center the word (MORE) under the manuscript portion at the end of each continued page.

## **THE END**

Indicate the end of your broadcast copy by centering three number symbols (###) under your manuscript column.

## **ADMINISTRATIVE INFORMATION FOR BROADCAST RELEASES**

*LEARNING OBJECTIVE: Identify the administrative information required on broadcast scripts released to the media.*

For obvious reasons, it is necessary for you to identify yourself and your organization on broadcast releases. You should also include a telephone number in case the civilian broadcaster needs to ask any questions relative to the story.

## FOUR-UNIT HEADING

Each broadcast script will have a four-unit heading, located below the administrative information but above the actual story matter. Though not read aloud, this heading tells at a glance the basic information the broadcaster requires in scheduling your story for a newscast. The four-unit heading contains the following components:

- **Slugline.** The slugline serves as a title or headline of the story.
- **Date.** The date on the script is the date of its release.
- **Copy length.** The copy length tells the recipient how long it will take to read your broadcast copy.
- **Release line.** The release line indicates the type of broadcast release (covered in the following text).

## RELEASE LINES

All items submitted to radio stations should contain specific release information. One of the following release methods is recommended:

- **FOR IMMEDIATE RELEASE.** Use on hard news items.
- **FOR GENERAL RELEASE.** Use on soft news, features or spots that do not require immediate airing before its value is lost.
- **DO NOT USE AFTER (Time and Date).** Use on spots or news items about events that run for a limited time.
- **HOLD FOR RELEASE UNTIL (Time and Date).** Use on advance releases.

Figure 13-2 is an example of a completed radio news release.

<b>PUBLIC AFFAIRS OFFICE</b>	<b>TELEPHONE: (904) 456-5070</b>
<b>NAVAL AIR STATION SAMARA</b>	<b>456-5071</b>
<b>POINT KENT, FLORIDA 32505-5484</b>	<b>DSN: 922-5070</b>
	<b>FAX: 456-5072</b>
<b>FOR FURTHER INFORMATION, CONTACT:</b>	<b>LCDR LEE MAZZILLI (PAO)</b>
	<b>JO1(AW) JUAN AGUSTO (APAO)</b>
<b>OFFICIAL NEWS RELEASE</b>	
<b>(FOR RADIO)</b>	
<b>PAGE <u>1</u> OF <u>1</u></b>	
<b>PROGRAM <u>75</u> (WORD COUNT)</b>	<b>RELEASE NO. <u>36-94</u></b>
<b>SAMARA HELICOPTER CRASH</b>	
<b>KILLS FOUR (Slugline)</b>	<b>(Release Date) July 21,1994</b>
<b>30 SECONDS (Copy Length)</b>	<b>(Release Line) FOR IMMEDIATE RELEASE</b>
<p>A MILITARY HELICOPTER CRASHED TODAY AFTER TAKING OFF FROM NAVAL AIR STATION SAMARA, KILLING ALL FOUR CREW MEMBERS ABOARD. THE S-H THREE-H "SEA KING," ASSIGNED TO HELICOPTER COMBAT SUPPORT SQUADRON 297, WAS EN ROUTE TO A TRAINING EXERCISE ABOARD THE AIRCRAFT CARRIER U-S-S QUERINO (KAY-RINO) WHEN IT WENT DOWN AT THE NORTH END OF THE MAIN RUNWAY. THE NAMES OF THE DEAD ARE BEING WITHHELD PENDING THE NOTIFICATION OF RELATIVES. THE NAVY IS INVESTIGATING THE CRASH.</p>	
###	

Figure 13-2.—Completed radio news release.

## EDITING BROADCAST COPY

*LEARNING OBJECTIVE: Identify the method of editing broadcast copy.*

Unlike print journalism, in which copy usually passes through several reviewers, broadcasters do not usually exercise that type of control. Depending on the deadlines of the broadcast facility, they might rewrite your release entirely. On the other hand, the local newscaster could simply adopt the old “rip and read” policy and read your release “cold.” Naturally, the second method does not speak too highly of the news staff, but unfortunately, some commercial and military broadcasters continue to do this.

Absolutely clean copy — free of mistakes — is the rule for copy prepared for release to radio stations. Sloppy copy is disconcerting to any announcer.

For in-house productions, editing marks may be used sparingly, but only those editing marks easily understood by an announcer are acceptable. Do not use print media copy-editing marks. Use only the broadcast editing methods covered in the following text:

- **Correct misspellings** by blackening out the misspelled word completely and printing or typing in the correct version above it. Do not attempt to correct a letter within a word. Broadcast copy has no editing mark to correct a single letter within a word. Rewrite the entire correct word as in the following example:

  
EXAMPLE: THE SHIPS [REDACTED] IN HEAVY FOG.

- **Insert words or phrases** by printing or typing the desired words above the line and indicate the point of insertion. Note the following example:

  
EXAMPLE: ...LARGE QUANTITIES OF SUPPLIES...

- **Separate run-together words** by using a single line, as shown in the following example:

EXAMPLE: THE FIRE STARTED ~~IN~~ THE ENGINE. . .

- **Delete a word** by blackening out the word and bridging the gap. Consider the following example:

EXAMPLE: THE TEAM [REDACTED] APPEARED. . . .

- **Delete words on more than one line** by using a curved line to reconnect, as shown in the following example:

EXAMPLE: THE BOSTON SAILOR [REDACTED]  
[REDACTED] RECEIVED A FULL PARDON.

## SPOT ANNOUNCEMENTS

*LEARNING OBJECTIVE: Identify the two types of radio spot announcements and recognize the techniques used in writing them.*

The sustaining point of a commercial radio station is the commercial. Although neither the Navy nor the Armed Forces Radio and Television Service (AFRTS) use them, commercials have a valuable counterpart in Navy public affairs. That counterpart is the spot announcement. Figure 13-3 shows a basic spot announcement format.

Spot announcements are usually 60 seconds or less and come in two forms — the selling spot and information spot. Both are covered in the following text.

### SELLING SPOT

The selling spot is designed to make the listeners take some type of action as a result of the ideas you present to them. The spot also can be used to change attitudes. Examples of these are “Be there!,” “Do it now!” and “See your recruiter today.”

There are many ways for you to structure the selling spot. One way is the three-pronged approach — **attention, appeal** and **action**. First, you form your basic idea and attention-getting lead sentence. Then you present the merits, advantages and appeal of the idea. Finally, you motivate your listener to take action to gain the benefits you were promoting in the spot announcement.

## Attention

A lead such as “Now you can lose weight while sleeping!” is almost an automatic attention-getter for a large segment of your listening audience. This type of lead draws the listeners into your message by provoking their interest and attention. Copy directed toward emotional and motivational drives is copy that sells and should be slanted toward a particular group that needs a particular product.

Spots selling baby food, for example, are directed at mothers who are concerned with the health of their babies. These spots emphasize the healthful ingredients of the baby food. In the same way, the slant toward a particular group is used by the Navy in recruiting. Such spots are aimed at young people in the age group between 17 to 25, and words, such as security, travel, education, missiles and electronics, are used as attention-getters.

When the attention portion is directed toward the listener’s desires, aspirations, dreams and ambitions, you will take the first step toward getting that individual to listen to the appeal and the action portions of your spot.

## Appeal

“Why don’t you begin to enjoy the finer things in life?” You have probably heard that appeal in one form or another. In the appeal portion, you present the selling material — the message you want to convey to the audience. One thing for you to remember is to avoid cramming too many points into a short announcement. Keep it simple and stay with the subject.

For example, if you start off talking about travel as the attention-getter in a recruiting spot, do not drift off into education or some other subject in the same announcement. Another word of caution — do not

**PUBLIC AFFAIRS OFFICE  
NAVAL AIR STATION SAMARA  
POINT KENT, FLORIDA 32505-5484**

**TELEPHONE: (904) 456-5070  
456-5071  
DSN: 922-5070  
FAX: 456-5072**

**FOR FURTHER INFORMATION, CONTACT:**

**LCDR LEE MAZZILLI (PAO)  
JO1(AW) JUAN AGUSTO (APAO)**

**OFFICIAL NEWS RELEASE  
(FOR RADIO)**

**PAGE 1 OF 1**

**PROGRAM 76 WORDS**

**RELEASE NO. 54-94**

**RADIO SPOT FORMAT**

**September 4, 1994**

**30 SECONDS**

**FOR GENERAL RELEASE**

AMERICANS HAVE GROWN UP WITH COMMERCIALS AND SPOT ANNOUNCEMENTS. THE “SELLING” SPOT INFORMS THE LISTENER, THEN TELLS HIM TO DO SOMETHING. THE “INFORMATION” SPOT SIMPLY INFORMS. THE SELLING SPOT HAS THREE STEPS...ATTENTION, APPEAL AND ACTION. THE INFORMATION SPOT USES ONLY ATTENTION AND APPEAL. THE ACTION STEP IS WHERE YOU TELL THE LISTENER TO DO SOMETHING. IT CONTAINS SIX WORDS OR LESS. NONE OF THE OTHER SENTENCES...IN EITHER SPOT...SHOULD BE MORE THAN 15 WORDS.

**###**

Figure 13-3.—Spot announcement format.

promise the impossible. Be sincere and honest with your audience.

**Action**

“Buy U.S. Savings Bonds each payday.”

“Learn how you can travel the world with the U.S. Navy.”

These statements invite action and tell the listeners what they can do. The action step gives the listener a definite course to follow. The step should be forceful, combining invitation and demand, and it should compel the listener toward a positive action. Remember, the action step is designed to motivate the listener to buy, join, write or perform according to the action you have suggested in the message.

The success of any spot announcement as a selling device is measured by the listener’s response to the product advertised. Figure 13-4 shows an example of a selling spot announcement.

**INFORMATION SPOT**

The information spot is designed purely to inform. In this type of announcement, you are not trying to get the audience to do anything or to change attitudes. You simply want to give them information.

The information spot differs from the selling spot in purpose and structure. In writing the information spot, you begin with **attention** and follow it with **appeal**. Because no response is desired from the audience, you have no need for an action step. Your job is to compose the message in a clear, concise form and to get the maximum amount of interesting information into the brief 10, 20, 30 and 60 seconds

<b>PUBLIC AFFAIRS OFFICE</b>	<b>TELEPHONE: (904) 456-5070</b>
<b>NAVAL AIR STATION SAMARA</b>	<b>456-5071</b>
<b>POINT KENT, FLORIDA 32505-5484</b>	<b>DSN: 922-5070</b>
	<b>FAX: 456-5072</b>
<b>FOR FURTHER INFORMATION, CONTACT:</b>	<b>LCDR LEE MAZZILLI (PAO)</b>
	<b>JO1(AW) JUAN AGUSTO (APAO)</b>
<b>OFFICIAL NEWS RELEASE</b>	
<b>(FOR RADIO)</b>	
<b>PAGE <u>1</u> OF <u>1</u></b>	
<b>PROGRAM <u>76</u> WORDS</b>	<b>RELEASE NO. <u>59-94</u></b>
<b>AIR SHOW</b>	<b>November 9,1994</b>
<b>30 SECONDS</b>	<b>FOR GENERAL RELEASE</b>
	<b>(DO NOT USE AFTER 11 A-M NOVEMBER 14)</b>
<p>TWO SPECTACULAR AIR SHOWS ARE SCHEDULED THIS WEEKEND AT THE SAMARA NAVAL AIR STATION. THE EVENTS ARE BEING STAGED NOVEMBER 13TH AND 14TH AS A SALUTE TO AMERICA’S VETERANS. THE NAVY’S WORLD FAMOUS “BLUE ANGELS” WILL HEADLINE BOTH SHOWS. INTERESTING STATIC DISPLAYS AND EXCITING AERIAL ENTERTAINMENT ARE IN STORE. THAT’S SATURDAY AND SUNDAY AT THE NAVAL AIR SAMARA. THE SHOW BEGINS BOTH DAYS AT NOON...AND ADMISSION IS FREE. COME EARLY AND SEE IT ALL.</p>	
<p>###</p>	

Figure 13-4.—30-second selling spot announcement.

DO YOU KNOW WHAT THE LETTERS U-S-O STAND FOR? THEY STAND FOR THE UNITED SERVICES ORGANIZATION...A GROUP OF HARD WORKING MEN AND WOMEN WHO MAKE A HOME AWAY FROM HOME FOR MEMBERS OF THE MILITARY VOLUNTEER WORKERS MAN THEIR STATIONS ALL OVER THE WORLD IN AN EFFORT TO KEEP MORALE HIGH. NO MATTER HOW NEAR OR FAR FROM HOME...THERE'S ALWAYS A U-S-O CENTER NEARBY. THESE CENTERS OFFER ENTERTAINMENT OF EVERY DESCRIPTION...FROM PING PONG TO FREE BROADWAY SHOWS. THE U-S-O IS INDEED YOUR HOME AWAY FROM HOME.

###

Figure 13-5.—30-second information spot announcement.

you may be allotted. Figure 13-5 shows the information spot announcement.

### SPOT WRITING TECHNIQUES

In writing either a selling or information spot announcement, you should remember the following four techniques that will pay dividends in quality:

1. **Plot the pitch carefully.** Before you put a word on paper, you have to know the type of audience you want to reach. If the audience is in the lower income bracket, gear the spot to the special needs and wants of this group. One approach could be the economic security angle; another is the “get-ahead-in-the-world” appeal. On the other hand, audiences in small rural towns might find the travel theme exciting and interesting. Spot writers must study prospective audiences if they are to be successful at communicating with them.

2. **Look for new target audiences.** Although the stress in writing may be recruiting, you should be prepared to write spots that will sell the public on attending a command public visitation, a parade or a demonstration. These special events appeal to many audiences. Some spots might be directed toward fathers, children, teen-agers or even to mothers in the audience.

3. **Develop a direct, personal writing approach.** Even though the audience may consist of several thousand people, the copy is directed at one person. Make that individual feel that the message is personal. Address the listener in terms of “you,” “you’ve,” “your” Canal “you’re.” Always refer to the listener in singular form and in a friendly manner.

4. **Select words carefully.** Write spots in the active voice with such positive and colorful verbs as follows:

go, see, take, try, get, visit, ask, call, be and buy. Be conversational, but avoid slang. Keep your words simple, and do not try to impress the listener with an extensive vocabulary. Speak to the listener in the language that person knows. You also should avoid special military terms and abbreviations that are unfamiliar to the listener.

### Format and Preparation

Whether you are writing a spot announcement for an NBS detachment or a local commercial station, you should adhere to the following general rules concerning format and preparation:

1. **Follow the appropriate style.** Write your spot following the style guide of the station. A station manager might reject your spot if it is not in the style his announcers are used to reading.

2. **Submit clean copy.** All announcements you submit to radio stations should be free of errors.

3. **Submit the proper number of copies.** Check to see how many copies of an announcement each station needs.

4. **Meet deadlines.** If a station manager asks you to have a spot at the station by a given time, do not miss the deadline. Your violating this rule is the best way for you to keep your copy from ever reaching the airwaves.

### Timing the Spot

Timing is extremely important in spot writing. On commercial stations, you will be competing with other public service agencies for free air time. Naturally, a station can allot only so much time for public service announcements.



If you use music or sound effects in your spot, you must remember to take these into consideration in your timing. A 30-second spot with 10 seconds of sound effects averages four to five lines of copy. A stopwatch will help you in timing spots.

Whenever you write a spot, it is best that you include a “kill date” and cutoff time so the station will know when to stop using it. A spot heard over and over, day after day for along time, soon gets dull and irritating to the listener. Also, if you have a spot telling people to visit your command on Sunday, it would certainly sound ridiculous to hear it the following Monday.

## RADIO ANNOUNCING

*LEARNING OBJECTIVE: Identify the techniques used in radio announcing in terms of preparing and delivering copy, and the responsibilities of the announcer.*

Some Navy broadcasters forget that their primary responsibility is to communicate. It is essential that you, the announcer, know what the stories are about before you try to read them on the air. Announcers who only read words are doing exactly that — reading words and not communicating. Remember — it is not the listener’s responsibility to interpret what is read.

### PREPARING RADIO COPY

There are certain aspects of preparing your radio copy that you must do before you go on the air. These include phrasing and marking your copy.

#### Phrasing

The bulk of the communication process centers on phrasing. People do not talk in words; they speak in phrases. The phrasing process is done during normal conversation, without thought. Beginning newscasters have some trouble transferring this natural process when delivering their copy. The best way to see if your

broadcast copy is divided into phrases is to read the copy aloud. Identify whether the phrases answer one or more of the five Ws and H. If the phrase does not answer one of the five Ws and H, then it is not a complete thought

### Marking Copy

Broadcasters use specific oral punctuation marks to divide their copy into phrases. There is disparity between written punctuation and oral punctuation. English teachers teach written punctuation and follow strict rules of usage. Oral punctuation adds accent and tells the announcer when to breathe, without disrupting the natural flow, phrasing and the importance of a sentence.

As stated earlier, most phrasing problems occur because announcers do not understand what they are reading. They are not breathing at the right time or not marking their copy properly. Most announcers adapt easily to the following system:

/ (The single slash mark means you are to pause and take a short breath.)

Use the single slash as an oral comma, just a short pause in the flow of words from your mouth — not a complete stop like a period.

// (The double slash mark means you are to stop reading and take a deep breath.)

The double slash is an oral period. This is a big stop and is the end of a sentence. This is the time to take a good breath for the next sentence.

/ (The triple slash mark means you are to pause / for emphasis, but do not breathe.)

This mark has nothing to do with breathing. It is just a sign to you, and it means pause for emphasis. You might use it for difficult names, quotes or a number in the copy you know you want to emphasize.

An example of radio copy with oral punctuation marks is shown in figure 13-6.

WASHINGTON INTELLIGENCE SOURCES SAID TODAY THAT TUVALU NOW LEADS THE  
WORLD IN ESPIONAGE ACTIVITIES.// ACCORDING TO AN UNIDENTIFIED STATE  
DEPARTMENT OFFICIAL, / THE SMALL SOUTH PACIFIC ISLAND NATION, / LEAD BY PRIME  
/ MINISTER / JEFFREY TINAI (TIN-EYE), / IS BEHIND SEVERAL RECENT INTELLIGENCE-  
/ GATHERING ACTIVITIES / AT NAVY BASES IN THE FLORIDA PANHANDLE.//

Figure 13-6.—Radio copy with oral punctuation marks.

When you are marking copy, make sure you do not change the meaning or context of the story. However, most stories may be marked in more than one way without changing their meaning. How you mark them will depend on your personal style.

## **DELIVERY**

The way you speak or imply the meaning of a word may change the whole context of that story. You, the announcer, are the most important element in the information process. The fewer barriers introduced in transmitting the information, the clearer the information is received and understood by the receiver or listener.

### **Variety**

The announcer should have a voice that conforms easily to the spirit and intention of the assignment. No matter what the subject or script, the announcer must inform the listeners of his sincere belief in the content and the natural excitement (vitality) of the occasion. All meanings should be clear. Being bored should not detract from natural vitality. All the slight changes in mood and feeling, directed by the words and situation, have to occur as effortlessly as they do in speaking with a close friend. Discreet changes in the voice appear naturally when they are truly felt by the announcer.

The human voice is able to reflect all conceivable traces of mood and meaning. Subtle natural changes in vocal pitch, time, quality and force make this possible. Speech without thoughtful distinction tells only a shade of the full mood and meaning and may express monotony or give inaccurate information to the listener. The announcer should feel the mood and know word meaning if he is to show sincerity in his voice.

### **Articulation**

In conversation, we naturally drop sounds and slur words. The reason for working on articulation is to make the sounds of words clear, so that the announcer may be understood.

Clean articulation is the most difficult aspect of voice and diction. Its intent is not to eliminate accents and regionalities, but to enable the announcer to communicate with everyone.

The following are a few drills and methods for dealing with some common articulation problems.

**MUSHY SOUNDS.**— If your speech sounds sloppy, chances are, you are not opening your mouth enough. Have another person watch you read or use a

mirror. Notice if your lower jaw moves. If it does not, this could be the cause of the problem. Announcers who tuck their chin into their chest to make their voice deeper are creating articulation problems. Read your copy overemphasizing the lip, tongue and chin movement required to make each sound, then reread the copy normally. Keep your script at eye level and keep it up while reading so you cannot tuck in your chin.

The same theory applies to the announcer who does not move his lips. Read the copy, overemphasizing each lip movement, then read your copy again normally.

Another solution for mushy sounds is the “pencil method.” Place a pencil sideways to the back of your mouth and firmly between your teeth. Take your script and slowly read it through, articulating all the words. Then reread your script again normally. This will help you correct any mushy sounds.

**DROPPING SOUNDS.**— The ends and the middle sounds of words are commonly eliminated in speech. You should pronounce carefully each syllable of each word, overstating each sound. Then say the word normally.

**Examples:** stand-ing/standing (not “standin”)  
work-ing/working (not “workin”)  
help-d/helped (not “help”)  
mix-ed/mixed (not “mix”)  
spa-ed/sped (not “speh”)  
tah-t/tot (not “tab”)  
nah-t/not (not “nod”)  
mos-t/most (not “mos”)  
de-vel-op-ment/development (not “development”)  
gov-ern-ment/government (not “govment” or “government”)  
syl-a-ble/syllable (not “sylble”)

**NEW ENGLAND “R”.**— Announcers with this problem change the “R” sound in “car” to an “ah” sound (cah). The “ah” sound is easier to say since it does not involve moving the lips or the tongue. Read several words with “Rs” in them, being careful to hit the “AH UR” sound. Try the following example:

**Example:** Parker parked the car outside the card store.

**SOUTHERN VOWEL DISTORTIONS.**— Some people from the South have a drawl that makes their speech difficult to understand. They hold the vowel (a,

e, i, o, u) sound so long that it slurs into the next sound. For example, “I’m” becomes “Ahhh’m.”

To correct this, clip the sound and make it shorter. Run through the following examples, carefully articulating each sound.

**Examples:** just (not jist)

get (not git)

for (not “fer”): replace the word on your copy with the word four or the number 4)

to (not ta: replace the word on your copy with the word “two”)

style (not “stahl”: I’m going to get just two styles of paper instead of getting the four styles you asked for.)

**THE “S” SOUND.**— The “S” sound is the most difficult sound to correct. The general rule is: do not mess with an “S.” Take the microphone and place it out of the “S” air zone, so when you talk you are talking across the microphone instead of directly into it.

### Rate and Transitions

Changes in the tempo (rate/speed) and the use of pauses (transitions) while speaking are essential to understanding. Normal speech rate varies from 80 to 175 words per minute.

A steady rate of speed will produce monotony. In general, changes of rate help reflect the weight of the issue. Important information is slowed; less important topics may be increased in speed.

As stated earlier, the oral punctuation mark gives the announcer an opportunity to pause. The pause makes the division of thoughts and the segmenting of those thoughts possible. Without the vocal pause, the meaning of the topic would be haphazard and hard, if not impossible, to follow. The oral pause also gives the announcer time to restore his breath supply naturally.

### Authority

Announcers, and in particular news people, require authority in their voices. It is that special something that tells the listener, “What I have to say is important.” Newscasters either have it (authority) or they do not — there is no substitute. In some cases, because of a naturally higher pitch, women newscasters may suffer from authority problems more than men, but it is not a problem unique to women.

The following techniques may help if you are lacking authority in your voice:

- **Take charge.** You must have a thorough understanding of your copy. It is up to the newscaster to tell his audience what it needs to know. You must adopt an attitude of, “This is important — listen to me!”
- **Add volume.** Intensifying your vocal tone to establish a sense of authority may be effective. Try this by standing about 10 feet from a wall. Deliver your copy loud enough so that your voice hits the wall and is reflected back. You do not have to yell, but you should be loud enough to be heard clearly 10 feet away. This is called vocal projection.
- **Monitor your volume.** Have another person stand across the room from you as you read the copy. Every time your volume drops, have that person tell you to speak louder.

### Stumbling

All newscasters occasionally stumble over a word, and they should not worry about it as long as it is only occasional. When you experience a lot of stumbles, the cause is usually the brain getting ahead of the mouth. Here are a few solutions:

- **Concentrate on what you are reading.** Your mind should be on your copy and nothing else. Avoid distractions.
- **Use the index card technique.** If you are a speed reader or read unusually fast, place a 5- by 7-inch index card on the line you are reading. As you come to the end of that line, move the card to the next line. This technique will slow you down enough so you do not overread and it will help you focus your attention on the line you are reading.
- **Use parentheses to mark any phrases that give you trouble.** Do not mark individual words — only mark the phrase.
- **Preread your copy at least twice for familiarization.** If your copy surprises you while you are reading it on the air, you are not ready to read. You should be able to tell, in rough form, what the stories are about without looking at the copy.
- **Avoid back tracking to correct a stumble.** Keep going and do not call attention to the mistake.

Some people worry so much when they make a mistake that they make additional mistakes. Once a mistake is made, **FORGET IT.** Concentrate on what is coming, not what is gone. Your audience does not expect perfection. (One exception to this rule is if the stumble changes a fact in a story. If this happens, take a second or two to regroup, then correct the error. You also can correct the error after a spot break, if time allows.)

- **Have your eyes checked by a doctor.** Unfortunately, eyesight deteriorates with age and even the best announcers cannot read words they cannot see.

### Speedy Delivery

Speaking too fast is a common problem for beginning announcers. As the announcer, you can correct this problem by understanding that not everyone is able to think as fast as you can talk. If the listener cannot understand you because you are speaking too fast, then you are wasting the listener's and your own time.

The following are a few simple tricks that will help you slow your delivery:

- **Write the words *SLOW DOWN* all over the margins of your copy in a bright-colored ink.** This will remind you throughout the newscast to keep your speed under control.
- **Use the three-step reading system.** Read the copy through once, as fast as possible. Then read it as slowly as possible, over-articulating and reading one word at a time. Finally, read the copy somewhere between the two previous speeds. During the third reading, make sure you are in the presence of someone who can tell you to slow down when you start to pick up speed.
- **Follow the "five-minute rule."** The average rate of delivery is 15 lines per minute. The actual rate should be somewhere between 14-16 lines per minute. Limit yourself to 60 lines of copy for a five-minute newscast. Make sure you finish at exactly the five-minute mark. The only way to reach the time mark and not have dead air is to slow down.
- **Use the eraser technique.** Place a medium-sized art eraser between your front teeth. Try to read the copy while holding the eraser firmly in place by biting down. You must articulate and be able to be understood while you are reading. It is

almost impossible to talk fast and still be understood while you are holding the eraser.

- Mark your copy for breathing points. Breathe wherever you see a mark

### ANNOUNCER RESPONSIBILITIES

As you can tell, radio amounting is hard work. The listening audience may associate the word *glamorous* with the broadcast industry, but the fact is — radio (like television) is an exacting business and announcing emphasizes professionalism.

For every announcer who has made it to the "big time" and who has become a celebrity in the civilian world, there are 100 good announcers who, in addition to their on-airtime, perform many other station duties. There are announcers in a lot of small stations who work the audio consoles, write last-minute commercials, rewrite news copy, check equipment and do anything else required of them to make the station work well. This is exactly what will be asked of you as a Navy broadcaster — you must be a **generalist**.

Furthermore, during your on-air experiences, you will realize that an isolated slip or flubbed line is almost inevitable. This is true even for the veteran announcer. However, if you make (too many errors, you will be looking for a new job. The key to success is experience, and a good announcer drills diligently in the never-ending quest for perfection.

### Required Qualities

The qualities usually considered necessary in a professional radio announcer are a good voice, little or no regional accent, clear diction and accurate pronunciation. Quite often, your voice affects the audience's opinions about programs.

A resonant voice, the best diction, and even the best pronunciation will not help the announcer who mechanically reads lines and fails to project a feeling of sincerity. In effect, the announcer must have a good radio personality and make his voice reflect such.

### Adaptability

Your personality is reflected in your voice. If you are not genuine, the listener will take note quickly. Changes throughout the program day make it essential that an announcer be capable of changing his delivery to fit the content and mood of the particular program.

No matter the type of program or its theme, most listeners enjoy hearing a voice that offers friendliness, naturalness, sincerity, integrity and vitality. Announcers, of course, usually seek to work in an area where they

perform best. Some announcers are best at news, some at country and western music, some at rock ‘n’ roll, and soon. In short, you must be like a chameleon. You must be able to conform to the many variations of style that the average broadcast day will demand of you. You should set high standards for voice control, diction and pronunciation; then strive constantly to live up to those standards. This is a never-ending, ever-learning process. However, the satisfaction you will get from being an effective announcer is well worth the effort.

## PRODUCING A RADIO FEATURE

*LEARNING OBJECTIVE: Detail the elements needed to produce a radio feature.*

In radio, you are primarily responsible for all stages of feature production. In commercial radio, particularly in smaller markets, the DJs of the station are responsible for producing features. The same thing applies at NBS detachments. Once you are assigned a production, the entire process, from researching the subject to putting it on tape, belongs to you.

In this section, “radio feature” and “audio production” are used interchangeably.

## SELECTING MUSIC

Music is used to set the mood for a production. It can create a feeling of excitement, tranquility, suspense or sadness. The following four types of music can be used in audio production:

- Theme
- Background
- Bridge
- Fill

### Theme

If you are doing a series of spots on a particular subject or using a particular character, theme music will lend identification to that subject or character. Avoid using familiar songs as themes; for example, “Gonna Fly Now” from the Rocky movie series or the theme from American Gladiators. These selections tend to distract the listener and ultimately lessen the effect of the message.

## Background

Background music helps set the mood of the feature production and it increases audience appeal. A voice-only production can be very boring, especially if it is just one voice. For example, a few strains of dramatic fanfare might heighten listener anticipation of a story climax. Conversely, you could use light, melodic music to support a comical subject. There is instrumental music to fit almost any mood. It is just a matter of listening to the selection, perceiving the emotion or mental image it creates and matching the appropriate mood to your subject.

When you are selecting music for background, instrumentals are preferred over music with vocals. Vocal songs tend to distract the listener from the message of the production. Vocal music may be used, but only if it contributes to the message. When vocals are used, level balance becomes critical so that the music does not override the message.

Background music should be unrecognizable and match the subject. By adding the right background music, you add to the aesthetic appeal of the feature.

## Bridge

Bridge music connects or “bridges” two ideas or thoughts. Bridge music, also called transitional music, was used in radio theater to change the scene. A short instrumental fanfare can signal a change in topics — or, a new scene can be introduced with a short musical theme that suggests a particular location.

## Fill

Fill music is often called “pad” music and is usually an unrecognizable instrumental song. If your feature production is required to be a certain length, you can use fill music to eat up time at the end. This also allows the person airing the production an opportunity to transition to the next program element gracefully with less chance of lapsing into dead air.

## SELECTING SOUND EFFECTS

The use of sound and sound effects works much the same way as music. The purpose of sound effects is to enhance the spoken word.

Creative use of sound can help develop a vivid picture in the mind of the listener. The success of an audio production often depends on the mental picture conjured up by different sound effects. Good examples are the spots produced for the Radio Ad Bureau promoting radio advertising. By using sound effects, the producer created a visual picture in the listener’s mind by doing such things as draining Lake Michigan, filling

it with chocolate and topping it off with a 750-foot mountain of whipped cream and a 10-ton maraschino cherry. This versatility is available for any radio production and is limited only by your imagination and ability to locate or create sound effects.

The following are the three main types of sound in audio production:

- Real
- Simulated
- Rerecorded

### **Real**

Real sound effects are produced in the studio using the actual source, such as papers shuffling or scissors cutting cloth. You are limited to the availability of the particular item to make the desired sound.

### **Simulated**

Simulated sound effects are those that do not recreate reality, but merely suggest it. Crinkling cellophane can suggest a campfire, and running your thumb across the teeth of a comb can suggest casting a fishing line.

### **Prerecorded**

Prerecorded sound effects are those available on tape or compact disc (CD). The two types of these are the ones that create a sound picture, such as a city street or factory, and the ones that create individual sounds, such as footsteps or the opening of a door. When using prerecorded sound effects, you are limited to the recordings available in the tape or CD library of your station.

## **USE OF THE VOICE**

The voice is the essence of most radio productions, because it conveys the message. Each announcer interprets copy according to his style of delivery and the type of delivery needed to communicate the message effectively. Voice characterizations may be used if it is appropriate to the production, but make sure the characterization is realistic and portrayed well.

## **BASIC PRODUCTION CONCEPTS**

There are many ways to put an audio production together. The technique you decide on will depend upon the complexity of the production, the equipment available to you and your ability to put it all together.

Although there are many variations to the process, audio productions usually are formed around the following four basic concepts:

- Beginning to end
- Prerecorded voice
- Prerecorded music and sound effects
- Segmenting

### **Beginning to End**

When you are using this method, everything is done nonstop, mixing all the elements onto tape. This means recording the narration, background music and sound effects at one time, as they are called for in the script. Because this method requires many rehearsals and considerable production skill, it is not recommended for the inexperienced broadcaster.

### **Prerecorded Voice**

If you choose the prerecorded voice method, put one element on an audiotape cartridge (known in the industry as a “cart”) and mix the other elements in as you go. This method is best used for a production that requires only a few supportive elements. The prerecorded element is the narration, allowing you to concentrate on mixing the other effects as they are needed. You can add other elements later.

A disadvantage to this method is that it limits the announcer’s flexibility to interpret the script as it relates to the accompanying music or effects. Therefore, prerecorded voice is not the recommended method of production. It is used sparingly and, generally, only for “straight” copy requiring little interpretation.

### **Prerecorded Music and Sound Effects**

Although time consuming, the prerecorded music and sound effects method works best in a complicated production, especially if the producer is inexperienced. By placing all the elements onto cartridges and then mixing them on a reel-to-reel tape recorder, you can “build” sound elements by layering one element on another using multiple recordings. The possible combinations of cartridge-to-reel, CD-to-cartridge and cartridge-to-cartridge are many. This method also allows the announcer to adapt the vocal mood to the mood created by the other elements.

### **Segmenting**

The segmenting method allows the broadcaster to take manageable portions of the production and produce them using the beginning to end method. These separate segments then can be edited together to form a complete production. This method is good for very long and complicated productions but it requires both editing skill

and production time. For shorter productions, the prerecorded music and sound effects method is recommended.

## **RECORDER AND REPRODUCER SETUP**

Before beginning production, you should make sure all the recorders and reproducers have calibrated levels. Commonly, a 1000-cycle tone is used to set all the VU (volume-units) meters (both in record and reproduce modes) to 100 percent. The tone series as a reference point for aligning the different recorders you maybe using. Most studios have the tone hard-wired into the control board or the control room patch panel. Other production studios have the tone prerecorded on a cartridge.

## **SPECIAL EFFECTS**

In audio production, there are times when an ordinary sound is not enough to convey the message or the intent of the script. Accordingly, you may enhance or change a sound electronically to produce an entirely different effect.

The five most commonly used special effects are as follows:

- Filtering
- Equalization
- Reverb and echo
- Phasing

All of the audio effects covered in this section are produced electronically using studio equipment (except phasing).

### **Filtering**

A filter is an electronic circuit designed to pass only selected frequencies and to eliminate all others. An audio signal filtering device is often built into the control board or wired into the studio patch panel. Using filters, you can reduce the lows and enhance the highs of a microphone signal to simulate a voice coming from a telephone or radio speaker. Filtering is most commonly used during the recording process.

### **Equalization**

Equalization is similar to, but has more exacting results than, filtering. An equalizer is a piece of equipment that alters the frequency response of an audio signal, allowing for the modification of specific portions of the overall signal. In other words, whereas

equalization does not totally eliminate frequencies — it does vary their playback level. You can use an equalizer to match audio originating in-studio with on-location audio by adjusting specific audio frequencies.

Another common use of equalization is to correct acoustical problems that occur at remote recording locations.

### **Reverb and Echo**

The terms *reverb* and *echo* are often used interchangeably, but are two distinctly different sounds. Echo is defined as the repetition of sound and is often achieved by using a reel-to-reel recorder. Reverb is the persistence of sound until it fades away and it is usually achieved by using a cartridge machine. The reason for the difference is the distance between the record and playback heads on the two different types of machines. The heads of a cartridge machine are closer than those of a reel tape machine. The closer the heads, the more persistent or reverberated the sound. The farther apart the heads, the more repetitive the sound, giving an echo effect.

To get either effect, just open up that particular pot (potentiometer) of the machine while you are recording on that same machine. The more you open the pot, the greater the effect. To achieve the echo effect on a reel-to-reel machine, you must set the machine function switches to both playback and record. This is not necessary when using a cartridge machine because it only has a record switch. Of the two effects, reverb can be distorted more easily. Both effects can be overdone to the point that the message cannot be understood. Therefore, you should use these effects with caution.

### **Phasing**

Phasing is that spacey, wavelike sound you sometimes hear on the voice for rock concert promotions. This effect adds depth to the sound and is usually used to enhance the voice. It is achieved when two identical audio sources are played back at slightly different start times.

To get a better idea of what phasing is, try it out for yourself. First, record a piece of copy, then make an identical copy of it on another tape. Record both copies onto a third tape, starting the first two a split second apart. If you start them too far apart, you will have an echo. If you start them too close together, the phase effect will not be pronounced enough.

You can produce other effects in the studio using the speed adjustments on the reel-to-reel machines. You can also edit the audiotape, taking out the pauses in the voice and making it sound as if two different sources were

used for the same voice. Your experimenting with the equipment might even lead to an audio effect that is unique. Let your creativity guide you.

Do not overuse studio effects; they can become tiring to the ear and may cover the intended message of the production. An advantage of radio is that it lends itself to the audience's imagination better than television does. Through the clever use of studio effects and radio sound, you can exploit this advantage to take your listener on a trip to Hawaii while he never leaves his living room.

## **ORGANIZATION**

Organization is the key to making the most of production time. Think the whole process through before you walk into the studio. This will reduce frustration. If you are not prepared and things do not work the way you want them to, frustration sets in and the production becomes that much more difficult.

## **QUALITY CONTROL**

When completed, the production has made a drastic transformation from a producer's imagination, to a script, and finally to a recorded tape or cartridge. Throughout this gradual change, certain internal checks were applied to make a high-quality product according to aesthetical and technical standards commonly recognized by broadcasters and the specific requirements of the local station.

Quality control is the responsibility of every broadcaster and will mean the success or failure of the objectives of the production.

## **PRODUCTION PHASES**

The internal checks and balances previously mentioned come during the following-three phases of the development of the production:

- Reproduction
- Production
- Postproduction

### **Preproduction**

Preproduction is the gathering of all the supporting elements called for in the script and auditioning specific music and sound effect cuts to make sure they are appropriate. Many times, what the scriptwriter envisioned on paper turns out to be inappropriate in the audio production. The music (tempo, key, melody theme) should convey to the listener a mood that

supports and enhances the objective of the production. Your ear is the best judge of whether a piece is aesthetically correct for the production, and it should be obvious if there is a mood mismatch. This is a good time to audition any background music that contains vocals.

There is no absolute rule against using vocal songs as long as it is important to the message and the levels (narration and music) are set correctly. The background music, with or without vocals, is acceptable only if it remains **in the background**. It is easy for the music to end up overpowering the message. Your using vocals for background music means you will have to make a close check on the level balance during the production and postproduction phases.

Check all supportive elements to make sure they meet technical broadcast standards. The script may call for a sound effect that is only available on an old tape that is distorted when played. In that case, find a similar effect on a newer, cleaner tape or create the effect yourself. If actualities from other sources are used (interviews, news inserts, etc.), they also must be produced cleanly and be understood easily.

Review the script and note any unfamiliar words or names. Look up the pronunciations of any that maybe a problem for you. If another voice is called for, make arrangements for someone else to be in the studio at the appointed production date and time and have copies of the script prepared for him.

Furthermore, before you begin the production phase, know and understand the format requirements for your product. In other words, is the final package to be on reel tape or cartridge? What speed should the production master reel be recorded? On what is the timing requirement? When these technical questions have been answered, you are ready to go into the studio.

### **Production**

Once in the studio, make sure all the required equipment is in good working order. Follow the locally established procedures in setting up and checking the audio console and equipment needed for your production. It is best to bulk erase any production tapes you use. Using tapes that still have audio from other productions can make tape cueing difficult and may lead to the unintentional airing of unwanted audio. It is a good idea that you label all tapes used in the production process so you can find the element you need easily.

Follow the script as it was approved. Unless you are the writer, do not make substantial changes to the content without first checking with the author. There may be a good reason for the script appearing as it does.



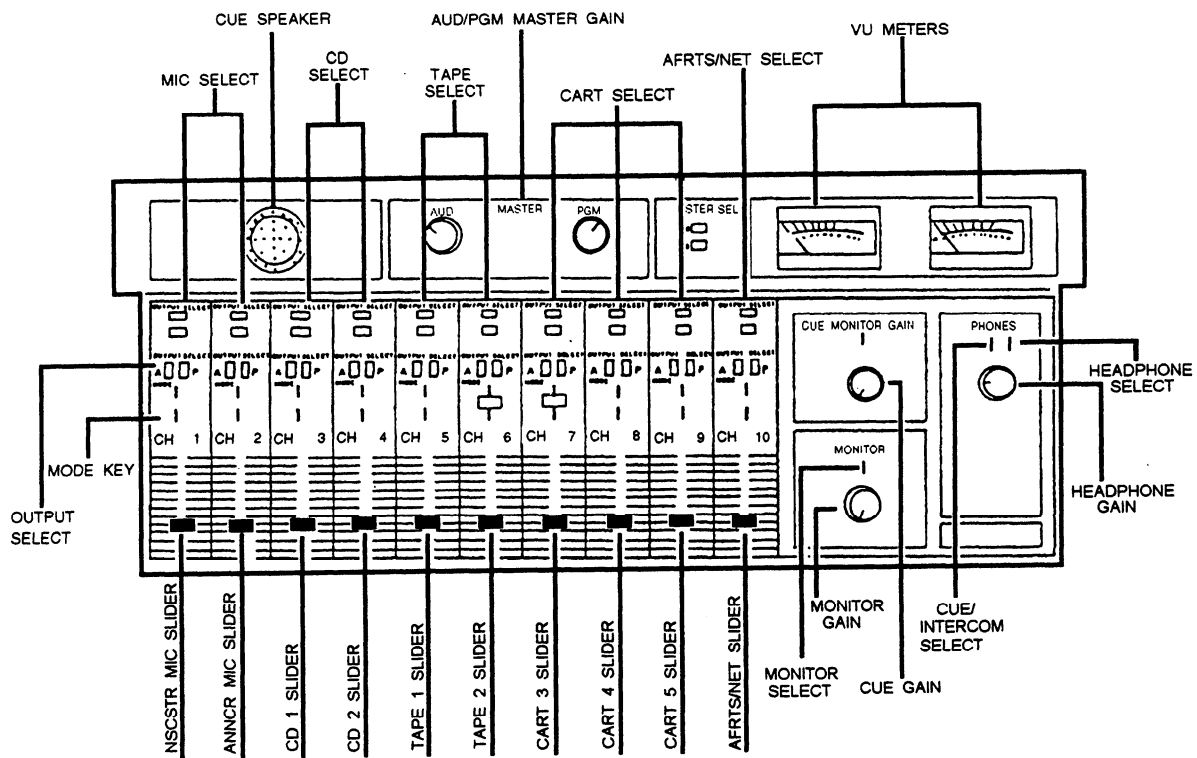

Figure 13-7.—Audio console.

Monitor the record and playback levels constantly during the mixing process. When putting several elements together, listen closely in the headphones to the level balance. Remember, do not let supporting sound override primary audio. Check the master tape recording level to make sure its average peaks are between 80 and 100 percent on the recorder VU meter. If you thoroughly completed the preproduction organization, it will be easy for you to follow the script during the production phase.

### Postproduction

You should listen to the finished product and make sure the production accomplishes its intended purpose. Listen for quality checks you may have missed in earlier development. Pay particular attention to the audio levels and quality of the final recording. If the spot or feature is not satisfactory, mix it again and correct the problem. Check to be sure the production meets the allotted time requirement.

When the final product passes all the quality control checks, label it according to local procedure and turn it over to your supervisor.

## RADIO CONTROL ROOM EQUIPMENT

*LEARNING OBJECTIVE: Identify the equipment in a radio control room.*

Radio broadcasters find out early in their careers that broadcasting involves more than just announcing. Broadcasters working in the radio medium also must be proficient at operating radio control room equipment. In this section, we will cover the various pieces of equipment that make up a radio control room.

### AUDIO CONSOLE

Even though all audio consoles are operated in the same basic manner and perform the same primary functions, their capabilities are not always the same. Differences among consoles are obvious from one model to the next, but even consoles of the same make and model often are locally engineered to perform various additional functions.

Before you operate your console for the first time, take the time to learn its various intricacies. Figure 13-7 shows atypical audio console.

The audio console connects the microphones, cartridge machines, reel-to-reel tape recorders/

reproducers, remote lines, CD players and other audio equipment into one system.

In the following text we describe the controls on the audio console shown in figure 13-7:

- **Microphone selector buttons.** There are two identical controls for the operation of microphones on the audio console (channels one and two).
- **CD selector buttons.** Channels three and four control CD players one and two. Because everything is read from left to right, CD one is selected by depressing selector button number one on channel three. Selector button number two on channel four operates CD two.
- **Reel-to-reel (tape) selector buttons.** Tape one is programmed through selector button number one on channel five and tape two through selector button number two on channel six.
- **Cartridge selector buttons.** Three cartridge machines are programmed through channels seven, eight and nine.
- **AFRTS/network selector buttons.** Channel 10 receives audio originating from the AFRTS Broadcast Center (BC) and major radio networks.
- **Output selector buttons.** All 10 channels on this audio console have the following two output options: audition and program.
- **Mode keys.** This key has three positions. When a sound source is not being used, the key is maintained in the neutral (off) position. Pushing the key up into the audition/program buss places your sound source on the air. Moving the key into the cue position allows you to hear the source only in the studio and not on the air.
- **Cue/intercom selector.** This selector allows you to cue a sound source over the cue speaker or permits broadcasters to communicate between studios.
- **Cue gain control.** This control regulates the volume of the cue speaker.
- **Headphone selector.** This control is used to select the audio source that is heard through the headphones. The three positions are audition, program and cue.

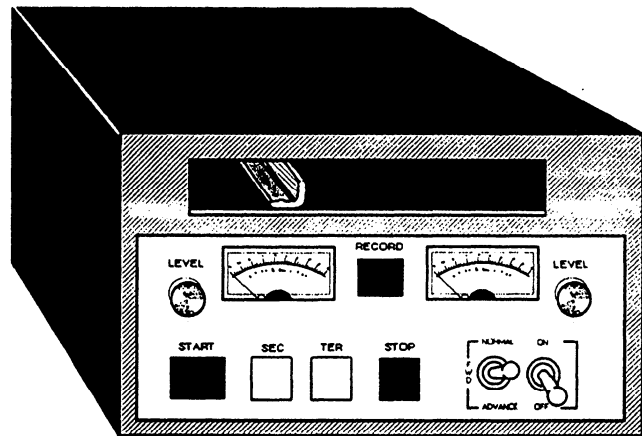
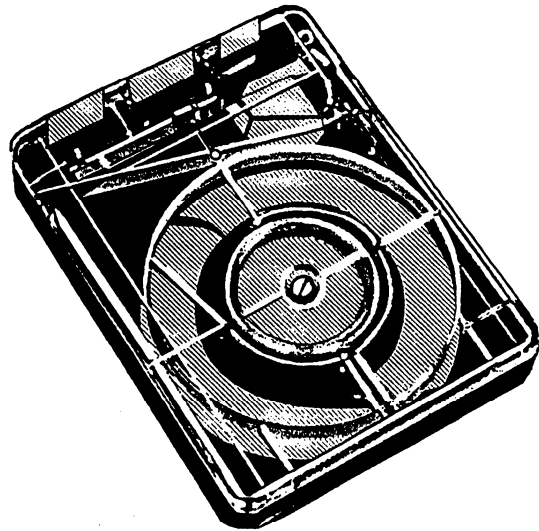

Figure 13-8.—Audiocassette cartridge and cartridge playback machine.

- **Headphone gain control.** The headphone gain control is located immediately below the headphone selector. Set this level to hear your program sound source clearly, but not at a point where sounds within the studio are drowned out.
- **Monitor selector switch.** The monitor selector switch is used to select which audio source is heard on the “air” monitor speakers located in the studio. The three positions are audition, program and air.
- **Monitor gain control.** This control regulates the volume-of the monitor speakers.
- **Audition/program master gain controls. DO NOT ADJUST THESE CONTROLS!** They control the output of the entire audio console and are set by the station engineers.

- **VU meters.** The VU meters give the only visual reference to sound loudness. As described previously, the correct meter readings are achieved” when average music and voice peaks fall between 80 and 100 percent. Allowing the meter to run constantly in the red, known as running “hot:’ can create sound distortion and is never acceptable.

## SLIDERS

Sound sources connected to your audio console are controlled by the use of pots, called sliders. The output selected above the sliders gives you the option of listening to the sound source in audition or program mode. Program is used **only** when a sound source is aired Audition allows you to listen to a sound source to make sure it is properly cued and the appropriate sound levels are set on the VU meter.

## AUDIOTAPE CARTRIDGE AND CARTRIDGE MACHINES

You will use audio tape cartridges and cartridge machines for most of the spot announcements of your station Cartridges come in various lengths, from 10 seconds to five and a half minutes. Inside the plastic casing of the cartridge is a continuous tape loop that provides sound immediately when played. Because the tape must play through before it stops and recues itself at the cue pulse, you should select a cartridge that is slightly longer than the recorded material.

Before you air a spot announcement on cartridge, perform the following steps:

1. Make sure the cartridge is properly seated in the machine.
2. Set the output selector to audition.
3. Start the cartridge and set the output level (using the appropriate slider) on the audition VU meter.
4. Allow the cartridge to play through until it recues.
5. Once the cartridge recues, place the output selector in the program mode. The spot announcement on cartridge is now ready to air.

An audiotape cartridge and cartridge playback machine are shown in figure 13-8.

## CD PLAYER

You will use CD players for production purposes. Commercially, the CD and CD player have replaced records and turntables. This is because CDs are easier to store and their sound quality is superior.

The CD is a 4 3/4-inch plastic platter that is scanned by a laser beam positioned above the disc. Unlike records, CDs do not skip and its 500th play will sound as flawless as its first. However, you should handle a CD only around its edges and store it in its protective case (jewel box). A CD and CD player are shown in figure 13-9.

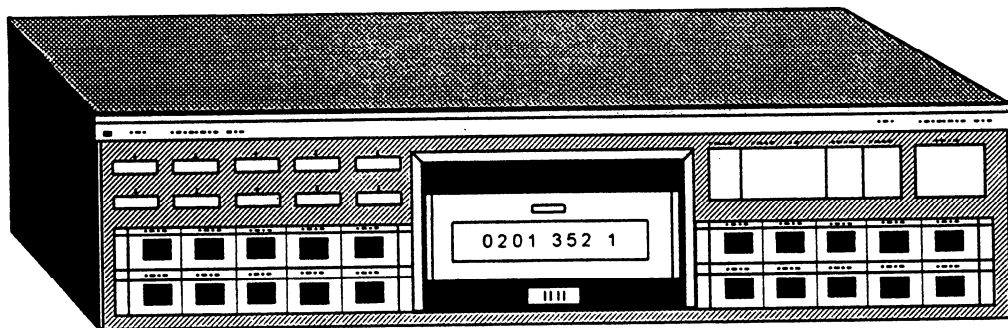
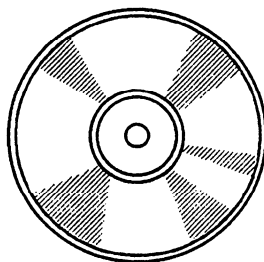

Figure 13-9.—Compact disc (CD) and CD player.

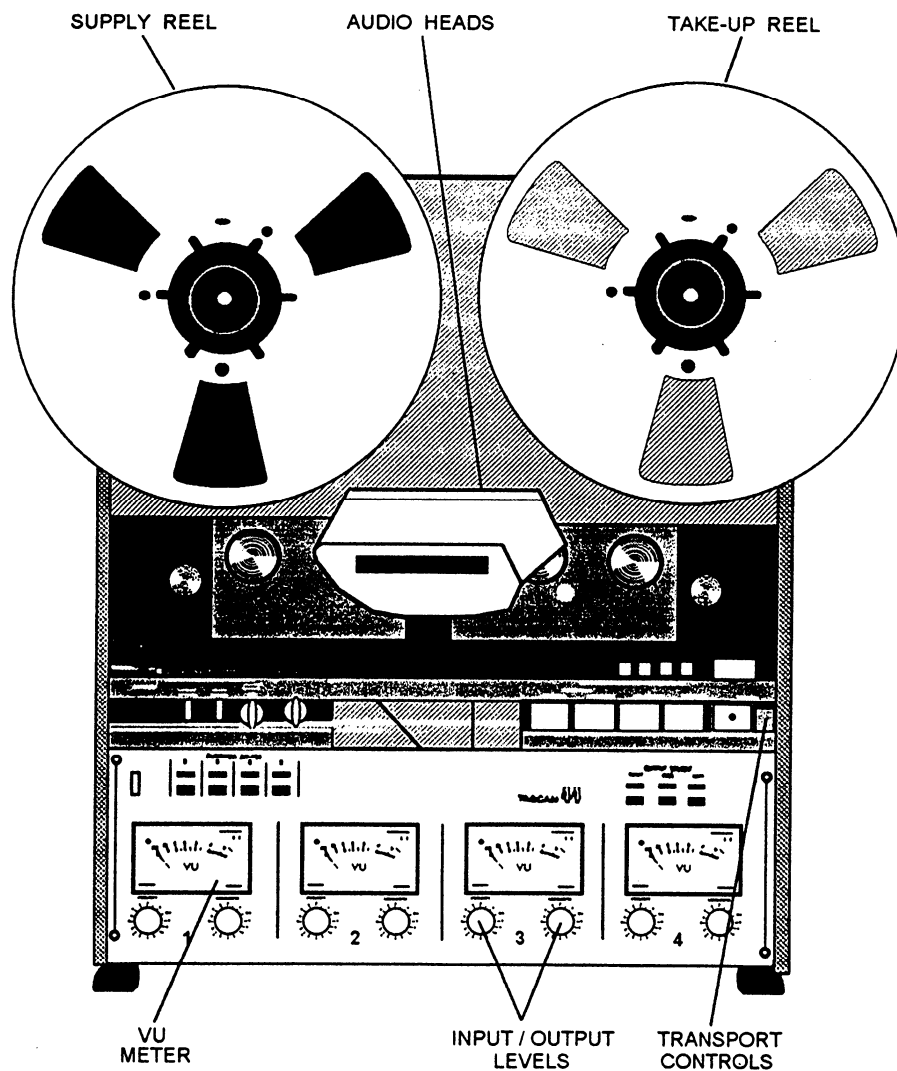

Figure 13-10.—Reel-to-reel tape recorder/reproducer.

## REEL-TO-REEL TAPE RECORD/REPRODUCER

The reel-to-reel tape recorder/reproducer (fig. 13-10) uses magnetic tape supplied on spools. Standard audiotape is one-quarter of an inch wide and it is available in several reel sizes and tape lengths. You must thread the tape onto the machine where it passes the tape heads at either 7.5, 15 or 30 inches per second (ips). Faster tape speeds will give you better recordings.

If you have a sound source on reel tape, load the supply reel onto the left spindle so the tape feeds counterclockwise. Load a take-up reel of the same size on the right spindle. Unwind several feet of tape and thread the machine according to the manufacturer's instructions.

Once you have properly loaded the recorder, you must accomplish the following steps:

1. Set the speed selector of the recorder to the appropriate position.
2. Play the tape and adjust the playback level on the VU meter of the recorder to zero (if the tape has a tone recorded on it). If there is no tone on the tape, adjust the playback level to fall between 80 and 100 percent on the W meter of the recorder.
3. Place the output select of the recorder on the audio console to audition. Using the slider for the recorder, set the sound levels on the audition VU meter to fall between 80 and 100 percent.
4. Once you have set the sound levels, cue the tape to the audio portion to be played. Stop the tape at the

first audio of the selection to be played; then slowly back the tape up to the precise start point of the audio. From this point, back the tape up about half an inch to give the recorder enough space to get up to speed. The tape is now properly cued and the sound levels are set.

**NOTE:** Cuing distances vary from recorder to recorder. Experiment with your machine to get the optimum distance.

5. Place the output select on the audio console into the program mode. The reel-to-reel source is now ready to air.

## MICROPHONES

Setting up your studio microphones before airtime is a relatively simple task. Sit down at the console in the same position you will use when producing or working on air. Place the microphone four to six inches from your mouth at a 45-degree angle. It is possible to set a microphone level by placing the output select in the audition mode and setting the level on the VU meter by using the proper slider. Once you do this, place the output select back into the program mode. Repeat this procedure for the newscaster's microphone.

## RADIO CONTROL ROOM HINTS

Exactly how you get the source "on the air" is simply a matter of choice and experience. Each operator develops his own method of preparing for and actually airing a sound source, and each method has its pros and cons that you should take into account.

The following are some radio control room hints for you to consider.

- Be certain the correct source is aired at the specified time.
- Monitor the VU meter while the source is playing and adjust the volume, if necessary, to maintain the proper VU level.
- If you play two or more sources at the same time, make sure the primary source does not drown out the secondary source(s). You can do this by running the primary source at about 80 percent and the secondary source(s) at about 50 percent initially, adjusting for a final overall output of between 80 and 100 percent.
- If the sound source goes off the air unexpectedly and cannot be restored within a reasonable amount of time (say within five seconds), fill the

time according to your station's emergency procedures.

- **Practice!** To understand your radio control room equipment fully, you will need hands-on experience. The more time you spend practicing studio operations, the sharper your mechanical skills will be.

## EDITING AUDIOTAPE

*LEARNING OBJECTIVE: Identify the method used to edit audiotape.*

One of the advantages of working with reel-to-reel audiotape is that you can edit program material easily. You can remove mistakes and unwanted material from your program to form a cohesive, polished product. The editing process also will allow you to adjust the run time of a program by shortening or lengthening a taped segment. In addition, you may add taped material to another taped program through the editing process.

## EDITING PROCESS

The most common method of editing audiotape is for the unwanted material to be cut out. Although this method has been in place since the introduction of magnetic recording tape many years ago, the "cut and splice" technique is still the preferred editing method of the broadcast industry. The manual reel-to-reel tape edit is simple, requires no expensive or exotic equipment, and depending on the skill of the editor, can produce a clean and extremely accurate edit.

### Finding Edit In/Out Point

You can edit tape manually by taking the following steps:

1. Thread the tape onto the recorder, then place the recorder into the playback mode.

2. To get a better idea of what and how much editing you will need to do, preview the material. This will save considerable time when editing. You can plan your edits by listening to the order of topics or subject items as they occur on the tape. Listen for and note statements that may be in poor taste, against policy or unnecessary. Be aware of items that do not maintain continuity or that are illogical. Consider editing out long pauses that do not add to the program. Time the material to see how you can adjust the program length.

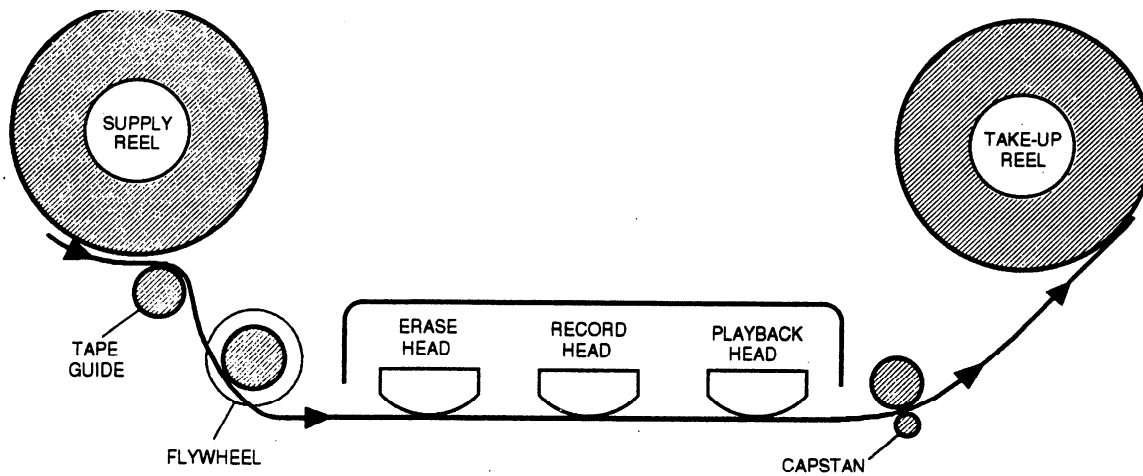

Figure 13-11.—Reel-to-reel tape recorder head sequence.

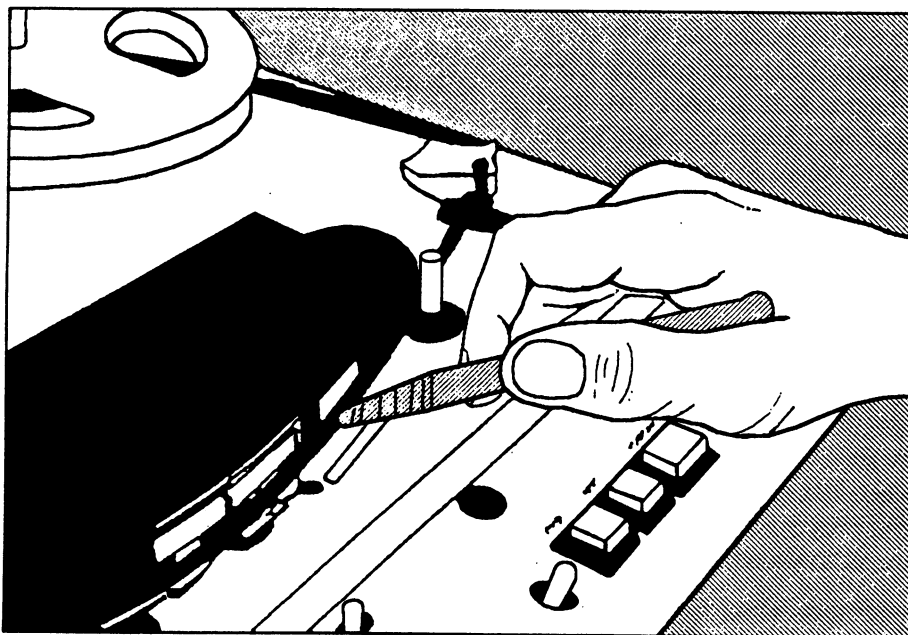

Figure 13-12.—Marking the edit in point on the playback head.

3. Locate the segment of material you want to edit. To do this, you will be concerned with one of three tape heads on the machine. With few exceptions, the tape head sequence (from left to right) is **erase**, **record** and **playback** (fig. 13-11). If there is material that needs editing or if the tape does not meet the timing requirements, listen to the audio and find the point where you want to start your edit. Slowly wind and rewind the tape manually to find the exact **edit in** point. Make a vertical mark on the audiotape at the **edit in** point in the center of the playback head (fig. 13-12). You can do this easily by using a china marker (grease pencil). Make sure you limit your mark to the surface of the tape — stray marks on the tape head could damage it.

4. Find and mark the **edit out** point using the same procedure as for locating and marking the edit in point.

When you mark the edit in and out points, always allow for natural pauses (breathing). If only the bad audio is edited out, there will be an abnormally long pause left on the tape at the point of the splice.

#### Cut and Splice

Once you have located and marked the edit points, you can cut out the desired edited material. To do this, you need a sharp razor blade, an edit block and a roll of audio splicing tape.

If the editing block is not permanently mounted on the base of the recorder, set up the block so that the

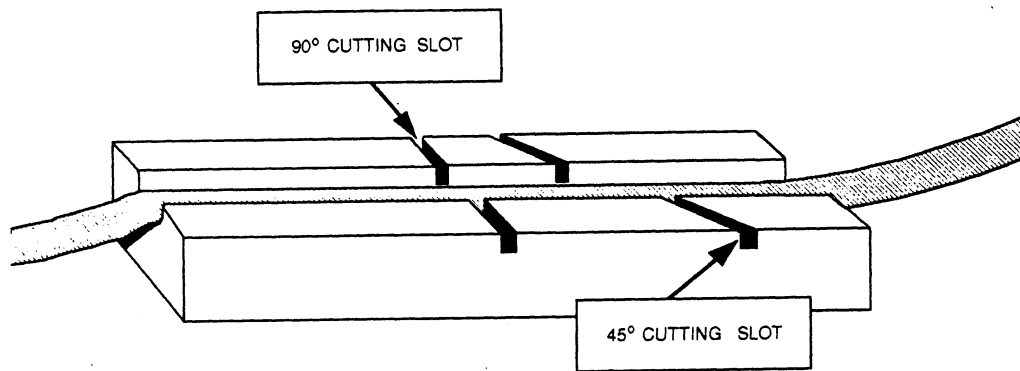

Figure 13-13.—Audiotape editing block.

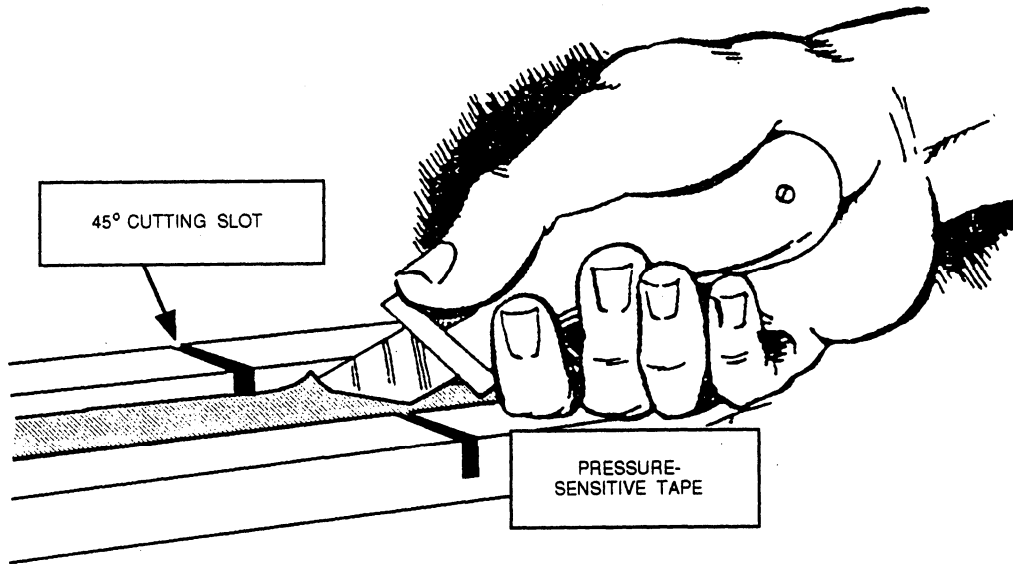

Figure 13-14.—Applying splicing tape.

45-degree cutting slot is to the right of the 90-degree slot, as shown in figure 13-13.

Cut and splice the tape using the following procedure:

1. Rewind the tape to the **edit in** point. Make sure you unwind enough tape to be placed into the editing block. Press the tape, oxide (dull) side down, into the edit block so it is held in place by the grooved slots of the block

2. Center the marked **edit in** point over the 45-degree cutting slot in the edit block, as shown in figure 13-13.

**NOTE:** The 45-degree slot is most frequently used, because it is a stronger bonding edit than one made from a 90-degree vertical cut. The 45-degree angle cut also reduces the chance of an audible popping sound at the edit point during playback.

3. Cut the tape carefully with a razor blade, using the diagonal slot as a guide. Remove the tape on the left side of the cut.

4. Place the recorder into the edit mode and push STOP once you find the **edit out** point. Unwind enough tape to locate the **edit out** point and center it over the 45-degree cutting slot. Cut the tape carefully at the edit mark with a razor blade.

5. Once you make the final cut, remove the loose tape from the left side of the cut and set it aside until you check the edit and run time of the program. You may need to splice in this section later.

6. Push the remaining tape ends together in the edit block so there is no gap or overlap. Join the two ends using a piece of 7/32-inch splicing tape about one inch in length (fig. 13-14). Press the splicing tape firmly over the cut.

**NOTE:** Always use tape manufactured for audio-tape splicing. Any other types of tape may damage the tape heads.

## **Review the Edit**

After you complete the edit, review it to make sure it meets the requirements of your station. Use the following procedure:

1. Review the edit by first removing the audiotape from the splicing block and examining it for defects. If a defect is present, remove the splicing tape and repeat the edit.

2. Rethread the tape onto the recorder and play the edited segment. Listen for popping or clicking sounds. Also, pay attention to the continuity and aesthetics of the program. Make sure conversations flow smoothly and the content of the message is not changed or destroyed. Be alert for policy violations and adherence to time requirements. If you note any problem areas, repeat the editing process as needed.

3. Once you are satisfied with the finished product, label it according to the procedures of your detachment and give the tape to your supervisor.

## **RADIO PROGRAM MATERIALS**

*LEARNING OBJECTIVE: Identify the radio program materials available from AFRTS.*

This section briefly describes the various radio program materials available from AFRTS-BC. It is important for you to know the contents and abbreviations for each package, since you will rely on them for most of your day-to-day radio programming needs. If you need more detailed information, see the *Armed Forces Radio and Television Service (AFRTS) Program Materials*, DoD Directive 5120.20-R, Appendix F.

AFRTS-BC ships 80 hours of radio program materials to their AM outlets per week. More than half of the weekly package consists of current music programs featuring major-market DJs. The music heard on these programs is the same as played on many popular music FM stations across the United States. Another portion of the weekly package consists of recordings of the latest hits according to various music charts. To provide the widest possible variety of radio programming, AFRTS-BC includes religious, talk, drama, variety and other program formats in the weekly package.

FM stations also are furnished with program packages. The stations receive a basic FM package along with taped stereo music shipments consisting of vocals and instrumentals.

## **RADIO UNIT PACKAGE (RU)**

The radio unit package (RU) contains approximately one-half (30 hours) of the total radio programming package and is generally undated. It is routed through circuits of one or two outlets. In the RU package you will find weekly religious shows, dramas, features, variety shows and information “fillers.” Under normal circuiting (routing), one unit is available for broadcast and two other RUs are either at the station or enroute.

## **RADIO PRIORITY/LIBRARY PACKAGE (RP/L)**

Teaming with the RU package to provide full AFRTS radio entertainment is the radio priority/library package (RP/L). This weekly package has two parts — the radio priority package (RP) and the radio library package (RL).

### **Radio Priority Package (RP)**

The RP package contains approximately 45 hours of timely (dated) materials, including chart music programs, and is shipped to each authorized radio station for immediate broadcast. Because the RPs contain timely material, they have no value after they are aired and include instructions for immediate local destruction. RPs are authorized only for stations that receive the RU package.

### **Radio Library Package (RL)**

The RL package contains approximately six hours of individual recorded music cuts on CD for retention as permanent library material. Because RL material is designed for permanent library retention, shipments continue during temporary periods when other programming may be suspended. A computer floppy disk, containing artist and title information, is included in each shipment. The CDs in the RL package are accountable items and periodic inventories are mandatory.



## **40-C**

Stations authorized to receive the RP/L package also receive the American Top 40 and the American Country Countdown programs as a separate RP shipment labeled 40-C. Like the RP unit, materials in 40-C are destroyed after airing.

### **RADIO TAPE PACKAGE (RT)**

The radio tape package (RT) is a weekly audiotape shipment consisting of approximately 84 hours of RU, RP, 40-C and special information items for authorized ships and selected shore-based stations. Packages contain 14 7-inch tapes recorded at 3 3/4 ips in a fro-track monaural format that can be run on simple automation or manual playback systems. At the end of each recorded track, a 25-hertz tone cues tape reversal and automatic switching to the next track, enabling small radio operations with the proper equipment to automate a full broadcast day. RT units are returned to the duplication contractor after airing so the tapes and shipping containers can be recycled. Outlets authorized to receive the RT package will not receive the RU, RL or 40-C shipments.

### **RADIO MATERIALS (RM)**

Occasionally, your station may receive the radio materials (RM) shipment. It may contain entertainment or information programs, holiday specials, special features, spots or production aids. The type and timeliness of the material will determine whether the RM is shipped on CD or tape and which outlets will receive it.

### **FM TAPE SERVICES**

The three packages available under the heading of FM tape services are FM library (FML), FM program (FMP) and FM religious (FMR). These tapes provide alternate programming for authorized outlets with second broadcast frequencies or cable distribution channels. Tapes are recorded in four-track stereo at 3 3/4 ips on 10 1/2-inch reels. Cue tones are prerecorded on the tapes for automation equipment.

#### **FML**

The FML unit is a monthly shipment of roughly 24 hours of library music in three formats — beautiful music, adult contemporary and country. It is designed for permanent retention by the station.

#### **FMP**

The FMP unit is a quarterly shipment consisting of about 26 hours of hosted stereo programs.

#### **FMR**

The FMR unit is a religious music program service that includes 12 55-minute hosted programs in each shipment.

### **HANDLING INCOMING SHIPMENTS**

When a shipment of radio program materials arrives at your station, make sure you take the following actions:

- Inspect the exterior of the packages. Make sure the boxes are not torn, ripped, crushed or otherwise damaged.
- Double-check the address to make sure your station is entitled to receive the shipment.
- Carefully open the boxes or containers.
- Locate the packing list and inventory the contents of the packages against the packing list.
- Check each tape or CD label. Make sure that they match the packing list.
- Inspect each item for damage. Look for scratches and defects.
- Note all shortcomings on the packing list.
- Sort tapes and CDs according to the types of units (RP, RU, etc.).
- File the tapes and CDs according to local guidance.

### **GENERAL HANDLING GUIDELINES**

All tapes and CDs must be handled with care. Careless practices, such as leaving CDs on a table without protecting them, result in scratches or chips. A tape left in the production studio unmarked and out of the box is an invitation for someone to erase it. Therefore, tapes and CDs must be cared for according to standard industry techniques and practices.

Cleanliness is paramount. Areas where tapes and CDs are used and stored should be free of dust, high

humidity and excessive heat. Keep your hands clean and avoid touching the surfaces of tapes and CDs with your fingers.

Store tapes in their original boxes. The boxes should be clearly labeled and stored in the appropriate location. You should store tapes vertically to keep the reels from bending and to prevent packing them tightly. The ends

of the tapes should be secured to the reels with masking tape before storing them. Do not use transparent adhesive tape because the adhesive can damage recording tape.

Handle CDs so the surfaces are not exposed to fingerprints, dirt, and so forth. As mentioned earlier, you should always store CDs in their protective jewel boxes.

## CHAPTER 14

# TELEVISION

Television is the offspring of three media — the theater, film and radio. In a relatively short period (about 45 years), television has progressed from a mere novelty, to arguably, the most powerful information and entertainment medium.

The technological advancements of television in this short time frame are quite remarkable. Color television sets virtually replaced black-and-white models, cable television eliminated the need for viewers to tune in broadcast channels with “rabbit ear” antennas, and videotape, videotape machines and character generators (CGs) signaled the end of 16mm television film and cumbersome production equipment and methods.

The military services recognized the potential of this new form of communication and started Armed Forces Television at Limestone Air Force Base, Maine, in 1953. The success of this experimental station convinced DoD officials that overseas television stations were feasible. One year later, the DoD officially recognized the television mission and combined it with Armed Forces Radio to form the Armed Forces Radio and Television Service (AFRTS). In 1976, the CNO established the Navy Broadcasting Service (NBS) to manage AFRTS outlets within the DON.

Most likely, your initial television broadcasting experience will be with an NBS detachment overseas or aboard a ship equipped with a Shipboard Information, Training and Entertainment (SITE) system. For these reasons, you are responsible for knowing the basics of this fascinating but demanding medium.

### HOW TELEVISION WORKS

*LEARNING OBJECTIVE: Identify how the television medium works.*

Television is the process of converting reflected light rays from a subject or scene into electrical impulses and reproducing these impulses at a distant receiver.

The television camera picks up reflections of light from the scene, while the microphone picks up sound. The camera changes the light reflections into electrical impulses, and at the same time, the microphone changes the sound into electrical impulses. These impulses are sent to the transmitter or are recorded on videotape.

To be viewed, the signal from the transmitter is received by the viewer’s television set, or the recording is played back — either to the transmitter or directly to a receiver. At the receiver, the picture and sound signals are isolated and sent through separate picture and sound circuits. Electronic components within your television set change these signals back to video on the cathode-ray picture tube and audio on the television speaker.

### THE TELEVISION CAMERA

*LEARNING OBJECTIVE: Recognize the basic operation, electronic characteristics and main types of television cameras.*

The television camera is the heart of the television system. It records the varying amounts of light reflected from objects in the televised scene. This amount of light varies according to the lighting, color or shade of the object.

Figure 14-1 shows a banner with the word *NAVY* printed in black on a white background. The border

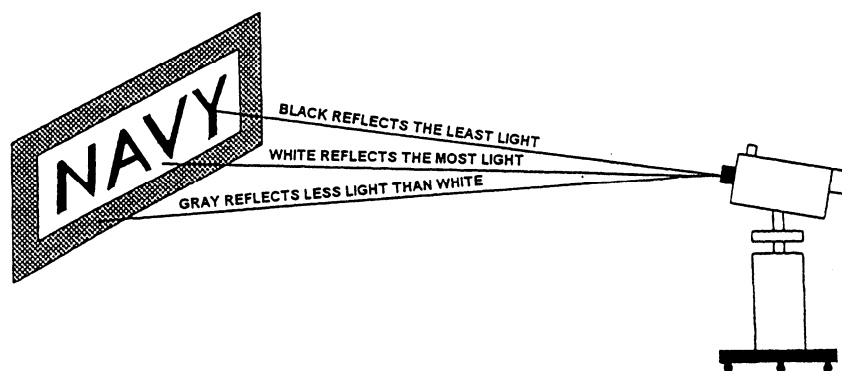

Figure 14-1.—The various amounts of light seen by the television camera.

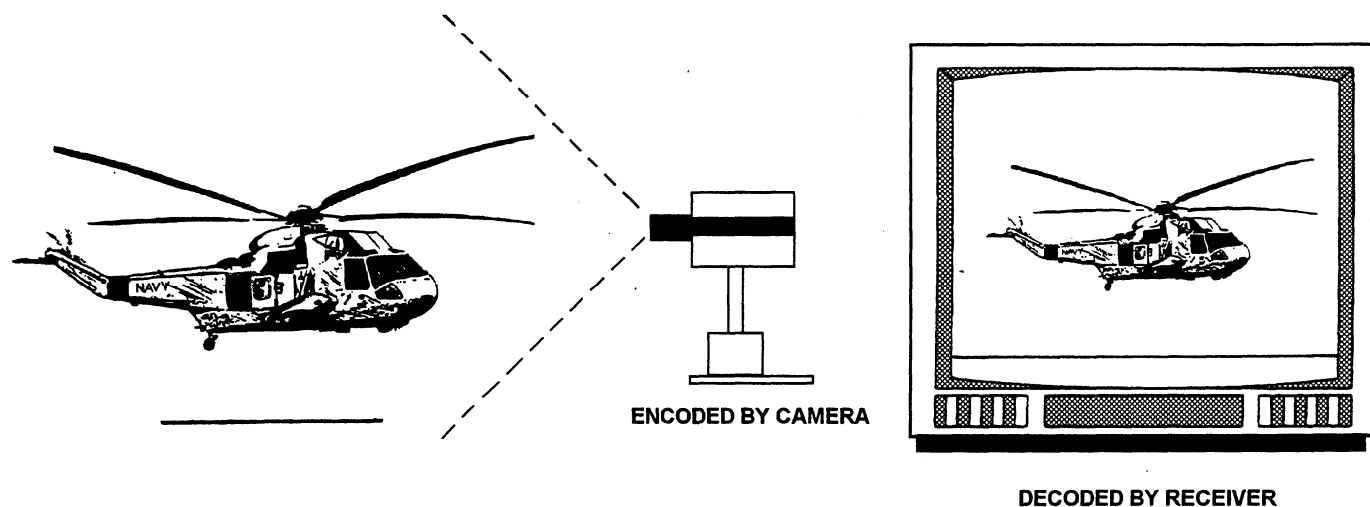

Figure 14-2.—The scanning process.

around the banner is gray. When light hits the banner, it reflects from the three different shades in different amounts. The white background reflects the most light, the gray reflects less, and the word *NAVY* reflects very little light. From this you can see that a scene made up of different shades or colors reflects different amounts of light. The television camera takes these various levels of light reflection and changes them into electrical impulses of varying strength.

A television camera is optically similar to a movie camera, except it does not use film. Instead, light reflections from the scene are focused by a lens and pass through the face of the photoelectric transducer (also called a pickup tube) of the camera. The pickup tube does the job of film in a camera. Its surface is coated with thousands of tiny globules of silver mixed with other chemical elements. This coating is photosensitive, which means it gives off electrons when exposed to light. Light from the scene covers the entire surface of the pickup tube and electrons are forced off its rear surface. The number of electrons forced off any part of the pickup tube is determined by the amount of light that strikes this part.

In figure 14-1, the Navy banner causes the pickup tube to give off electrons corresponding to the amount of light reflected from various parts of the banner.

At the present time, there is no practical method for transmitting a complete video picture instantaneously as a whole unit. Therefore, in television, the picture is broken into tiny units called elements, which are transmitted individually in sequence. The elements are so small that the human eye cannot distinguish one from

the other in the complete picture. The process of registering all the elements of a video picture in sequence is called scanning. During the scanning process, the television camera “encodes” the elements; then the television receiver is used to “decode” them in the proper order to recreate the original image (fig. 14-2).

## ELECTRONIC CHARACTERISTICS

In this section, we examine the following electronic characteristics of a television camera:

- Operating light level
- Video noise

### Operating Light Level

You need a certain amount of light in order for the pickup tube of the camera to perform its function. Although there are several ways to measure light, the footcandle is one of the more common units of measurement.

Whatever term is used, make sure your light-measuring device is in the same language as the manual for your camera. For example, if the manual calls for a minimum of 100 footcandles of light, you will need a light meter that reads in footcandles.

Some cameras have a way to give you more light when you need it. The dB gain switch (fig. 14-3), usually located on the back of the camera, has two positions — 6dB and 12dB. For every 6dB of gain, the camera output

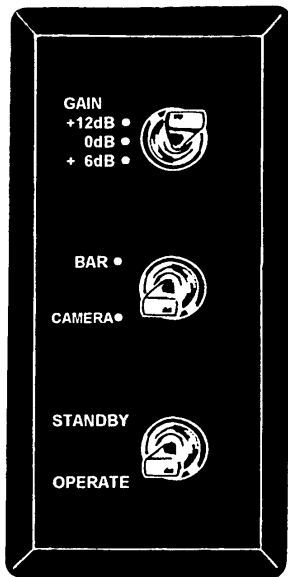

**Figure 14-3.—Television camera dB gain switch.**

signal doubles in amplitude to increase the video level effectively. That means the 6dB setting doubles signal strength and the 12dB setting is four times more than the 6dB gain.

## Video Noise

Video noise increases in proportion to the video gain previously described. Even the best cameras will deliver “noisy” pictures under low-light levels. A noisy picture has a great amount of snow, or white vibrating spots, in the picture. This occurs when the video signals produced by the pickup tube are not strong enough to override the electronic interference the system usually generates. At 12dB gain, the system is generating more electronic interference — and more video noise.

Having covered the basic operation and electronic characteristics of a video camera, we now examine the types of video cameras you will work with at NBS detachments.

## STUDIO CAMERA

The studio camera (fig. 14-4) is the backbone of the television industry. It is mounted on a dolly pedestal so the camera operator may wheel it to different locations with relative ease during shot changes.

Television technicians monitor and adjust the video levels of the studio camera with the camera control unit

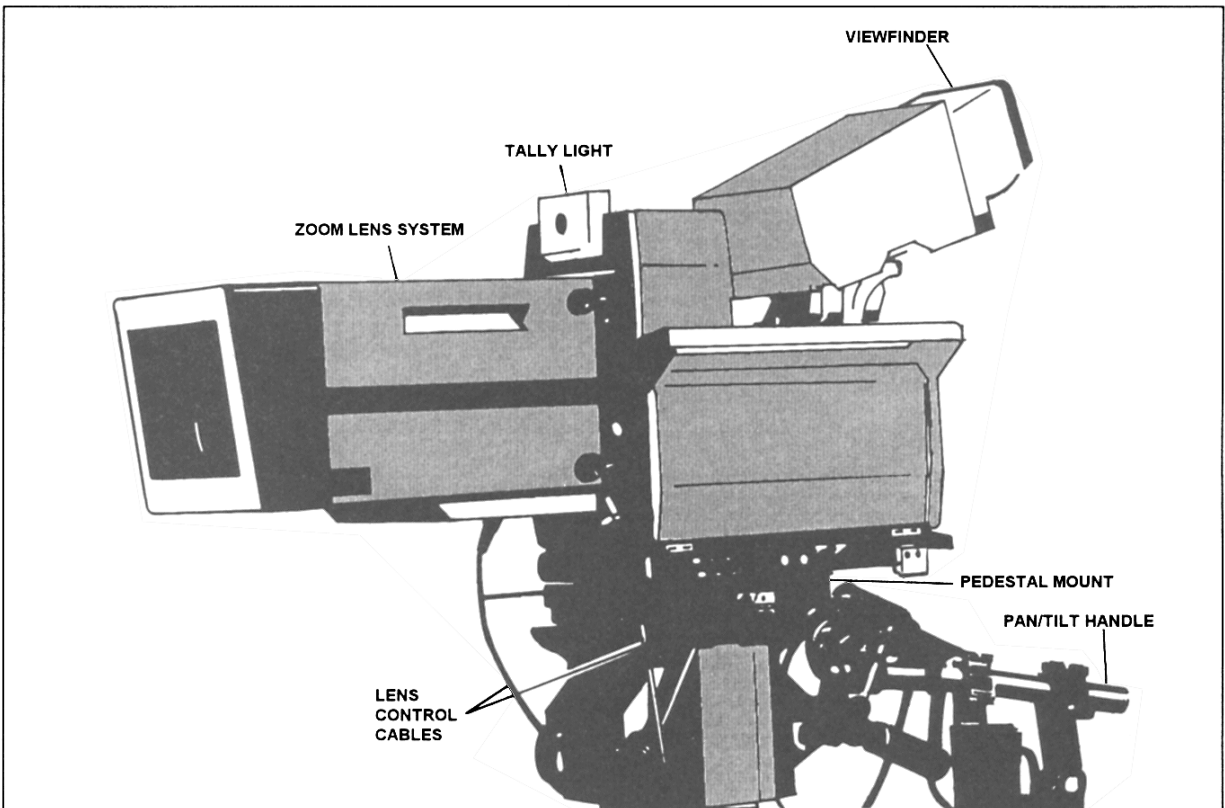

**Figure 14-4.—Studio camera.**

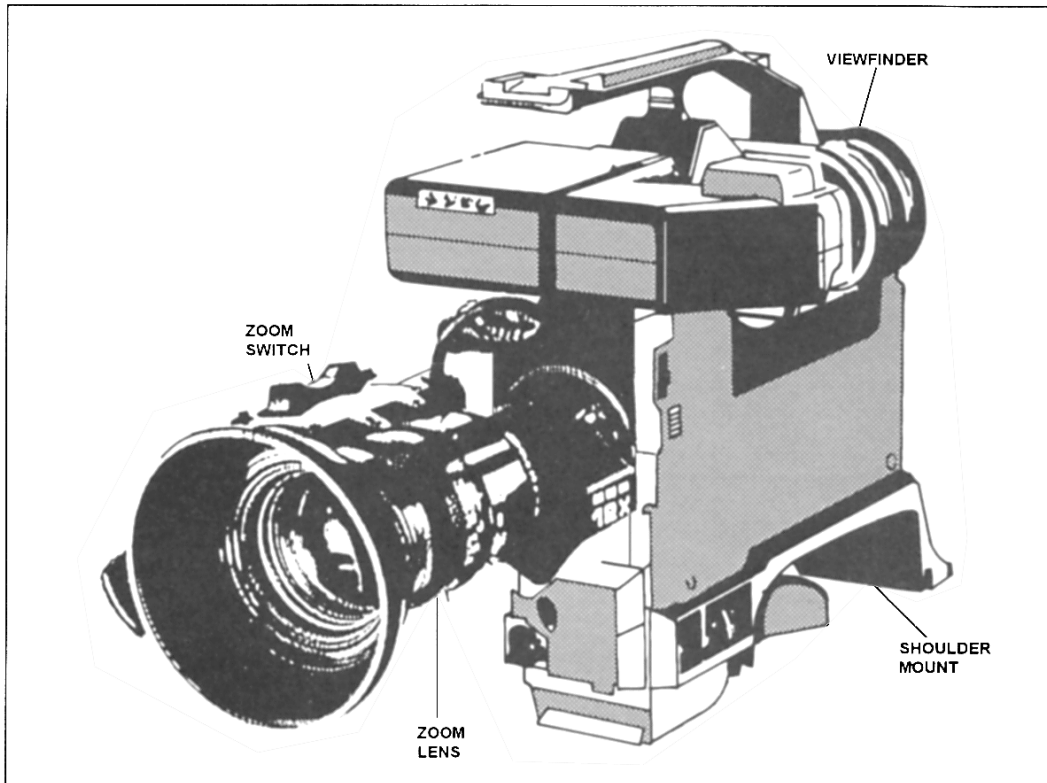

**Figure 14-5.—Electronic news gathering (ENG) camera.**

(CCU), usually located in the control room. The CCU consists of a waveform monitor (an oscilloscope that displays a video signal graphically), television monitor and shading control.

Studio cameras are expensive, ranging in price from under \$5,000 to more than \$100,000. However, the more expensive cameras deliver high-quality images in a variety of production conditions.

### **ENG CAMERA**

The electronic news gathering (ENG) video camera replaced 16mm motion-picture film for television news in the mid-1970s. The ENG cameras are automated and fully operational within a few seconds after they are switched on. You can make adjustments to extreme production situations quickly and easily.

Most ENG cameras weigh between six and 20 pounds, depending on the number of pickup tubes inside the camera. They are powered by batteries, but you may also run them from AC current using an adapter. An ENG camera is shown in figure 14-5.

### **CONVERTIBLE CAMERA**

Some of the more expensive ENG cameras maybe converted from an ENG format to a studio camera head with a large viewfinder and advanced zoom lens. In terms of practicality, the convertible camera is tough to beat because you can use the same camera for two distinct applications. For instance, you can use a convertible camera to cover the 11 a.m. ribbon-cutting ceremony at the new Navy Commissary, then connect it to a CCU in the control room for the evening news six hours later. Furthermore, the convertible camera is invaluable for remote productions requiring several cameras, such as sporting and entertainment events. A convertible camera is shown in figure 14-6.

### **CAMCORDER**

Unlike the standard ENG camera, which must be connected to the videocassette recorder (VCR) with a cable, the camcorder (fig. 14-7) combines a camera and a videocassette in one unit. The camcorder weighs less than an ENG camera and may be operated by one person. This allows increased mobility in tight ENG situations.

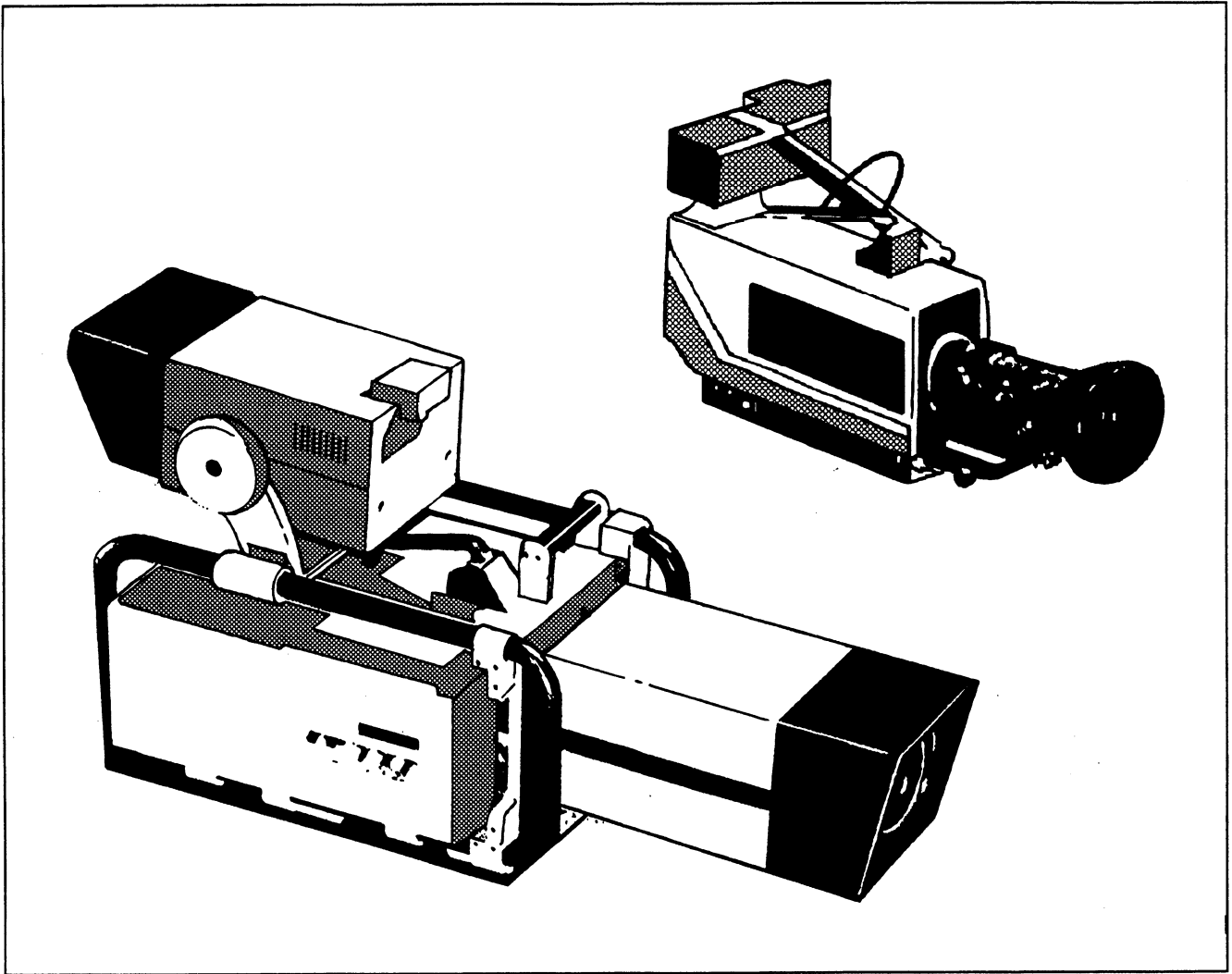

Figure 14-6.—Convertible camera.

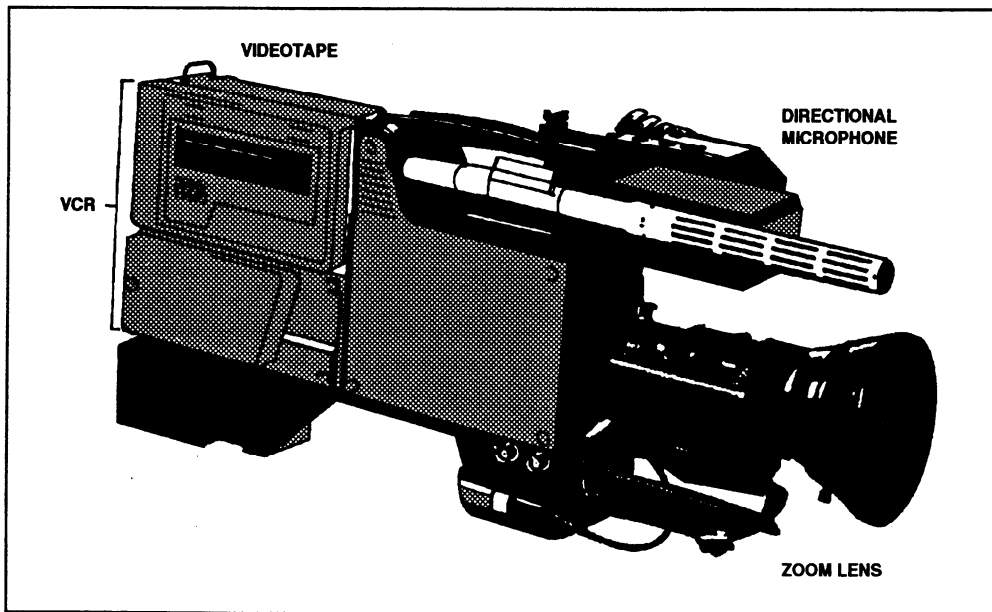

Figure 14-7.—Camcorder.

## TELEVISION CAMERA OPTICS

*LEARNING OBJECTIVE: Identify the optics of a television camera.*

You were introduced to the functions of camera lenses in Chapter 11. The lenses and the associated optics for television cameras (save viewfinder) operate in the same manner as still photography, but we will cover them briefly as they apply to the television medium.

### VIEWFINDER

The viewfinder on an ENG camera is a relatively small television screen (1.5 inches in diameter), while a studio camera viewfinder is larger (3 to 9 inches in diameter). They both produce high resolution black-and-white images. The television screen on an ENG camera is shielded from outside reflections by a flexible rubber eyepiece that adjusts to the operator's eye. In that rubber eyepiece, there is an adjustable lens for you to focus since the eye is placed within an inch or two of the screen. The studio viewfinder uses a hood to shade the television screen from overhead studio lights.

Within the ENG camera viewfinder, there are a number of control lights or displays that indicate the status of certain camera functions. Most viewfinders automatically display information on tape status, battery condition, tally/record light and low-light level indicator. The viewfinders display, on command, color bars, patterns, white/black balance setup cursor and camera registration. All camera viewfinders are black-and-white.

In some camera models you may use the viewfinder as a playback monitor for the VCR. The advantage of this feature is that you do not need additional equipment to set up the camera. However, some video camera manufacturers are discontinuing this feature because today's cameras are more reliable and recorders have indicators to let you know when you are recording.

### LENS

The lens selects a certain field of view and produces a small, clear optical image of this view. The lens and certain attachments are sometimes called the external optical system.

When you work with video camera lenses, you concern yourself with the following four areas:

- Focal length
- Focus
- f/stop

- Depth of field

### Focal Length

As you learned in Chapter 11, focal length is the distance from the optical center of the lens (which is not always its physical center) to the point where the image, as seen by the lens, is in focus.

Portable television cameras have a zoom, or variable focal-length lens (fig. 14-8), that allows you to select fields of view at different distances from the camera without moving the camera. It allows you to change the focal length of the lens from long to short or from short to long in one continuous operation. A complicated series of lenses interact to keep the object in focus at all times during the zooming process. "Zooming in" is the gradual changing of the lens from a wide-angle lens to a narrow-angle lens. On the television screen, a zoom in appears as though the camera is moving smoothly toward the object. "Zooming out" is the changing of the lens from a close-up to a distant shot and it will appear that the camera is moving away.

The degree to which you can change the focal length of a zoom lens is the zoom range of your lens. The range is often given in a ratio, such as a 10:1 zoom range. This means you can increase your focal length 10 times. Some cameras have a "times two function," which allows you to double the focal length at any point in the zoom, thus making the maximum 20:1 for the above example.

You can control the speed of your zoom either manually or by using a zoom servo. These features are covered in the following text.

**MANUAL ZOOM CONTROL.**— The manual zoom control on ENG cameras is a small rod extending from the zoom ring. To zoom in or out, turn the zoom rod clockwise or counterclockwise. It takes some skill and practice to accomplish smooth zooms with the manual control.

**ZOOM SERVO.**— A zoom servo is nothing more than a small motor controlled by a lever. The distance the lever is depressed determines the speed of the zoom — typically from 2.5 to 20 seconds. The lever is called the zoom selection or T/W switch — T stands for telephoto and W for wide angle.

There are several advantages to the zoom servo system. Zooms are steady and smooth, especially during slow zooms. The zoom control is easy to operate and allows you to concentrate more on picture composition and focusing. The zoom servo also frees the left hand to operate the manual focus and aperture controls.



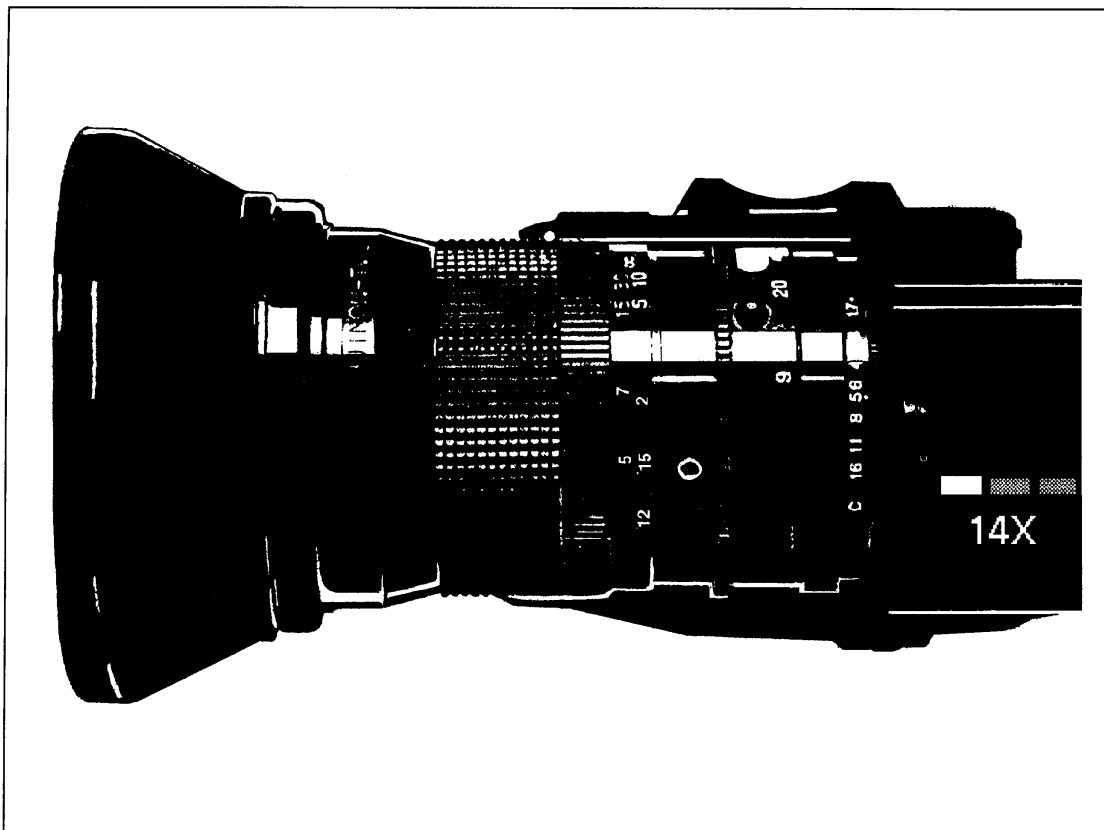

Figure 14-8.—Zoom lens.

You must be aware of two disadvantages of the zoom servo. Although relatively quiet, some zoom servo motors emit a humming noise that is picked up by the camera-mounted microphone. Additionally, the motor uses power provided by the camera battery.

**FOCUS CONTROL.**— The focus control is usually a rubber-covered ring on the zoom lens. To operate it, you rotate the focus ring either clockwise or counterclockwise while looking in the viewfinder to determine if the picture is in focus.

### Focus

Two methods of setting the focus on a zoom lens are used. One, called **zoom focus**, is done by zooming all the way in and setting the focus, then zooming out to the desired focal length. Once this is done, everything in the depth of field will remain in focus, including the object focused on, provided the distance between it and the camera does not change.

Another focusing method is called **rack focus**. This is nothing more than your setting the focus on something in the field of view. When you do this, only that object and other objects at the same distance will remain in

focus as long as the distance between them and the camera does not change.

You should rack focus when there is not enough time to zoom focus. However, there are times when the effects of a rack focus are desirable, such as when the viewer's attention is directed toward something in the foreground and you want to lead him to another object. You can do this by changing the focus to bring the other object into sharp focus while the first object goes out of focus.

### f/Stop

As noted earlier, the camera pickup tube will operate properly only within a certain range of light intensity. If too much or too little light falls on the pickup tube, the picture quality will suffer.

Since you will use the camera both indoors and outdoors, you must compensate for extreme differences in light levels. The lens diaphragm, or iris, is used to control the amount of light that enters the lens and the camera by enlarging or reducing the aperture. The f/stops indicate the size of the lens (diaphragm) opening.

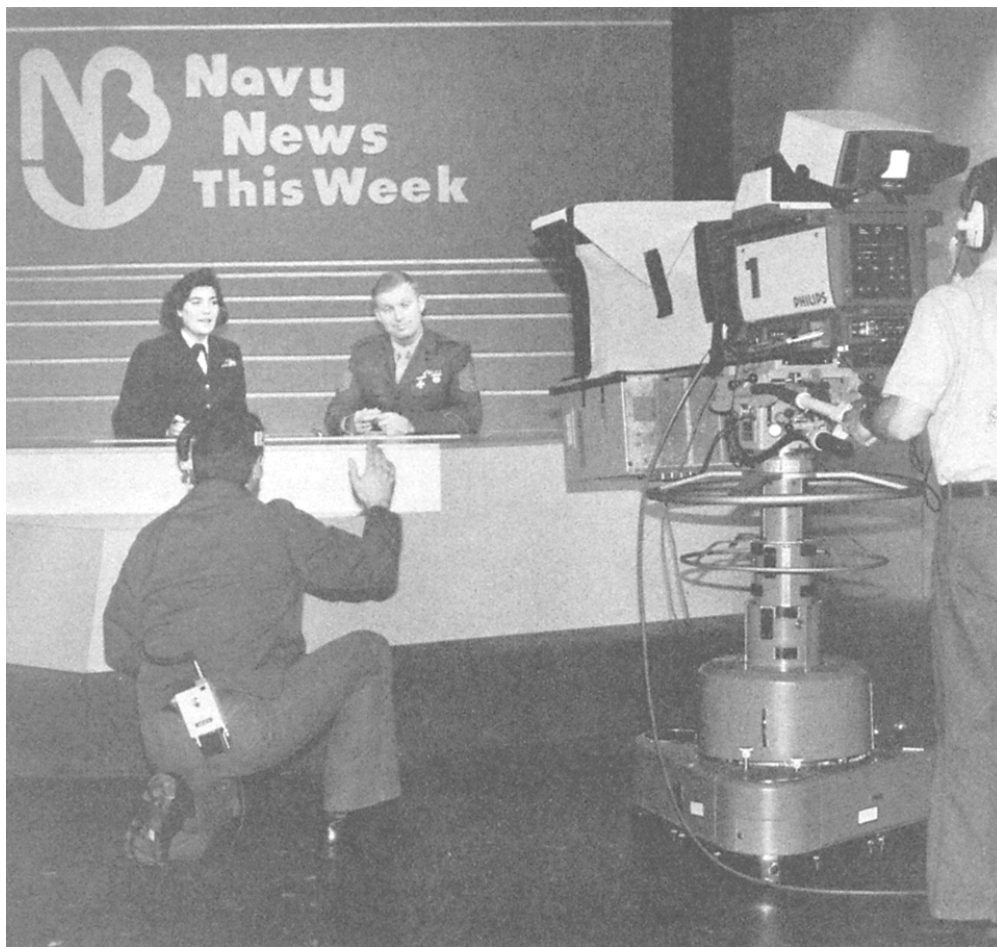

**Figure 14-9.**—The talent, camera operator and floor manager on the set of Navy News This Week (now titled Navy/Marine Corps News).

The lower the *f*/stop number, the wider the lens opening. When you zoom in, the lens will require more light, a wider opening and a lower *f*/stop number.

Most television cameras have an automatic iris that allows you to devote your attention to other important aspects of videography, such as framing and composition. Although the automatic iris seems ideal for ENG assignments, it does not always work to your advantage. With fairly even illumination, the auto iris closes down when it sees an extremely bright area in a scene or opens up when it senses a large, dark area. You can avoid this by switching to the manual iris control.

### **Depth of Field**

It is important for you to know that *f*/stops do more than just determine the amount of light entering the camera. They also affect the depth of field.

As in still photography, a large diaphragm opening (small *f*/stop number) decreases the depth of field, and a small diaphragm opening (large *f*/stop number) increases it. The same rules apply when you move the camera. A great depth of field makes it easy for you to keep the subject in focus while moving short distances, whereas a shallow depth of field makes it impossible for you to move without getting the subject out of focus.

### **THE TELEVISION STUDIO PRODUCTION TEAM**

*LEARNING OBJECTIVE: Recognize the members of a television studio production team.*

A television production, such as the one shown in figure 14-9, relies on the expertise of several individuals who do a myriad of jobs. These jobs are interdependent and must be coordinated to perfection.

As a member of a television studio production team, you will be called upon to function in any one of the following positions:

- Talent
- Camera operator
- Floor manager
- Audio switcher
- Video switcher

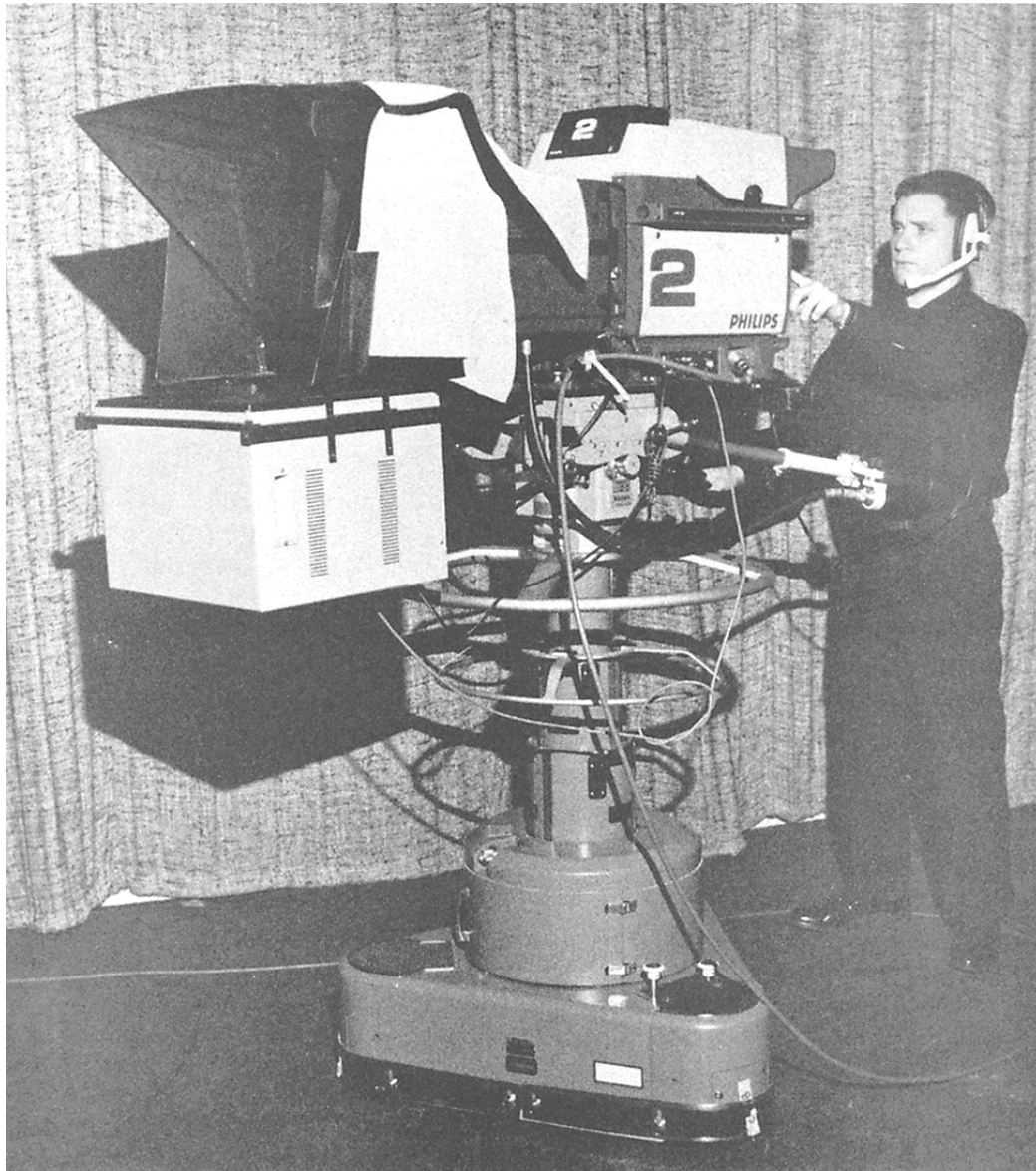

**Figure 14-10.—Camera operator with headset.**

- Director

## **TALENT**

The television studio production centers around a performer of some sort, whether it be the CO explaining a change in base policy on captain's call or a colleague delivering the evening news. In television parlance, the performer is known as the talent. An array of support people assists the talent, including those who handle copy, wardrobe and makeup. The talent receives instructions from the director through the floor manager.

## **CAMERA OPERATOR**

The images that appear on the television set are first determined by how and what the camera sees. Images from several cameras may be available for the director

and video switcher to use or blend to produce the transmitted picture. Unlike recorded videotape, the editing of a live studio production is accomplished as the picture is transmitted. Thus the television camera is the most important single television production element. All other elements and techniques are geared to the physical and electronic characteristics of the camera. Lighting, scenery, audio, writing and directing all depend, more or less, on the potential of the camera.

In most television studio productions, there are several cameras operating at the same time. As a camera operator, it is your responsibility to make sure you can operate your camera efficiently. You can only be efficient when you are completely familiar with your camera and use practical television camera-operating techniques.

During a production, you wear a headset that gives you direct communication with the director (fig. 14-10).

The director tells you when your shot is about to be used and when it is being used live. Even when your shot is not live, you should attempt to keep a shot that the director may find useful to the program. This will allow him to use that shot for coverage if something goes wrong with another shot or camera.

You may receive instructions from the director to move the camera, either to a new angle or to a new position on the studio floor. It is essential to a successful television production that all camera movements be carried out correctly, quickly, quietly and smoothly. The director relies heavily on the conduct of the television camera operators, and his job is easier when you respond to his commands not only quickly but accurately. This is particularly important during unscripted programs. (Television shooting techniques, including specific camera movements, are covered later in this chapter.)

## FLOOR MANAGER

The floor manager stays in the television studio during a production. Through a headset system, he is in direct, two-way communication with the director in the control room. Normally, the talent is not able to use a headset and cannot receive instructions directly from the director. It is the prime responsibility of the floor manager to act as a liaison between the talent and the director.

Since it is not practical for him to instruct the talent orally during a production, the floor manager stands or kneels next to the camera that the talent should speak to and uses a system of hand signals to relay the director's instructions. Although any hand signal system understood by both the floor manager and the talent will work, we recommend you use the universally accepted system shown in figure 14-11.

The basic hand signals that both the floor manager and talent must understand are listed in the following text.

- **Stand by.** For the hand signal to “stand by,” the floor manager raises his hand and arm at the beginning of the show or following a spot break
- **Cue.** For the hand signal to “start talking” or “begin action,” the floor manager raises his hand and points to the talent.
- **Cut.** For the hand signal to “cease talking” or “stop action,” the floor manager draws his hand across his throat in a slashing motion.
- **Stretch.** For the hand signal to “stretch it” or “slow down,” the floor manager pulls his hands apart as if stretching a rubber band. Longer amounts of time are indicated when the floor manager places his hands farther apart at the end of the stretching motion; shorter time amounts are indicated when the floor manager places his hands closer together.
- **Speed up.** For the hand signal to “talk faster,” the floor manager rotates his arm and hand clockwise in a circle above his head. The speed of the rotations are related to the urgency of time.
- **OK.** For the hand signal that “everything is fine,” the floor manager makes a circle with his thumb and forefinger.
- **30 seconds to go.** For the hand signal that there are 30 seconds remaining in the show/segment, the floor manager forms the letter *T* with both hands.
- **15 seconds to go/wrap it up.** For the hand signal that there are 15 seconds remaining in the show/segment and the talent should wrap up what he is doing, the floor manager creates a grabbing motion with his hand that results in a fist.
- **Speak more softly.** For the hand signal to “speak more softly,” the floor manager raises the palm of his hand to his mouth.
- **Speak up.** For the hand signal to “speak up,” the floor manager cups his ear with his hand.
- **Speak or look at this camera.** For the hand signal to “speak or look at this camera,” the floor manager points to the on-air camera with his hand. A waving motion from one camera to another alerts the talent that the director is switching the shot to another on-air camera.

Be precise and deliberate when you deliver hand signals. Do not wave your arms in the air frantically — this will only confuse and imitate the talent.

During a television production, the studio floor is usually a maze of lighting and camera cables that can hinder the movement of the cameras and also be a safety hazard. The floor manager must make sure these cables are stored or positioned safely. Furthermore, he should find out from the camera operator and director how much camera movement is expected.

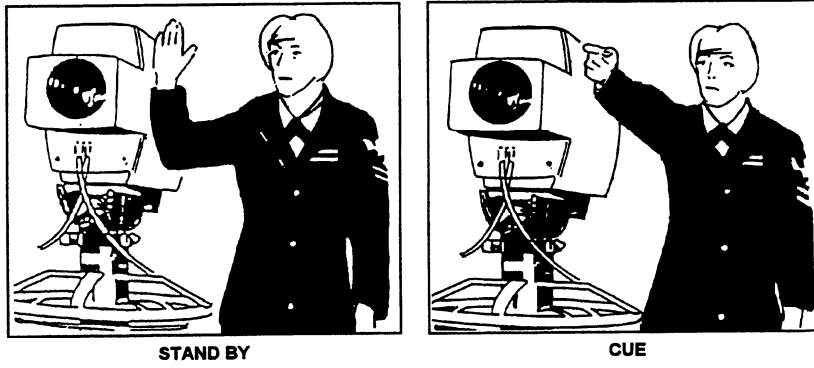

STAND BY

CUE

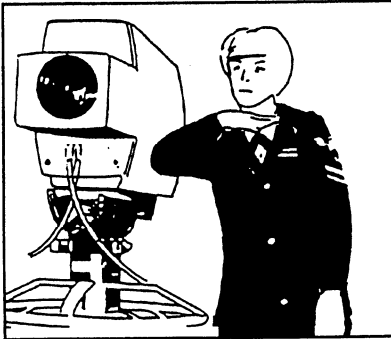

CUT

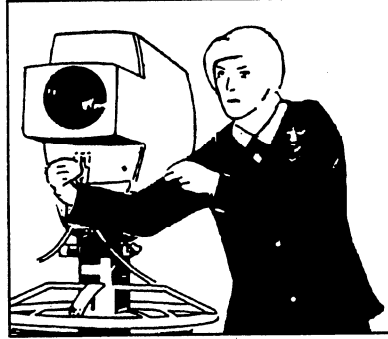

STRETCH

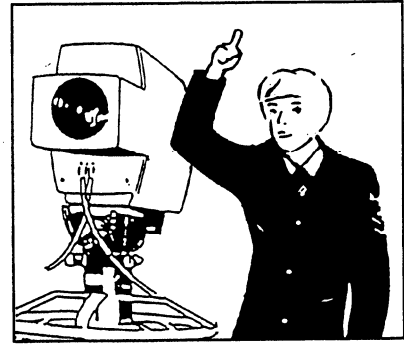

SPEED UP

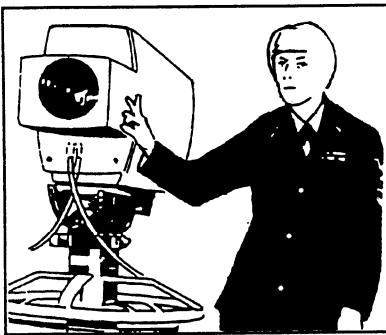

OK

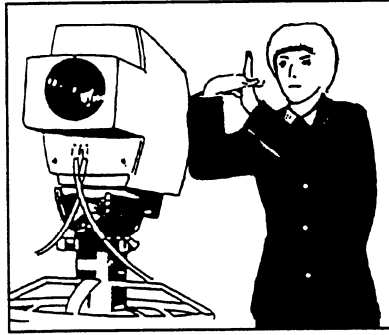

THIRTY SECONDS TO GO

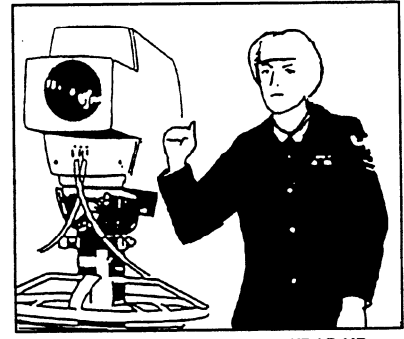

FIFTEEN SECONDS TO GO/WRAP UP

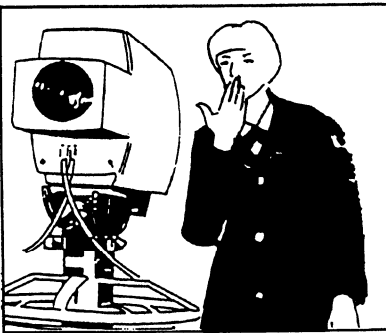

SPEAK MORE SOFTLY

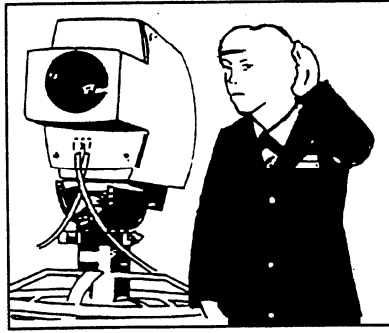

SPEAK UP

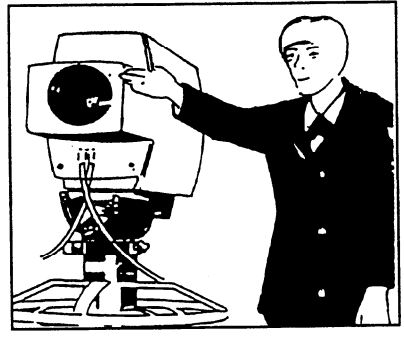

SPEAK OR LOOK TOWARDS THIS CAMERA

Figure 14-11.—Floor manager's hand signals.

Once a production is under way, any number of problems may develop on the studio floor. Cameras may refuse to move or the talent may develop giggling fits. In normal circumstances, the only way the director can find out about these problems is through the floor manager. Therefore, another responsibility of the floor manager is to keep the director informed of any developing situations on the studio floor that may affect the program.

## **AUDIO SWITCHER**

The audio switcher is responsible for the smooth operation of the television audio mixing console. He must be able to respond quickly and correctly to the commands of the director.

The television audio mixing console is usually located in a separate booth, remote from the television control room. The audio switcher stays in the booth from the time immediately before the production — when he makes the necessary sound level checks — to that of the completion of the program. The console itself has all the sound inputs fed into it, including microphones from the studio floor, cart machines, CD players, and so forth. The audio switcher has absolute control over these inputs and must balance them so that they are at a compatible level.

Once all of the inputs are balanced, they maybe fed from the console to a receiver. The output must be at a level that is acceptable to the receiver (videotape recorder, television set or monitor) and must fade-in or fade-out at the command of the director. With practice, you will be able to mix and control sound smoothly and correctly.

## **VIDEO SWITCHER**

Although the camera operator frames the shot and the director calls for it, the video switcher (fig. 14-12) is ultimately accountable for the picture that is recorded or broadcast. The video switcher is responsible for the smooth operation of the video-mixing console and the special effects bank He directly controls what the audience sees. A mistake on his part cannot be covered up by the director.

The video switcher sits at the video-mixing console throughout the production and is completely responsible for its smooth operation. He must be able to operate the console efficiently and respond quickly and correctly to the commands of the director. The video switcher can only achieve such efficiency by having a thorough knowledge of the console equipment and by constantly

practicing mixing techniques. In addition, the video switcher must know how to apply the various special effects available to him and operate them smoothly.

## **DIRECTOR**

The television studio production crew is a team, with everyone in the team working together toward one common goal — the successful airing of a production. Although each member of the team is responsible for the correct and efficient operation of his particular task, there has to be someone in charge — someone with an overall view of the situation and the way the various tasks are accomplished. This person is the director.

The director is totally responsible for the production He is able to give instructions to every member of the crew, either directly, or in the case of the talent, indirectly. These instructions must be clear and concise — garbled instructions are worse than no instructions at all.

In a scripted production, only the talent *needs* a script, but it is the director's responsibility to be completely familiar with it so he may devote more of his attention to the actual production and less time wondering what the talent is going to do next.

It is also the director's responsibility to be aware of the functions of each member of his crew and their equipment. There is probably nothing worse and more frustrating for a production crew than to work with a director who sets impossible tasks for his crew because he is unaware of the functions and limitations of his people and their equipment.

During a studio production, the director gives commands to the camera operators and the audio and video switchers. These commands are covered in the following text.

### **Camera Commands**

The director issues commands to the camera operators more than any other production team member to accomplish the following tasks:

- Setup shots
- Refine the framing and composition of a shot
- Direct the movement of a camera while the shot is on the air

When you serve as a director, you should remember the following guidelines:



**Figure 14-12.—Video switcher.**

1. **Give a “ready” or “standby” cue whenever possible.** Your doing so tells the camera operator to hold a particular shot and that airing is eminent. Additionally, it is a good practice that you give a “ready” command just before a camera movement. For instance, if the talent is seated and is scheduled to getup and move to the left, you would say, “Camera 3, ready to pan right with the talent.”

2. **Identify each camera by number.** You will know each camera operator by name, but you should issue camera commands using the appropriate camera number.

3. **Begin a command with the camera number.** Do not say, “Ready to pan right with the talent, Camera 3.”

4. **Be specific when issuing commands.** For example, the command “Camera 1, zoom out” is too

vague for production work. Instead, you should say: “Camera 1, zoom out for a bust shot.”

### **Switcher Commands**

The director should follow the same basic guidelines for camera commands when issuing commands to the video and audio switchers. In some situations, the director will give switcher commands while actually performing the switching functions himself. This is done primarily to alert team members of video and audio transitions.

Try to economize your words when you issue switcher commands. For instance, instead of saying, “Ready to cut to Camera 2 . . . Cut to Camera 2,” say “Ready to take 2 ... take 2.” Your using fewer words takes less time and cuts down on the possibility of confusing team members.

In addition you should give commands to the video switcher *last*. This is because the video switcher is normally positioned close to the director and needs less time to respond to a command than camera operators or the floor manager. Give your commands in this order:

1. Audio switcher
2. Talent
3. Video switcher

## TELEVISION VISUALS

*LEARNING OBJECTIVE: Recognize the technical requirements and main types of television visuals.*

As a television broadcaster, you must be able to think visually in order to make the most of the television medium. In some cases, visuals can tell the entire story by themselves and should be an integral part of a production instead of an afterthought. You may have heard the cliché, “One picture is worth a thousand words.” This is true because effective visuals will help you tell the story with more clarity. A viewer’s imagination can actually provide the “soundtrack,” sometimes enhanced by narration (used sparingly) and television dialogue.

The term visuals maybe broken into the following three subgroups:

- Graphics (maps, charts, diagrams, illustrations, printed IDs, outlines and summaries and CG information)
- Photographic techniques (still photographs)
- Television backdrops, props, scenery and subject/talent visual information not included in the first two categories

## TECHNICAL REQUIREMENTS

Before you plan or use any type of television visual, you must be aware of the technical limitations and guidelines involved. Even if you do not actually design or prepare the visuals, you must be able to guide your artist and understand the limitations of visuals.

It is important for you to understand how visuals must be tailored for television before producing or selecting them. For example, a novice television broadcaster may see a random visual he likes and try to use it immediately, while a seasoned veteran will base his decision on more scientific guidelines and will not rely on first impressions.

Any producer of television programs learns quickly that he needs a “working knowledge” of many contributory fields. One of these is graphic arts. All television shows use graphic materials — title cards, photographs, illustrations, charts and maps — just to name a few. Graphic materials greatly enhance news and feature productions, spot announcements and virtually all types of television programs. Keep in mind that, in television it is important for you to present information visually as often as possible since people remember visual information longer than the spoken word. Without visuals, you lose the force of this powerful medium.

Whether written, pictorial, diagrammatic or sheer design, visuals have a place in almost every television production. In preparing visuals for television, you should pay close attention to the aspect ratio, scanning area, essential area, border area and the size of the visuals.

## Aspect Ratio

The aspect ratio of any television screen, regardless of its physical size, is 3:4. This means the television screen is divided into three units high and four units wide. The visual elements should be kept in a format size that will complement either 6:8 or 9:12. These aspect ratios will help you keep the materials and objects within the 3:4 aspect ratio format shown in figure 14-13. A television visual prepared within this aspect ratio will be seen in its entirety on the television screen. Conversely, think about what would happen if you were to shoot a vertical photograph without the proper aspect ratio. The photograph would lose a major portion of its

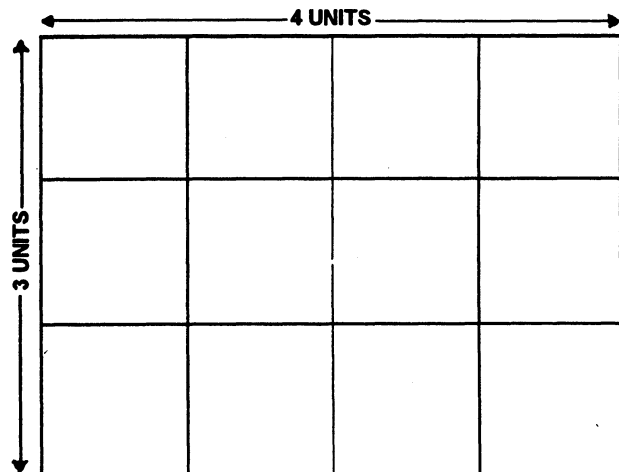

Figure 14-13.—Television aspect ratio.



information from either the top or bottom, or its sides, and visually, it would look poor on the television screen.

### Scanning Area

The total area seen by the camera is called the scanning area. This image is transmitted fully, but the outer edges and the corners usually do not appear on the home television set because of the shape of the picture tube. A properly aligned television receiver will display all scanned information at the top and bottom center of the picture, but will crop corners because of the nonsquare corners of the picture tube.

The common mistake many new television broadcasters make is allowing too much headroom at the top of the picture. Remember: the home receiver sees everything at the top center, so do not overcompensate the same way you do for edge and corner cropping.

### Essential Area

The portion of the picture that reaches the viewer must include all of the important information — this is known as the essential area. All visuals have a scanning area and an essential area. The scanning area is the entire picture from top to bottom and from side to side. The essential area is the meat of the picture — the main information within that picture area. Both the scanning and essential areas of a picture are shown in figure 14-14.

### Border Area

The border area is another important area of the television picture. Graphic artwork should have a border around the scanning area for the following reasons:

1. It helps prevent the picture from being damaged if dropped.

2. It helps protect the artwork from fingerprints and smudges.

3. It may prevent your audience from seeing past the card to some behind-the-scenes activity if the camera operator did not have time to frame the shot properly.

4. It serves as a “bleed-off” area for overscanned sets. The excess border contains no essential information.

### Size

There is no specific size of studio title cards or other television visuals. However, a generally accepted size is 11 by 14 inches. It is best that all visuals be made the same size for storage purposes. The 11- by 14-inch size fits well in a standard file cabinet. The cards should be numbered with a piece of marking tape on the edge. Stagger these tabs for easy access.

A visual that is 11 by 14 inches offers the following advantages:

1. It allows an ample 2-inch handling border so fingerprints and smudges will not damage the primary information.

2. It leaves a 9- by 12-inch working area for both the camera operator and artist.

3. It is compatible with the aspect ratio requirement of 3:4, thus incorporating a measure of safety.

It is also wise for you to mark off an additional 10 or 15 percent inside this 9- by 12-inch area. Your doing this will give you a copy area of about 7 1/2 by 10 inches and compensates for the picture area lost because of cropping (transmission loss) on the home television receiver (fig. 14-15).

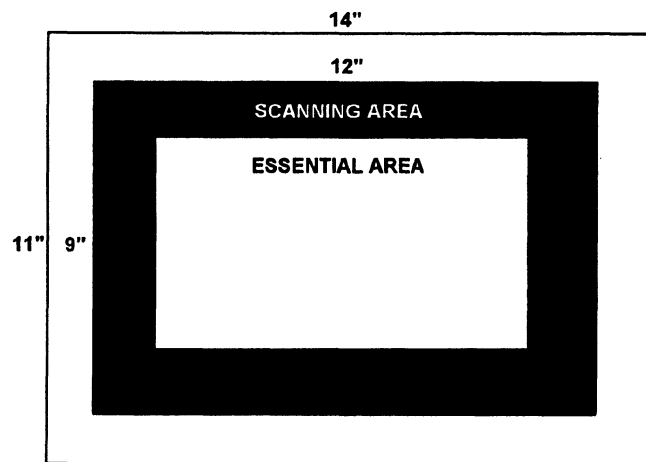

Figure 14-14.—Scanning and essential areas of a television picture

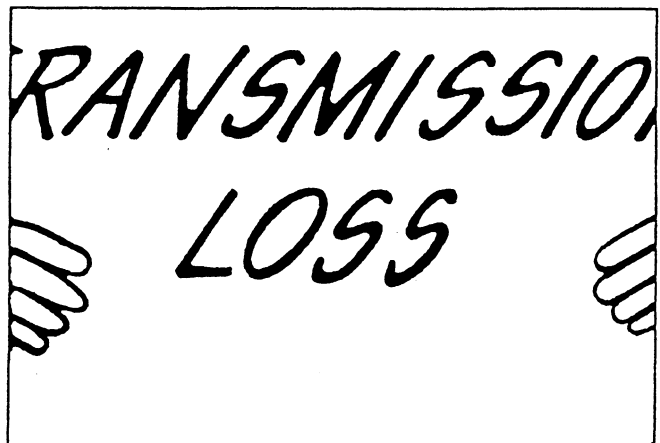

Figure 14-15.—Transmission loss.

Remember to use the scanning area! The total scanning area is visible on most television sets, but there is a 10-percent loss on others. Therefore, keep all pertinent information within the essential or “safe” area. This is especially critical when you use words.

## **TYPES OF VISUALS**

The types and uses of visuals are limited only by your imagination. Visuals come in various forms, each having a name that makes it easily identifiable to production and artwork staff members.

The following is a list of the major types of television visuals:

- studio card
- Plain title card
- Combination title card
- Super/key card
- Chroma key card
- Maps and charts
- Character generator
- Computer graphics

### **Studio Card**

The studio card may be a mounted photograph or an illustration. It sits on an easel and maybe a plain card (words only) or an illustration or picture with words. Combining words and illustrations requires the coordination of two video sources, such as a character generator and art.

### **Plain Title Card**

The plain title card has printed lettering (without any pictorial background), such as the title of the show, the name of the performers and producer, and so forth. Rich, deep color backgrounds with light lettering make reading easy.

### **Combination Title Card**

The combination title card has lettering against pictorial information for the background. The picture

may be either artwork or photography. The lettering may be either on the card itself or on an overlay.

### **Super/Key Card**

During the showing of a super/key card, the card lettering is superimposed electronically over another background (or over another picture) from either another camera or from a film chain camera. This technique is an accepted form for placing the name of the subject on the air while the subject is talking. Use only simple, bold letters and try to restrict the amount of information on the super/key card. Normally you should avoid white lettering on a black background, because the contrast between the two is too great. Nonetheless, in this case, the lettering must be white and the background black.

Use caution when you plan the super/key card. You must consider how two camera shots will look as one picture. In addition, you should place lettering in the lower third of the card and center the card on the picture. This is done so you will not obstruct the background or the main action.

### **Chroma Key Card**

The chroma key card is similar to the super card, except the background for the lettering is usually blue instead of black and the letters are i-reprinted on the card. The background of the card may be any color. However, most television producers use a chroma-blue background color, because it makes skin tones appear natural and suppresses picture distortion.

Through electronic means, the chroma-blue background becomes transparent during the matting process, only showing the typically white or yellow letters. The camera picture from the second camera shows through without interfering with the foreground image. The chroma key matting process appears to the viewer as a rear screen projection, such as when the picture is keyed (shown) behind an announcer or is a boxed support graphic inserted alongside the announcer. The video source may be a VCR or a live television camera shooting a studio card.

### **Maps and Charts**

Maps and charts are also important visual aids for television programs, especially newscasts.

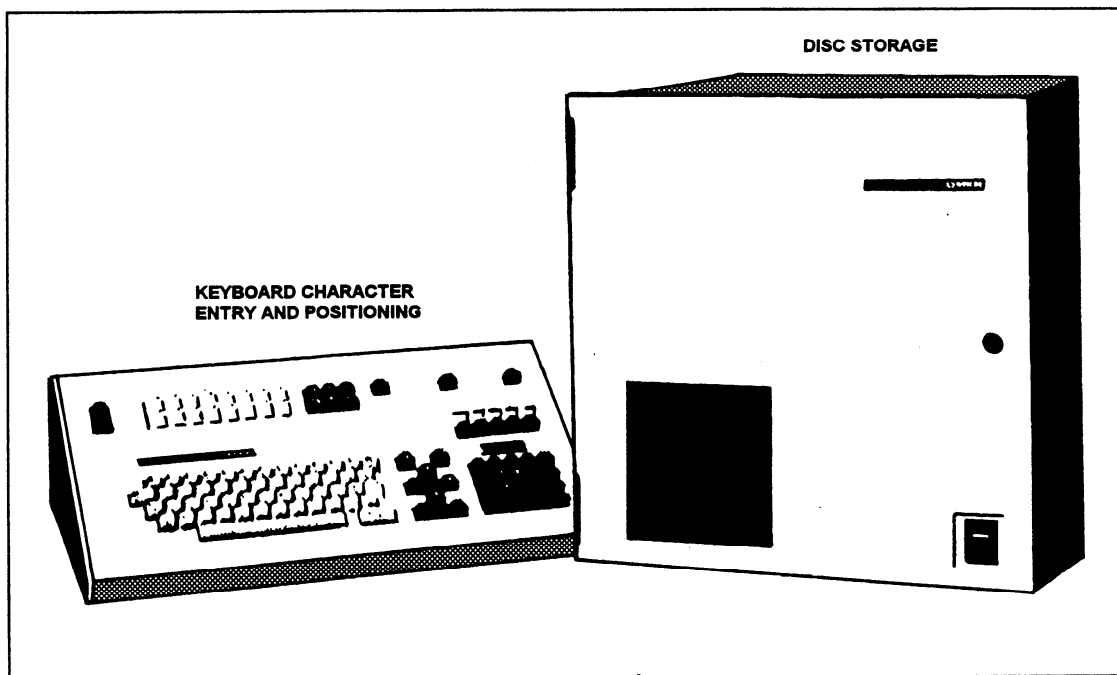

Figure 14-16.—Character generator (CG).

You can limit details to the essential areas by using simplified drawings. For example, if you want to emphasize the state of Colorado on a map of the United States, you could retrace the borders and darken the state area with green or blue tints.

Keep written copy on charts to a minimum. Maximum clarity with minimum essentials must be your chief objective.

### Character Generator

When you have a lot of printed information to air, such as sports scores or closing credits, you should use a character generator (CG) (fig. 14-16). The CG is a computer graphics system used widely in closed circuit and broadcast television. It creates letters and numbers in a variety of sizes and fonts and requires no special skill for the user to make flawless letters.

A CG has a solid-state keyboard similar in appearance to a microcomputer keyboard, except it contains additional keys for specific CG functions. As you create text, you may store it in RAM (random access memory) and recall it as needed. Since RAM is cleared when microcomputers are turned off, most CGs use a floppy or hard disk drive system for permanent text storage.

Some of the more advanced CGs feature 14 to 16 lines of 32 characters within the frill-screen scanning area line-by-line memory recall, automatic centering, word flash, word or line underline, stand alone titling, titling over video and two-speed roll (or crawl) through all or part of the memory. You may even program the letters in certain color arrangements by using a colorizer. A cursor helps you move information to any location on the screen.

Although the CG is a timely means to display information, you should not rule out the use of other graphic support material.

### Computer Graphics

Computer graphics, the newest elements of the television medium, have all but replaced 35mm slides for television work. This process starts with an electronic picture recorded on videotape. The computer operator converts the picture into a digital code format and stores it either on the hard disk drive or a floppy drive. When the image is needed, a graphic artist retrieves it and converts it into an electronic picture. Now he may paint or draw a picture using an electronic pen and palette. The graphic artist can add or delete information and change the colors of the picture and letters at will while “on-the-air.” Some advanced computer graphic systems have a wide range of colors and can produce detailed animation.

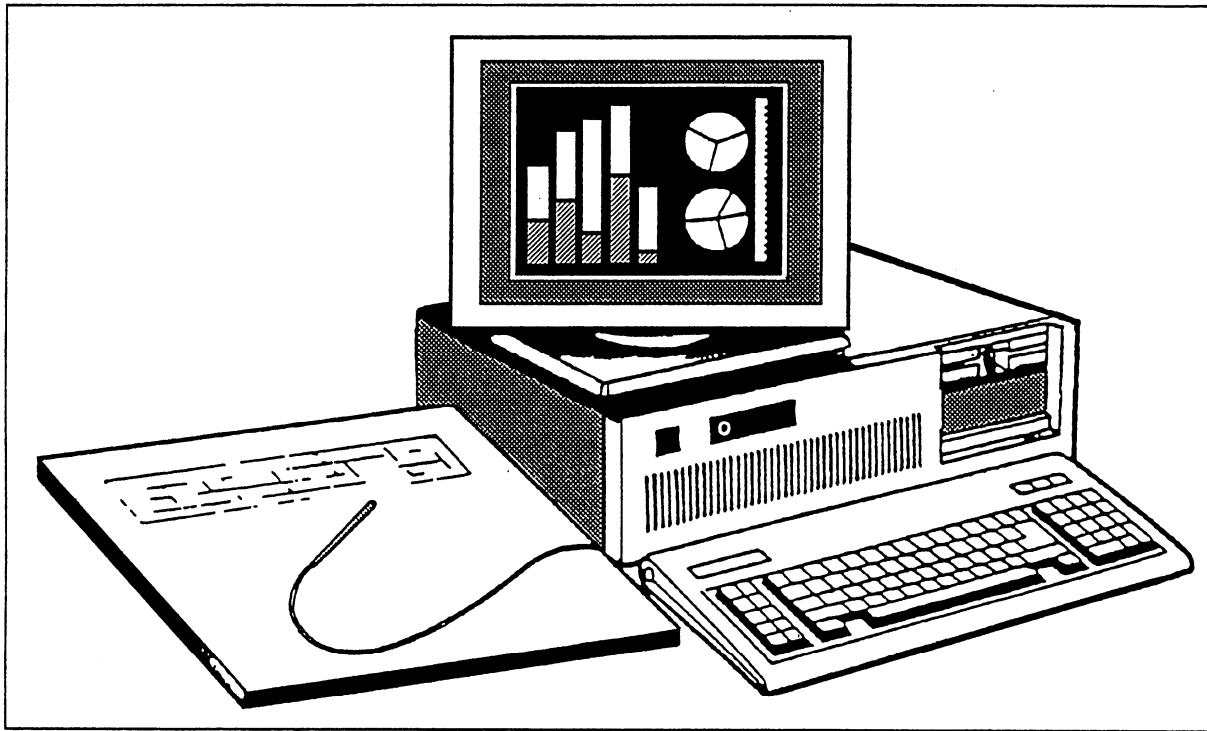

Figure 14-17.—Computer graphic system.

A computer graphic system is shown in figure 14-17.

### PREPARING TELEVISION VISUALS

*LEARNING OBJECTIVE: Identify the techniques used to prepare television visuals.*

Regardless of the purpose or format of your television visual, you must consider the following basic aesthetic elements:

- Simplicity
- Contrast
- Balance and composition
- Lettering

#### SIMPLICITY

The old adage, “Keep It Short and Simple” (KISS), certainly applies when you create television visuals. Your visual should be uncomplicated and easily recognized. Do not make the viewer work too hard to understand what he is seeing. For example, viewers normally will ignore a visual with too much lettering. Additionally, try to keep colors to a minimum.

All copy or lettering must be readable. Fancy fonts may look good on paper, but they might not permit the viewer to understand what you are trying to convey.

Sizing of the subject in the picture also is important. “Keep the primary subject somewhat large within the picture that you are framing. Do not make the viewer strain to read or see the subject. A good subject size is about one-half inch in height on a 19-inch monitor.

#### CONTRAST

High definition, or contrast quality, is important for reproduction over a television system. Contrast in visuals should be sharp but not excessive. Avoid large areas of white. The pickup tube(s) of the camera will transmit glitter and flair when you shoot high-intensity reflected light, especially during camera movement. This also may introduce audio noise into the television picture.

The human eye can identify about 100 different shades of gray. The television camera clearly identifies only about 10 shades. Since the brightest area can be no more than 20 times as bright as the darkest area, you must be careful when using pictures and visuals that have high contrast.

You also should consider how color will appear on a black-and-white (monochrome) television set. Color material will appear as shades of gray on a monochrome

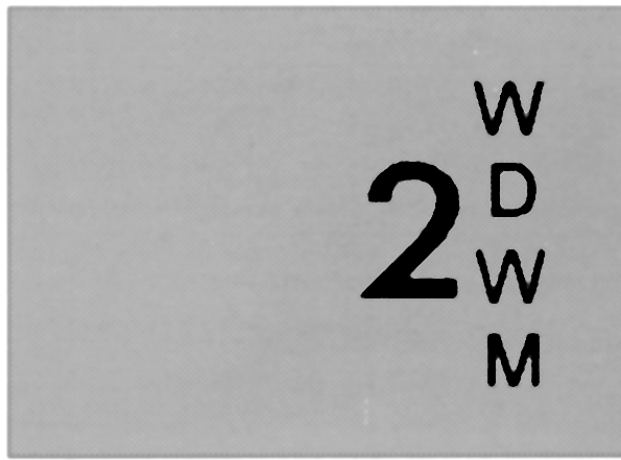

**UNBALANCED**



**BALANCED**

**Figure 14-18.—Unbalanced (left) and balanced station identification visual.**

television set and must be used according to its gray scale value. The best way to test colors is to check them with a color television camera and monitor. You will find that brown, purple, dark blue and black appear black on a monochrome television; red, medium blue and medium green appear dark gray; light blue, chartreuse, gold and orange appear light gray; and pastels, bright yellow, light gray and tan appear almost white.

Even a color television system acts as a filter — it only sees a portion of the hue (color) and saturation (color strength) that the human eye can see. Most color cameras have trouble with the colors red and orange. Saturated colors cause excessive video noise or color stretching over the entire screen. Stripes or color banding also may show up as color vibrations, thus disrupting the picture. Stay with basic, solid colors — primarily blues and greens — and avoid supersaturated reds and oranges.

Studies have revealed that color may influence our judgments of size, weight and temperature, and even affect our psychological state of mind. Colors are viewed as “high energy” or “low energy.” Cool colors are considered low energy; warm colors are termed “high energy.” Make sure you avoid using two colors that have the same value on the gray scale.

## **BALANCE AND COMPOSITION**

Balance and composition are also important factors when you design television visuals. For full screen visuals, make sure the design is balanced and aesthetically pleasing to the viewer. Try to visualize the final, on-air picture before you use it in a production. An example is the station identification visual shown in figure 14-18.

## **LETTERING**

Letters too small or too thin will not be seen by the viewer. A general rule of thumb is not to use letters smaller than 15 to 20 percent of the essential area. If the visual is too busy or includes too much material, it will probably distract your audience. Five or six lines of 15 to 20 characters is considered the most a viewer can handle at onetime.

## **TELEVISION MICROPHONES**

*LEARNING OBJECTIVE: Recognize the types of microphones used in television productions.*

Sound plays a vital role in the television communication process. Most human intelligence is transmitted through sound; therefore, good quality sound is an important part of television. However, good quality sound is rather difficult to achieve at times because sound sources may be in motion, talent may speak to the camera and not into the microphone and microphones must sometimes be hidden from the view of the camera. To help solve these audio problems, you should have a basic understanding of television microphones.

Microphones are usually classified according to the way they pick up sound, also known as their polar pattern. Sound in physical terms is the vibration of air particles or small fluctuations of air pressure that spread like waves from a source of sound. Human ears respond to this change in pressure within a sound field. Similar to a human ear, microphones respond to the change in air pressure created by sound waves and convert the fluctuations of pressure into electrical current.

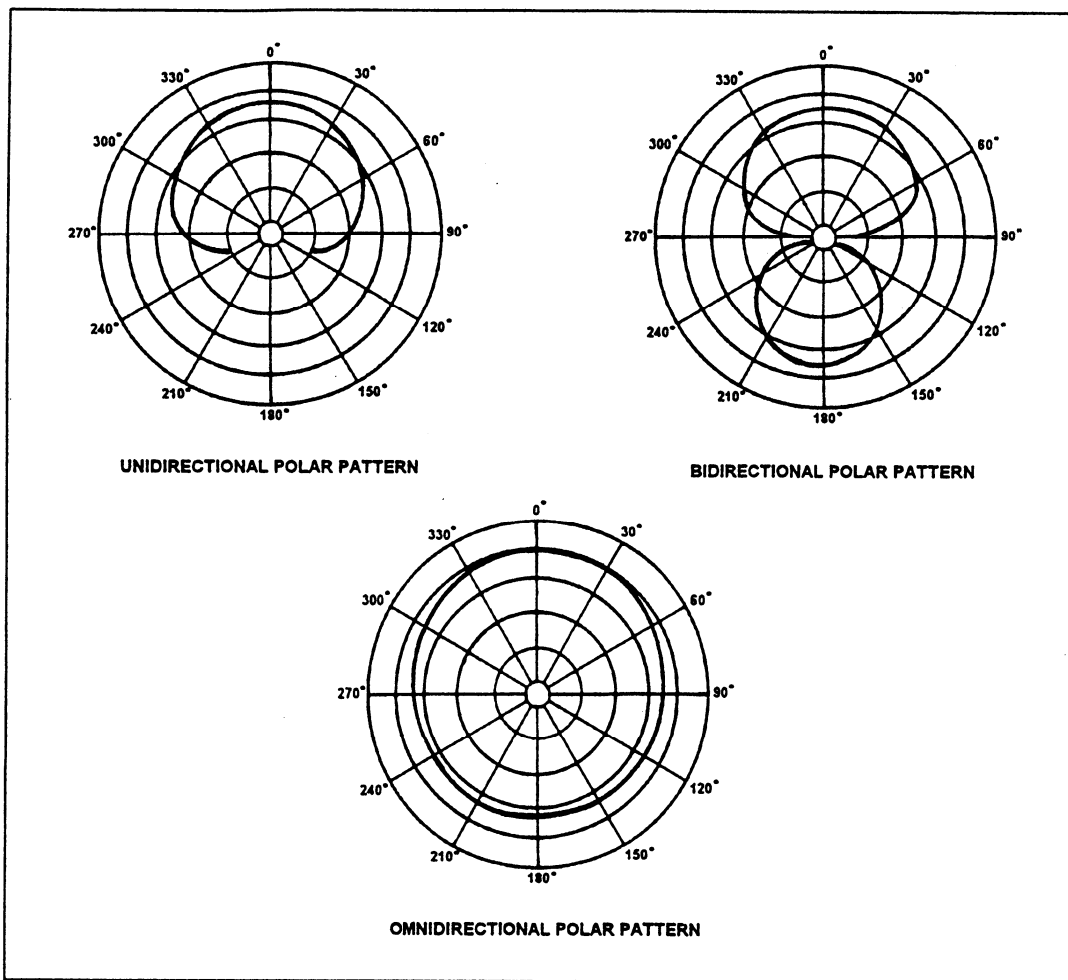

Figure 14-19.—Microphone polar patterns.

## POLAR PATTERNS

The pickup, or polar pattern, of a microphone is the shape of the area around it where it picks up sounds with maximum fidelity and volume. Nearly all microphones can pick up sounds from areas outside the ideal pattern, but their quality is not as good. For best results, the sound source should be within the pickup pattern, generating enough volume to allow the audio switcher to keep the volume control pot at a minimal level.

Microphones are classified according to the following three basic polar patterns:

- Unidirectional
- Omnidirectional
- Bidirectional

### Unidirectional

The unidirectional microphone picks up sound from only one direction. Because of this characteristic, the unidirectional microphone is used most frequently for

television work. It is used by aiming it in the direction of the sound source being recorded. One advantage to the unidirectional microphone is its ability to reject unwanted sounds at the side and rear of the direction the microphone is aimed.

### Omnidirectional

The omnidirectional (or nondirectional) microphone is live in all directions. This type of microphone has sensitivity characteristics in which sound is picked up in a 360-degree radius. The use of this microphone in television production is limited; however, in certain situations, you may use it to create a specific sound presence. One example is recording crowd noise for a sports production.

### Bidirectional

As the name implies, the bidirectional microphone picks up sound in two directions. This type of microphone is used primarily in the broadcast or recording studio. It is also used for critical sound reinforcement applications in which front and rear

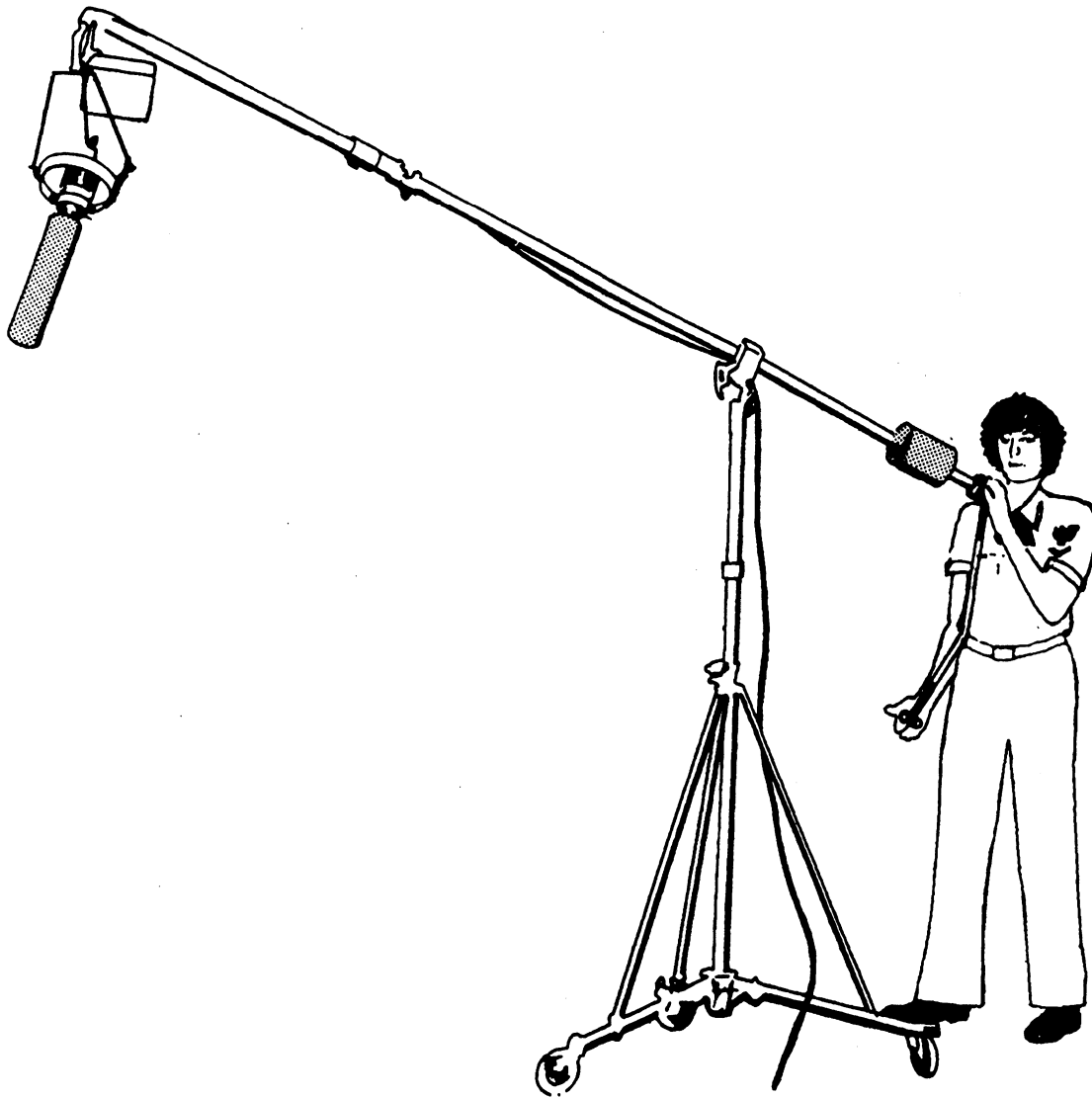

Figure 14-20.—Giraffe boom.

pickup and greatly reduced side pickup are desirable. The bidirectional microphone is ideal for such applications as “across the table” interviews or dialogue recording under studio conditions.

The polar patterns of all three microphones are shown in figure 14-19.

### MOBILE MICROPHONES

During your tour as a television broadcaster, you will use the following four basic types of mobile microphones:

- Boom
- Hand
- Lavalier
- Wireless

### Boom

The most flexible mobile microphone is one that is attached to a microphone boom. A boom, in its simplest form, is a hand-held pole to which a unidirectional microphone is attached. It permits quick and smooth movement of the microphone from spot to spot anywhere on the set. Most booms have a telescoping feature that allows the operator to extend or retract the microphone. Some booms have controls at the end so the operator can rotate the microphone for directional sound pickup.

Another advantage of the boom is its mobility on the set. The boom operator can move the entire boom assembly from location to location and follow sound sources without an interruption to sound pickup. The giraffe boom (fig. 14-20) is suited perfectly for this task.



Figure 14-21.—Hand microphone.

As a television boom operator, your primary responsibility is to keep the microphone as close to the sound source as possible without getting the microphone or its shadow in the picture. This requires coordination and anticipation. You must keep the microphone in front of the sound source, listen to the director's signals, watch camera movements, be aware of what lenses are in use, avoid undesirable boom shadows and anticipate the talent's movement — all at the same time.

### Hand

The hand microphone (fig. 14-21) is used for many television productions, especially ENG shoots. A hand microphone is seen on camera, and therefore, it can be held very close to the sound source. It is especially useful amidst noisy surroundings, such as the flight line or the machine shop aboard ship. In such cases, good audio pickup is still achieved by holding a unidirectional microphone very close to whomever is speaking. A hand microphone is valuable in audience participation programs, such as Navy Relief and Combined Federal Campaign telethons.

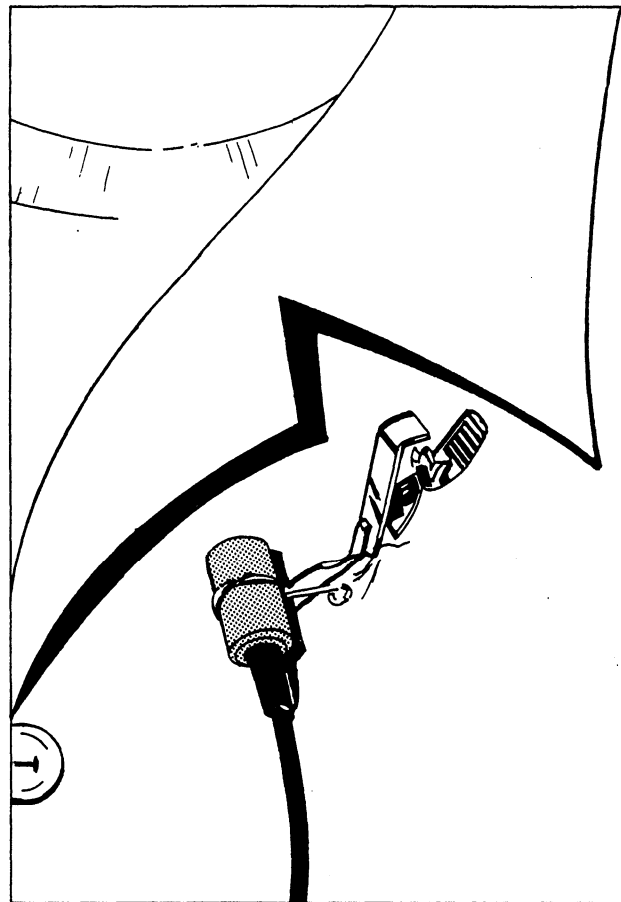

Figure 14-22.—Lavalier microphone.

### Lavalier

During reporter standups, newscasts, interviews and similar production applications, the lavalier microphone (fig. 14-22) is more appropriate than the use of a hand microphone. Lavalier microphones are small and unobtrusive. They are normally taped or clipped to an article of clothing on the talent's chest and are ideal when microphone concealment, individual mobility or the free use of hands is required.

Although concealment is an attractive option of the lavalier microphone, you should not place it entirely under clothing. Clothing acts as a filter and any sound that penetrates the "filter" will be muffled when reproduced. Clothing rubbing against the microphone also can create crackling noises.

Some lavalier microphones are termed *dual redundancy*, because there are actually two lavaliers hooked to the same clip (fig. 14-23). Only one microphone is live, but the other serves as a backup in case the primary microphone fails. For this reason, you



should not connect both microphones to the same audio slider in the audio control room.

### Wireless

The wireless microphone, as its name implies, works without cables. It is a standard lavalier microphone connected to a battery-powered radio transmitter. The talent may clip the transmitter to his belt or conceal it under an article of clothing. A small antenna connected to the transmitter sends the audio signal on an FM frequency to the receiver in the audio control room. The signal is then fed to the audio switcher, who controls the input like any other sound source.

Be careful when you use wireless microphones because they may deliver unwanted audio from radio frequencies (RF) in the area. A wireless microphone receiver and transmitter are shown in figure 14-24.

### STATIONARY MICROPHONES

In addition to the mobile microphone group, you will become familiar with the following four stationary microphones:

- Desk
- Stand
- Hanging
- Hidden

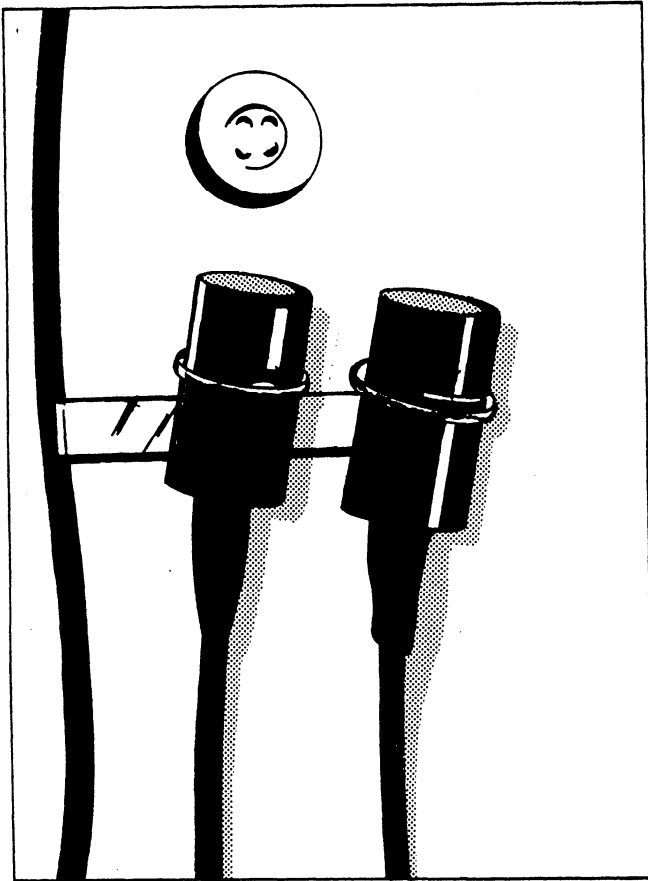

Figure 14-23.—Dual redundancy lavalier microphone.

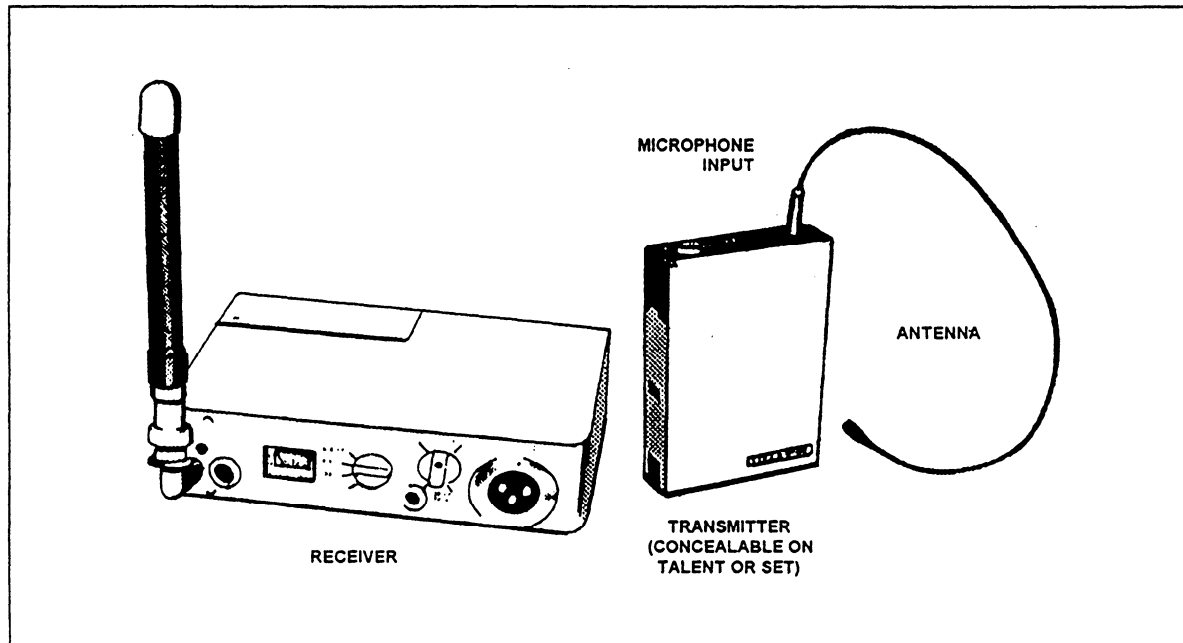

Figure 14-24.—Wireless microphone receiver and transmitter.



Figure 14-25.—Desk microphone.

## Desk

Desk microphones (fig. 14-25) are widely used at public hearings, panel discussions and other productions where the talent is working from behind a desk or lectern. Any microphone can be used as a desk microphone, as long as you attach it to a suitable stand.

Since the talent is heard and seen in television, the placement of the desk microphone is influenced by the camera. If the microphone is placed directly in front of the talent, it may obstruct his face. Further, sound pickup will be influenced when the talent turns his head.

A good starting point for placing the desk microphone is about one and one-half feet from the talent and pointed at his collarbone, as shown in figure 14-26. If the talent turns his head to look at the television monitor or another talent, try to locate the microphone somewhat to that side.

The actual number of desk microphones needed and their placement depends on the quality of the sound produced. If one desk microphone will suffice, then use just one.

You should conceal the cables of desk microphones. If a particular desk or table is used almost exclusively

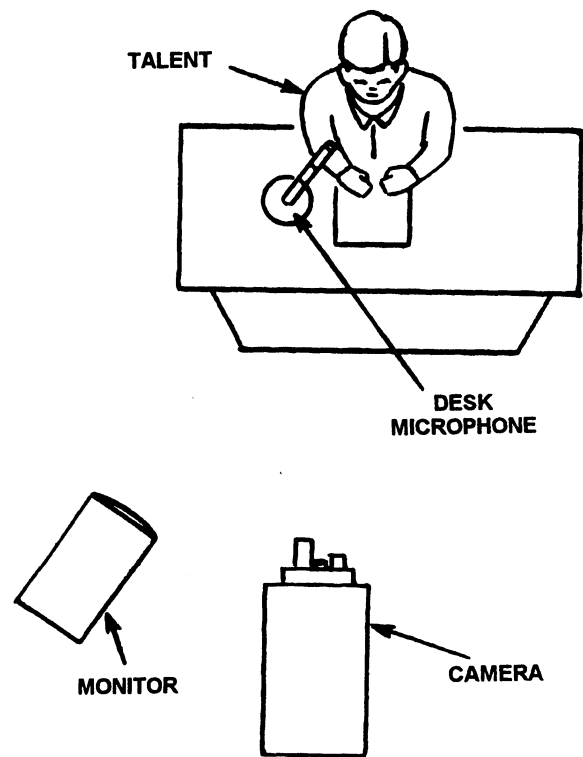

Figure 14-26.—Desk microphone placement.

with a desk microphone, you can drill a hole into its top and drop the cable to the floor.

## Stand

Stand microphones are used when the sound source is immobile and the microphone maybe seen on camera.

For instance, you can use several stand microphones to pickup the sound of a vocal or instrumental group. You may also use a stand microphone for the master of ceremonies (MC).

The placement of stand microphones is determined by sound quality, rather than by picture factors. However, stand microphones should be placed so that they do not impede camera movement or picture quality.

## Hanging

Hanging microphones are often used when a boom microphone is impractical because of lack of space or when a large set will not permit rapid boom movement. It is simply a microphone hung from the ceiling or overhead by its cable, placing it out of normal camera range.

The sound source should be fairly stationary when you use a single hanging microphone. You can use a hanging microphone for panel discussions and other

types of productions where the talent remains immobile at the time of sound pickup. Several microphones located about the set can accommodate moving talents, but the talents must position themselves near the microphone before speaking.

Most hanging microphones do not produce good audio. If placed too close to walls or overheads, an echo or distorted audio is likely to occur.

### Hidden

The sound quality of hidden microphones is mediocre at best, and frequently the object they are hidden in or behind distorts the sound. For this reason, you should use hidden microphones sparingly.

One type of hidden microphone is called a **contact microphone**, because it is in direct contact with the object producing the desired sound effect. An example is a microphone attached to a quick-acting watertight door to pickup the sound of the handwheel and dogs.

## TELEVISION LIGHTING

*LEARNING OBJECTIVE: Identify the principles of television lighting.*

Earlier in this chapter, we noted that the television camera changes various levels of light reflected from objects in the scene into electrical impulses of varying strength. Therefore, the primary objective in any television lighting setup is to ensure sufficient illumination for the correct operation of the television camera. However, at the same time, television lighting must support or even establish the atmosphere of the set or scene.

Television lighting essentially follows the same principles as photographic lighting (Chapter 11). For the sake of clarity, however, we will take a brief look at lighting as it applies to this medium.

### COLOR TEMPERATURE

Before we cover the principles of television lighting, we must address color temperature briefly.

Color temperature is the amount of certain colors that make up a particular white light measured in degrees Kelvin (K). Since the television camera changes images into electronic impulses, the wavelengths of light that vibrate at various frequencies and makeup the different hues or colors will have an effect on the output of the camera.

The simplest way to think of color temperature, without getting into complicated formulas, is to say that

light of a lower color temperature appears more toward the orange end of the scale, while light of a higher color temperature appears more toward the blue end of the scale.

Studio lighting is standardized at 3200°K Daylight sources are balanced in the range of 5000°K to 7000°K You do not have to know what a degree Kelvin is specifically, as long as you accept it as a unit of measure and know how color temperature effects the color television picture.

## STUDIO LIGHTING

In this section, we cover the following factors that contribute to proper studio lighting:

- Three-point lighting (key light, fill light and backlight)
- Use of the f/stop
- Proper lighting intensity
- Proper lighting placement
- Skin tones

### Key Light

The key light (fig. 14-27) serves as the main light source. It provides sufficient light to operate the camera and acts as the reference point for all other lighting. Place the key light in front of the subject and off to the side at about a 45-degree angle, then elevate it 30 to 35

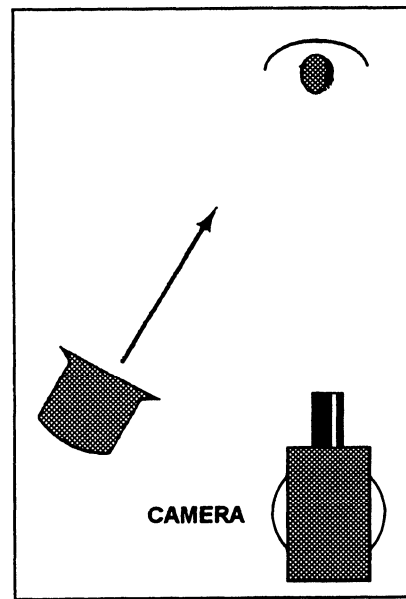

Figure 14-27.—Key light.

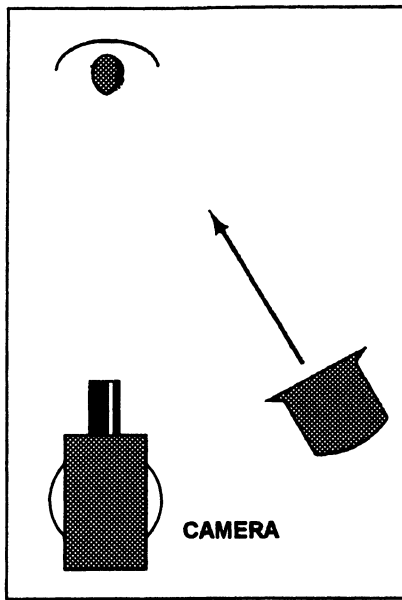

Figure 14-28.—Fill light.

degrees. You may eventually make adjustment for any number of reasons, but this is a good place to start.

### Fill Light

The fill light (fig. 14-28) fills in and softens the harsh shadows created by the key light. Position it on the opposite side of the camera from the key light and elevate it 30 to 35 degrees.

### Backlight

The backlight (fig. 14-29) is used to separate the subject from the background by casting a rim of light across the head and shoulders of the subject. You should place the backlight at an elevated angle, but be careful not to light the top of the subject's head. A good starting point for the backlight is directly behind the subject, elevated 30 to 35 degrees. If your light is mounted on a stand, move it off to the side a little to get the standout of the picture.

### Use of the f/Stop

Like any other camera lens, a television camera lens produces optimum results when stopped down one or two stops from its maximum aperture. Depth of field also is increased by stopping down. Therefore, your lighting should have sufficient intensity so you can stop down for the best picture possible.

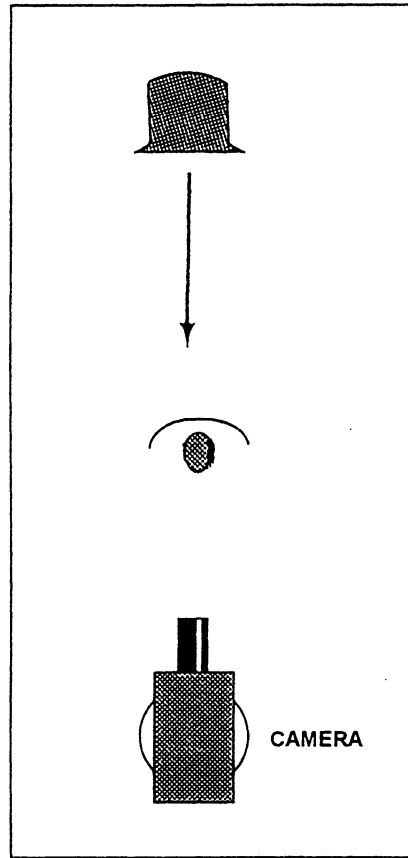

Figure 14-29.—Backlight.

### Proper Lighting Intensity

Lighting in television is as important as lighting in basic photography. It has both artistic and technical aspects. Well-planned and executed lighting produces a clear picture with outstanding contrast and depth.

Most television cameras are capable of operating in very low-light levels. However, shooting in dim light may give you video noise and be of generally poor quality.

### Proper Lighting Placement

When you set up lighting for a live television production, remember that these productions are continuous; therefore, you must make sure that the lighting you use will be effective from every angle the camera sees in the program. You do not have the luxury of stopping to readjust lighting for each shot. You must make sure that the lighting fixtures and cables do not interfere with the free movement of the cameras. As always, you must plan ahead to avoid embarrassing pitfalls, and then let your television monitor be your

guide when making additions to, and subtractions from, your lighting setup.

### Skin Tones

Because skin tones are the only “true” means by which a viewer can adjust the color balance of his television set, it is obvious that skin tones must be reproduced accurately and naturally. Proper lighting is the chief way of accomplishing this task.

One way of reproducing natural skin tones is to light the set evenly. If a talent moves from a light scene to a dark scene, the talent’s face should be kept as evenly lighted as possible. The difference between the dark scene and the light scene should be accomplished through backlighting and not the lighting on the talent.

Since extreme shadows take on their own color, you should avoid casting them on the face of the talent. However, do not eliminate facial shadows altogether. Lighten them with fill light instead. A certain amount of shadows are necessary to give character and dimension to the face.

Do not permit color reflections from clothing or scenery to fall on the talent’s face. Likewise, avoid the use of colored lights to light the talent (except for special effects). Save the colored lights for lighting the background.

### ENG LIGHTING

When you leave the confines of the television news room or production studio for an ENG assignment, your main concern will be the availability of lights. If you are outdoors on a sunny day, there is not much of a problem. But when you move indoors or shoot at night, you will need a portable, lightweight and versatile lighting system that either runs on batteries or plugs into a wall outlet without blowing fuses.

Before we cover the components of ENG lighting, keep in mind that the television lighting principles previously covered also apply to ENG lighting.

### Portable Lighting Kit

Portable lighting kits will supply you with the lighting equipment you need in most situations. They normally include the following pieces of equipment:

- Lighting instruments
- Tripods
- Short power cables
- Battery packs for each light

- Accessories

Additionally, you may want to include a set of insulated gloves, heavy-duty masking tape or gaffer’s tape and at least one extra bulb for each lighting instrument.

There are many commercially available selections of ENG lighting kits. They usually provide at least enough instruments and accessories for your basic lighting needs.

The color temperature of ENG lighting kit instruments is 3200°K. They are usually variable-focus lighting instruments that may be adjusted for use as a key, fill or backlight.

### Accessories.

Your light kit should contain accessories, such as barn doors, screens and scrims (fig. 14-30). They are covered in the following text.

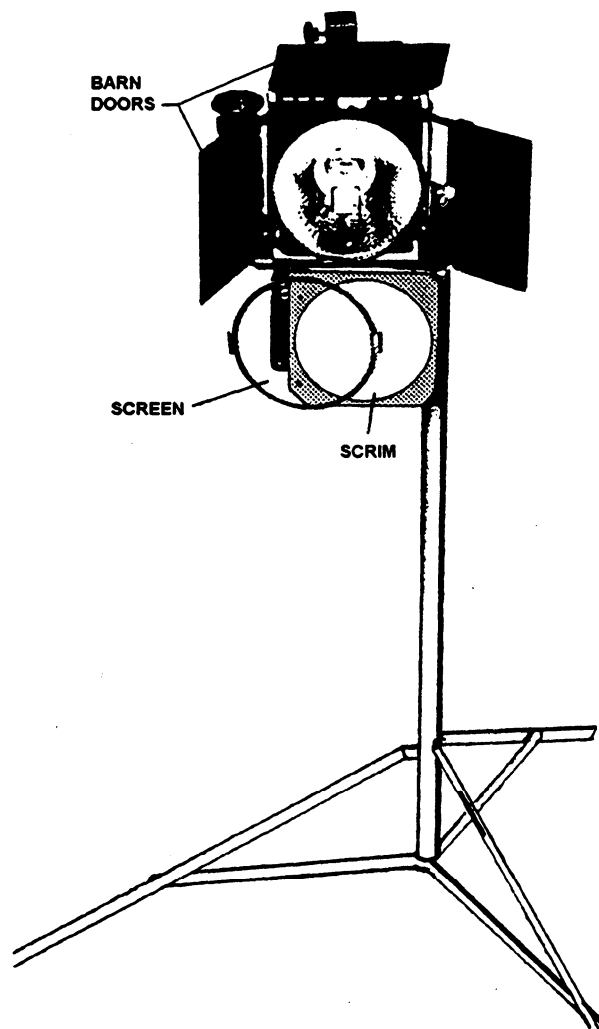

Figure 14-30.—Barn doors, screen and scrim.

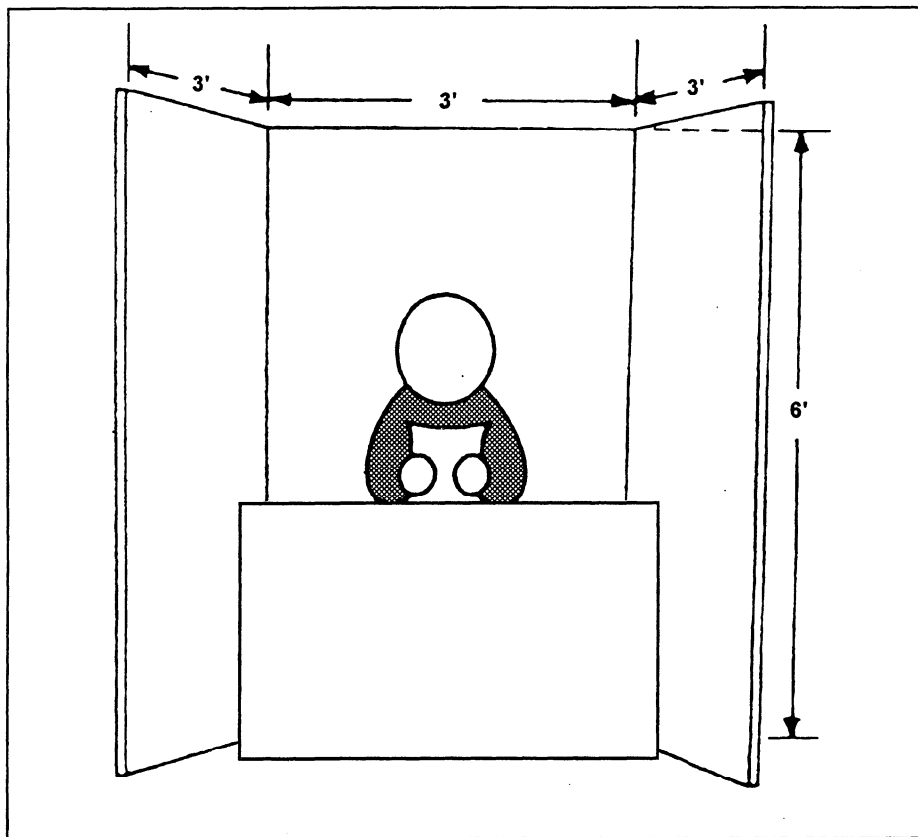

Figure 14-31.—Basic television set.

**BARN DOORS.**— Barn doors are metal flaps attached to a ring that is connected to the body of the lighting instrument. They come in either two- or four-door versions. Depending on the type of barn door, you can open or close the doors at the top, bottom or sides to crop the light.

**SCREENS.**— Screens are small, round or square pieces of metal screening, placed in front of the light to reduce its intensity. They do not change the color temperature of the light. Use screens to reduce or eliminate strong shadows.

**SCRIMS.**— Scrims are made of clear spun glass or gauze used to diffuse and soften a light. They decrease the intensity of a light without affecting its color temperature.

## THE TELEVISION SET

*LEARNING OBJECTIVE: Recognize the components of a basic television news set.*

All television sets must be designed for the television camera. Everything about the set — size,

color, location and props — must be adapted specifically to what the camera sees. A set can be as simple as hung drapes or as complex as a full-scale replica of a ship. However, its actual form must fulfill the artistic aim of orienting the viewers to a place, time or mood.

Just how elaborate your set will be is determined by a number of things, such as the space and materials available, and the manpower you have to design and construct the set.

There are many books on the subject of set design and construction. However, in this chapter we are limiting ourselves to simple set designs that are suitable for use aboard ships and small NBS detachments.

Ideally, you should build an all purpose set — one that is easy to handle and adaptable to a variety of production uses. One set you should consider consists of three 3- by 6- or 4- by 8-foot plywood panels, each 1/4 inch thick. Around the back edges are nailed or screwed 2-by 2-inch furring strips (structural supports) to give it stability (fig. 14-31).

The panels should be hinged together with a type of hardware that allows them to be separated from each

other. Paint the panels flat light blue or green, which will make the skin tones look more natural on color television. To reduce glare and reflections from studio lights, you should use flat latex paint.

Before painting the panels, you should check your color choices. Paint small squares of wood and compare them on camera. There must be a distinct difference between set tone and skin tone in order to provide adequate contrast without being excessive. Make sure you select a color that provides suitable contrast when used with either dark or light skin.

## SET ERECTION

When you erect a set, you should consider the following three production areas:

- **Camera and microphone boom movement.** The camera support and microphone boom must be allowed space on the set in which to move. This is especially important for camera angle or position changes and for recording quality sound.
- **Talent movement.** The talent must have free access if he moves around the set.
- **Lighting.** The set must provide sufficient lighting for the camera(s).

## CREATING THE ENVIRONMENT

A set is used to create the environment or mood of the scene and must be appropriate to the purpose of the program. Sets are generally divided into the following three categories:

- Natural
- Realistic
- Fantasy

### Natural

A natural set does not represent any specific locale or period and could be, for example, a plain gray background. This type of set can be used for a training program, because there are no background distractions.

### Realistic

Realism can be achieved in three ways. An exact copy of a period or original scene would be a *replica*, while a setting portraying a type of scene, such as an early sailing ship, is *atmospheric*. The suggestion of an

office by the use of a desk and chair, or the shadow of a branch to suggest a tree, is *symbolic*.

## Fantasy

The use of abstract shapes or textures can create character and mood. Unrealistic settings have no direct relationship to the real world, but suggest to the viewer a feeling or sense of the location or time.

## TELEVISION SHOOTING TECHNIQUES

*LEARNING OBJECTIVE: Identify the basic television shooting techniques.*

Television pictures are subject to the aesthetic rules covered in Chapter 12. In fact, because of the wide usage of television, it can even be considered the standard by which we judge most picture composition. However, the following factors unique to television influence picture composition to a certain extent:

- **Small television picture size.** Because of the relatively small size of the television screen, objects must be shown relatively large.
- **Inflexible aspect ratio.** The 3:4 aspect ratio of the picture cannot be changed and all picture elements must be composed to fit it.
- **What the camera sees is what the viewer gets.** The television camera serves as the viewer's eyes; therefore, camera movement, as well as the static arrangement of elements within the frame, must be considered.
- **Time constraints.** Because of the time limitations placed on all television productions, you may not be able to predetermine composition, especially during a live show. Sometimes, all you can do is correct certain compositional errors.

In the television business, the picture on the screen is referred to as a *shot*. A shot may change when either the camera or talent moves. Shots can last for only a few seconds or be as long as a minute or two. In extreme cases, one shot can last the entire program.

As a television camera operator, you must think in terms of shots and master the basic shots of television production.

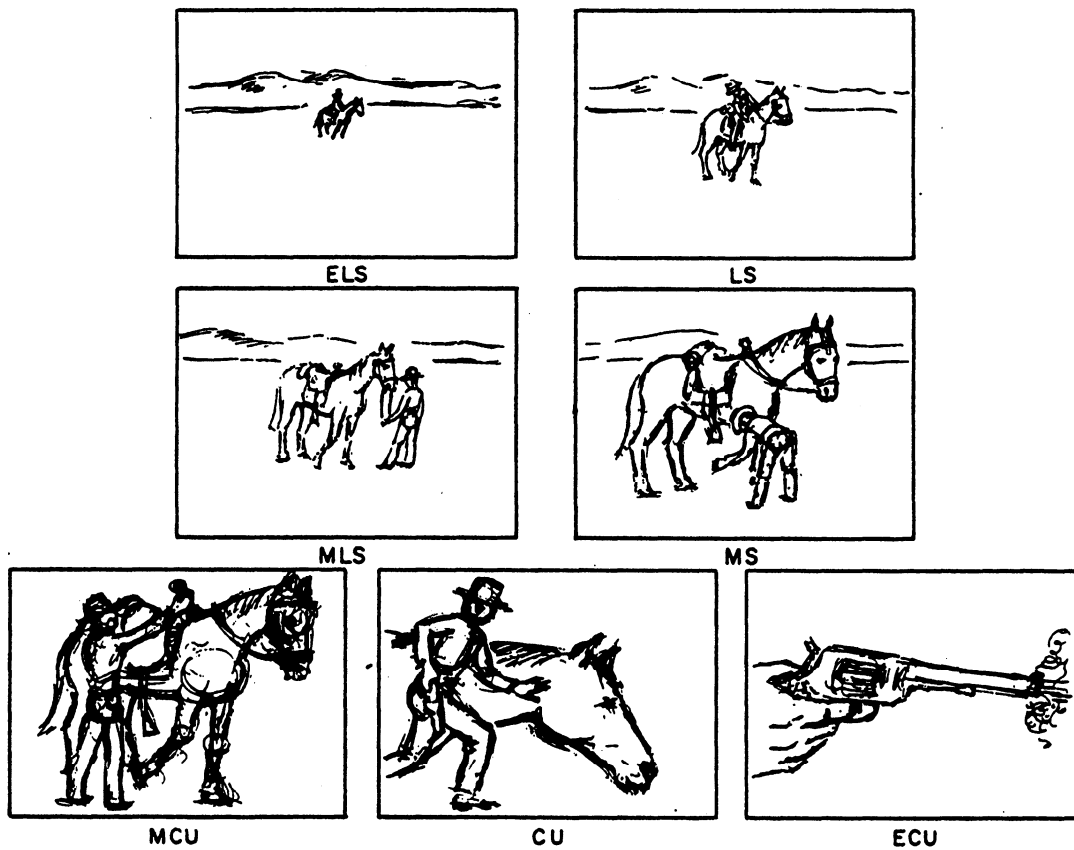

Figure 14-32.—Television shot classification.

## SHOT CLASSIFICATION

Shots for television (fig. 14-32) are classified in the following manner:

- Extreme long shot (ELS)
- Long shot (LS)
- Medium long shot (MLS)
- Medium close-up (MCU)
- close-up (CU)
- Extreme close-up (ECU)

Using these terms is the most convenient way for the director to call for the type of shot he wants the camera operator to shoot.

By examining the purposes of the long shot and close-up, you can get an idea of the functions of the other shots. The long shot is used to show as much of the subject as possible while still keeping it recognizable. It is used primarily to show the audience the overall appearance of the whole subject and the subject's relationship to each of the scene elements. This is

important, because in subsequent shots (except the extreme long shot), only a relatively small part of the scene will be presented to the viewers. In television work a long shot is used to orientate the viewers or establish the scene.

The close-up is probably the best television shot. It is one of the most efficient compensations for the small size of the television screen and it is essential to creating intimacy and getting the viewer "into" the picture. Close-ups are, and should be, one of the most widely used shots for television. The director calls for a close-up for many purposes, the most common of which is to direct the viewer's attention to a specific object or facial expression.

The extreme long shot and extreme close-up are used to describe shots that include an even greater area or a more limited area, respectively. For example, in figure 14-32, the extreme long shot shows the main subject of the scene as a very small mass surrounded by a vast expanse of background and foreground. Consequently, the extreme close-up shows only the cowboy's finger pulling the trigger to discharge his weapon.



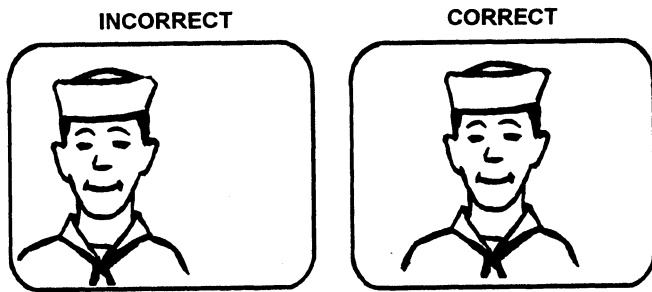

Figure 14-33.—One-talent framing.

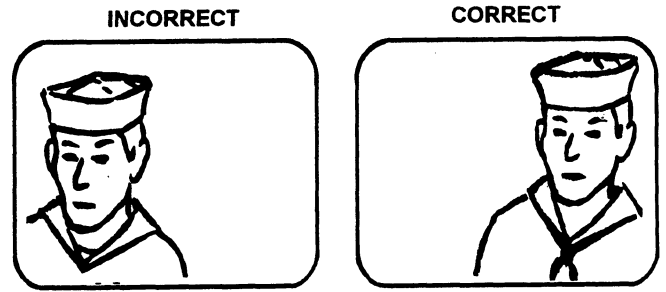

Figure 14-35.—Framing talent looking left or right.

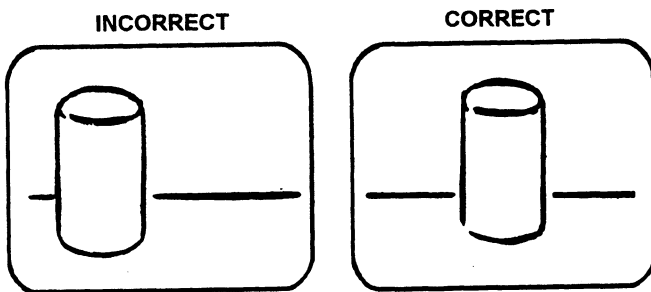

Figure 14-34.—Single-object framing.

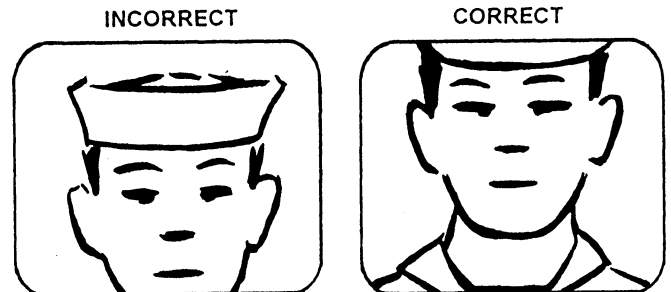

Figure 14-36.—Framing talent (extreme close-up).

## FRAMING

In the following coverage of framing for television, we will not dwell on photographic composition, because it was addressed in Chapter 12. Instead, we will show you simple line drawing examples of television framing to show you how to present elements within the small 3:4 fixed aspect ratio of the television picture.

Use the following guidelines when you frame subjects or objects:

- **One-talent framing.** When only one talent is talking directly into the camera, place the talent in the middle of the picture to give him maximum emphasis (fig. 14-33).
- **Single-object framing.** When you shoot a single object, frame it directly in the middle of the picture (fig. 14-34).
- **Framing talent looking left or right.** When the talent looks left or right, give him space within the picture to look (fig. 14-35).
- **Framing talent (extreme close-up).** When you want an extreme close-up of the talent, crop space at the top of his head, not the bottom (fig. 14-36).

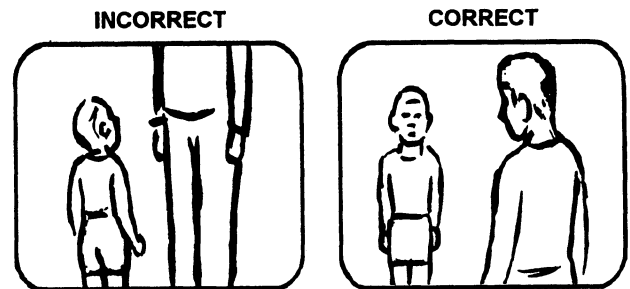

Figure 14-37.—Framing talents of different heights.

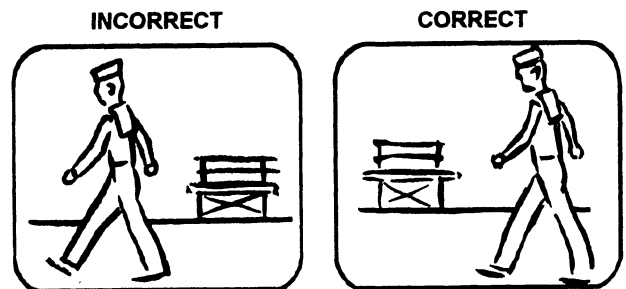

Figure 14-38.—Framing a moving talent.

- **Framing talents of different heights.** When you frame talents of different heights, do not cut the head off one or the other (fig. 14-37).
- **Framing a moving talent.** When you frame a moving talent, give him room in which to move (fig. 14-38).

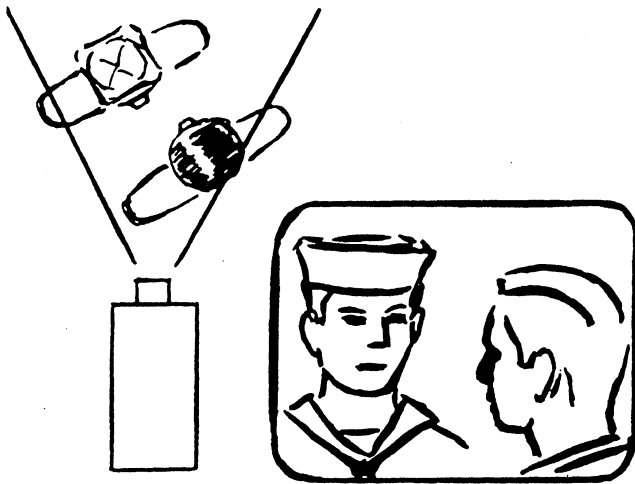

Figure 14-39.—Framing multiple talents.

- **Framing multiple talents.** When you frame multiple talents, such as a “two-shot,” position the camera as shown in figure 14-39. This helps to establish a relationship between the talents.
- **Framing multiple talents with two cameras.** When you frame multiple talents using two cameras, keep the cameras on the same side of the “action axis” shown in figure 14-40. This will prevent the reversal of screen direction in the picture.

Use high and low camera angles with caution. High angles tend to foreshorten legs, while low angles may distort the body and face. Additionally, be aware of set areas or props that seem to be growing out of, or balanced on, a talent’s head (fig. 14-41).

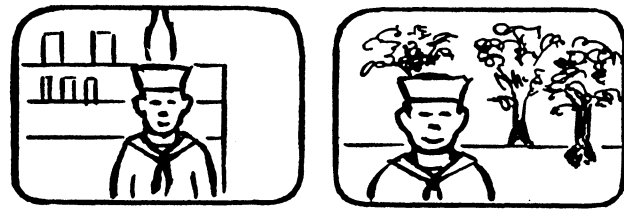

Figure 14-41.—Improperly placed prop and set area.

#### AREA OF TALENT INCLUDED

The majority of your television pictures will be of people. Accordingly, it is convenient to identify people shots in terms of the portion of the body to be included in the frame.

To help you recognize image size and to frame your talent effectively, you should use the cutoff line system (fig. 14-42). Cutoff lines are natural dividing lines that will help you produce aesthetically pleasing shots.

Use the cutoff lines in the same manner as the six shot classifications previously covered.

#### NUMBER OF TALENTS INCLUDED

The shot designations that are easiest for you to remember are the ones that refer to the number of people to be included in the picture. When you shoot only one talent, it is termed a **one-shot**, two talents is a **two-shot**, three is a **three-shot**, and so forth. However, when five

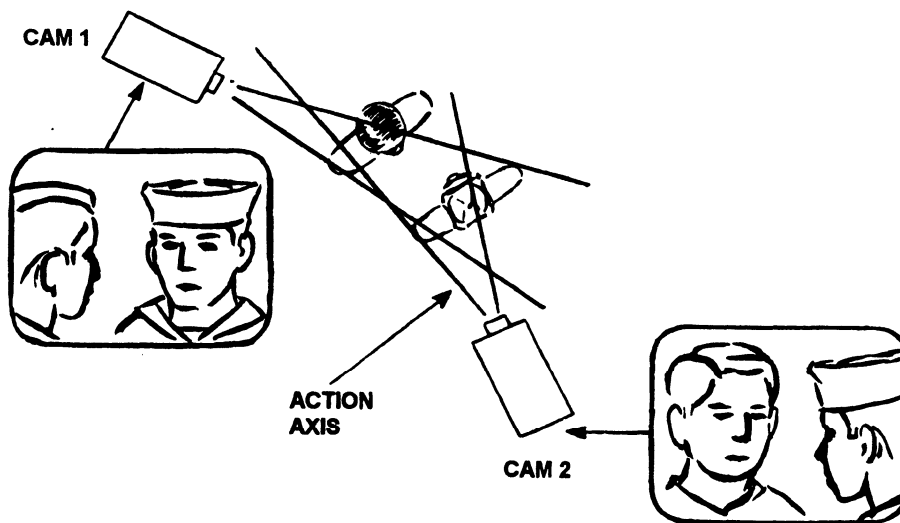

Figure 14-40.—Framing multiple talents with two cameras.

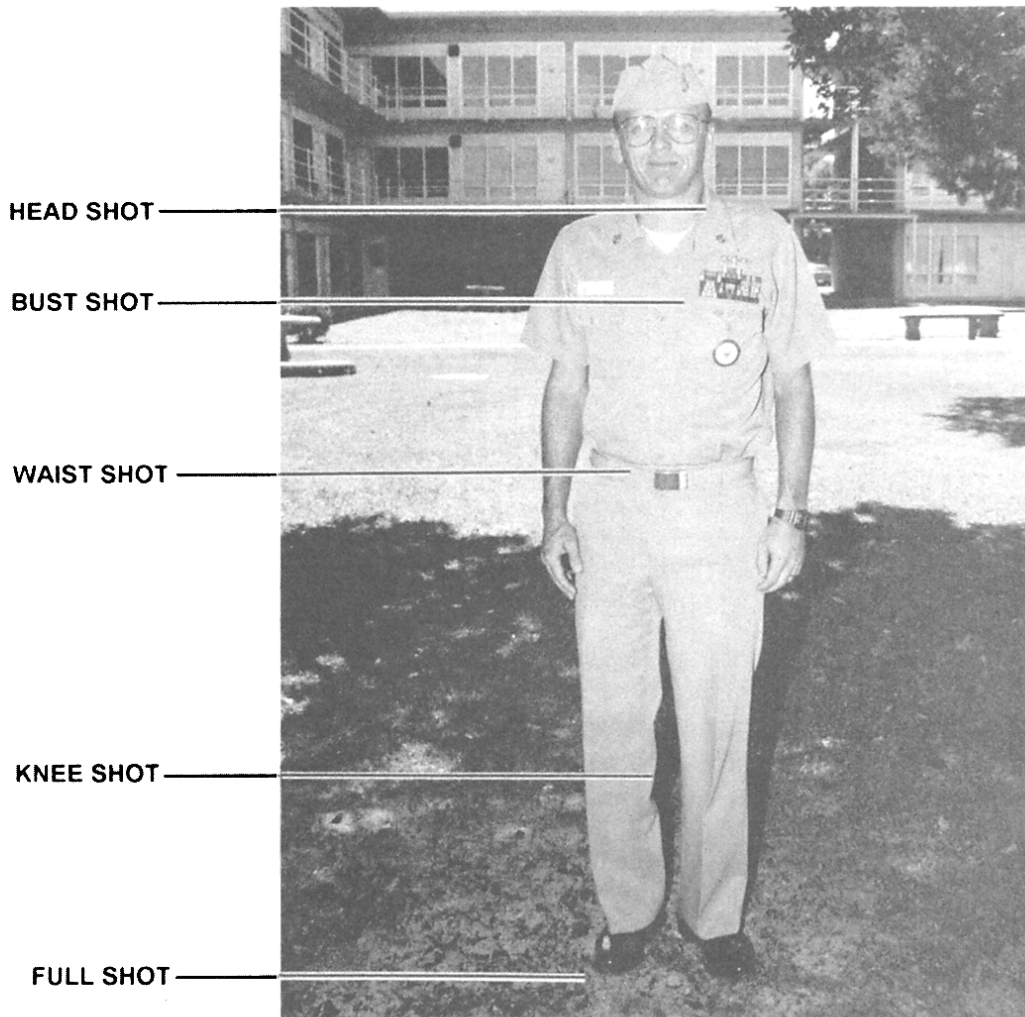

Figure 14-42.—Cutoff lines.

or six people are pictured, it is referred to as a **wide** or **long shot**

## MOVEMENT

Good television needs movement — movement in front of the camera, movement of the camera itself and movement of the picture itself (one picture replacing another).

The movements necessary for good television are divided into the following three categories:

- Primary movement
- Secondary movements

- Tertiary movement

### Primary Movement

Movement in front of the camera, usually by the talent, is referred to as primary movement. Primary movement toward or away from the camera is stronger than lateral movement, thus creating more emphasis. Exits and entrances are more impressive when they occur toward or away from the camera.

Remember: you should always lead the lateral movement of the talent with your camera. The viewer wants to know where the subject is going, not where he has been.

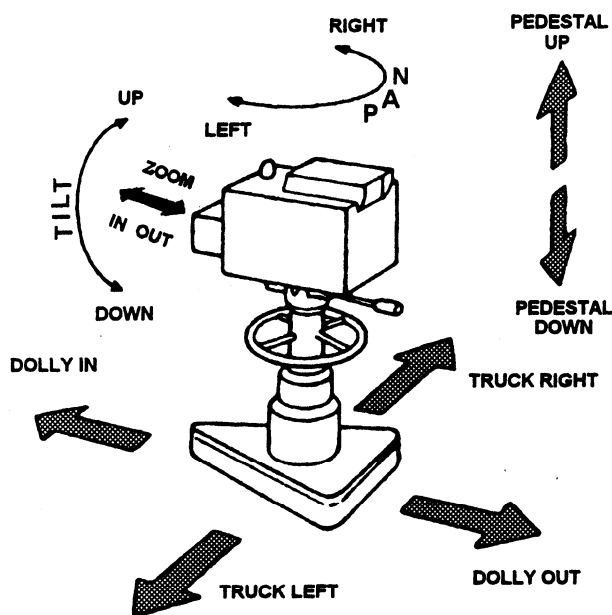

Figure 14-43.—Secondary movements.

## Secondary Movements

Secondary movements (fig. 14-43) may be used to follow primary movements or to change or adjust picture composition. You also may use them to emphasize or dramatize a certain portion of a production.

The secondary movements you will become familiar with are as follows:

- Pan
- Tilt
- Dolly
- Zoom
- Truck
- Pedestal

**PAN.**— A pan is simply the horizontal movement of the camera on a stationary pedestal used to follow primary action. When panning, you should try to avoid “dead space” between subjects. Do this by positioning the talents diagonally instead of laterally, as shown in figure 14-44. From the point of view of the camera, diagonal staging brings the talents closer together.

When the director wants a pan, he will call for **pan left** or **pan right**.

**TILT.**— Tilting is simply pointing the camera up or down. The reasons for tilting the camera are similar to

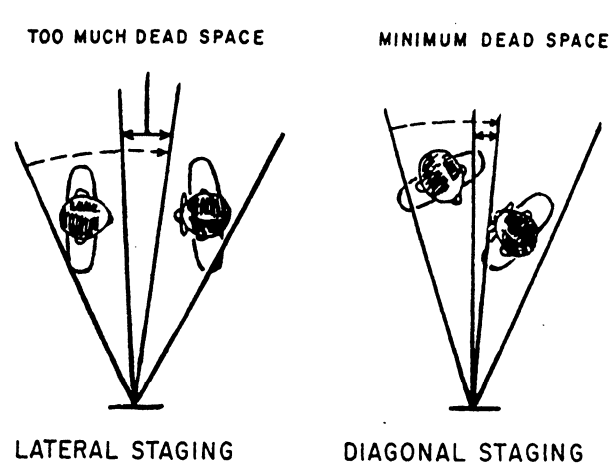

Figure 14-44.—Lateral vs. diagonal staging of talent.

those for panning the camera. For example, the height of an object can be shown by gradually tilting up on it, or you could tilt down on something to build suspense.

The director usually indicates to the camera operator the tilt he wants by ordering **tilt up** or **tilt down**.

**DOLLY.**— Dollying is moving the camera toward or away from the subject. You can dolly in to increase gradually the size of an object on the screen, or dolly out to produce an opposite effect. Likewise, dollying decreases or increases the field of view.

The director’s orders for dolly are **dolly in** or **dolly out**.

**ZOOM.**— A zoom is made with a zoom lens. It looks like a dolly and is used for the same purpose. During a zoom the camera does not move; therefore, perspective does not change as it does during a dolly.

The director orders **zoom in** or **zoom out**.

**TRUCK.**— Trucking is the lateral movement of the camera. It is used to follow lateral subject movement or to truck the camera parallel to stationary objects. In either case, camera-to-subject distance does not change.

**Truck left** or **truck right** are the director’s orders to the camera operator.

**PEDESTAL.**— When the director calls for a pedestal, the entire camera is either raised or lowered on the pedestal. Pedestaling can provide the audience with a high or low perspective of the subject. The pedestal also can be used to compensate for tall or short camera operators or talents.

**Pedestal up** or **pedestal down** are the director’s commands.

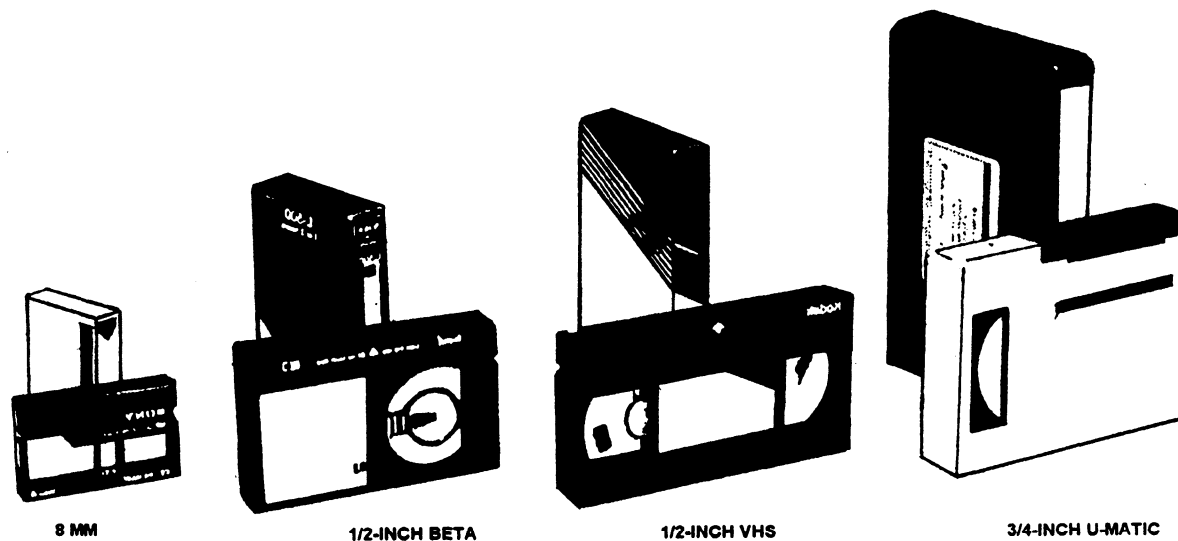

Figure 14-45.—Videotape formats.

Keep in mind that secondary movements must have a valid purpose. Do not make them arbitrarily.

### Tertiary Movement

Tertiary movement results from a sequence of shots from two or more cameras. When two or more cameras are used the director can select from a variety of pictures to determine what picture will be telecast and at what time. When more than one camera is used, the director can easily emphasize, de-emphasize or show action and reaction in rapid or slow succession.

## VIDEOTAPE EDITING

*LEARNING OBJECTIVE: Recognize the fundamental procedures of editing videotape.*

When videotape technology was in its infancy, there was only one way to eliminate unwanted shots — physically cut the tape and splice it back together. This method produced edits that were crude at best, because videotape recording is strictly an electronic process.

Today, the complicated process of cutting and splicing videotape is all but a forgotten art. Now you can edit videotape quickly and cleanly through the use of videotape editing systems.

### VIDEOTAPE FORMATS

Before we examine the actual videotape editing process, it is important for you to understand that videotape comes in several different formats. Currently, there are a number of videotape formats used in the

broadcast industry, including 3/4-inch U-Matic, 1/2-inch VHS, 1/2-inch Beta and 8mm, also called Hi8 (fig. 14-45).

There are different schools of thought as to which formats are broadcast quality and which are not, but it is universally accepted that the 3/4-inch U-Matic and 1/2-inch Beta are industry standard. These formats are the ones most commonly used at NBS detachments.

Keep in mind that VHS tapes cannot be played on Beta videotape machines, and vice versa (even though they both contain 1/2-inch videotape). Likewise, 3/4-inch U-Matic tapes can only be played on 3/4-inch U-Matic machines and Hi8 tapes are compatible only with Hi8 tape decks.

### VIDEOTAPE TRACKS

The electronic information found on a videotape is on the following four tracks:

- Video
- Audio
- Control
- Time code address

#### Video Track

The video track takes up about three-quarters of the space on a videotape. It is recorded as a series of diagonal lines by one or two rapidly spinning tape heads on the head drum of the VCR.

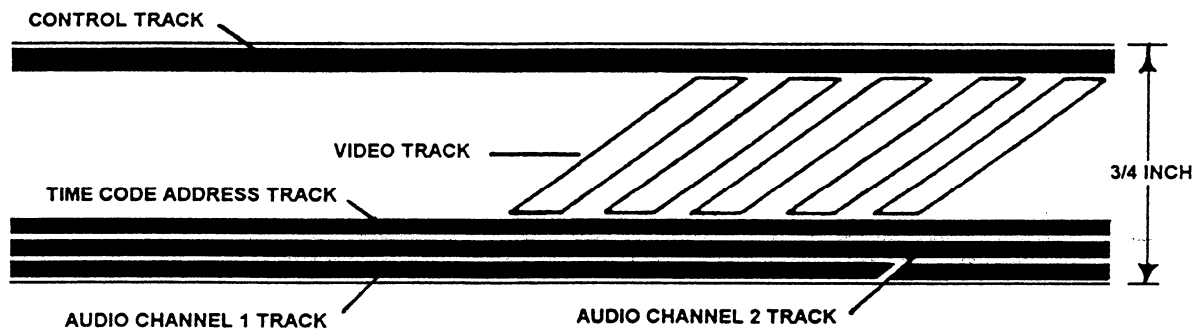

Figure 14-46.—Track location on a 3/4-inch U-Matic videotape.

### Audio Track

Virtually all formats of videotape provide at least two distinct areas for the recording of audio information. They are placed in different locations on the videotape but perform the same as regular audiotape.

### Control Track

The control track consists of electronic blips or spikes, called sync pulses, recorded in precise intervals of one-thirtieth of a second. Since it provides the necessary foundation for the editing process, **you cannot edit without a control track on your blank (source) tape in the insert edit mode.** The insert edit mode is explained later.

Laying the control track on a blank videotape is the first step in the videotape editing process in the insert edit mode. Most television studios have a “black burst” generator that produces a crystal black signal you may record and use as a control track. You also can record a control track from another tape — for example, a tape that has color bars and tone.

### Time Code Address Track

The time code address track is used to record timing information for editing. This information may consist of audio or visual time/frame identification.

Figure 14-46 shows the location of all four tracks on a 3/4-inch U-Matic videotape.

## VIDEOTAPE EDITING PROCESS

Videotape editing is essentially a transfer process in which a playback VCR, containing the recorded segments, transfers its material onto an edit/record VCR that assembles the various segments into a finished form. The editing control unit (ECU) is equipped with

highly sophisticated electronic circuitry and allows the operator to control exactly where the old material on the edit/record VCR will end and the new material playing in from the playback VCR will begin.

The precision of the edits depends largely on your reaction time and skill. You must precue both videocassette tapes accurately before the editing begins, since you will control exactly where and when the edit will occur while the two VCRs are rolling.

You will do your editing in what is called an editing cell. Most NBS detachments have two or more editing cells containing the following equipment:

- Playback VCR
- Edit/record VCR
- Television monitor for the playback VCR
- Television monitor for the edit/record VCR
- Audio mixer
- ECU

A typical editing cell is shown in figure 14-47.

## EDITING MODES

On an editing cell, you may make either assemble edits or insert edits. Both are explained in the following text.

### Assemble Edits

In the assemble editing mode, the ECU adds control track and program footage (both audio tracks and the video track) to the edit/record VCR at a predetermined in-edit point. The edit/record VCR continues recording the new information and the control track until it is stopped. When you are assemble editing, you are inserting a new control track at each in-edit point and

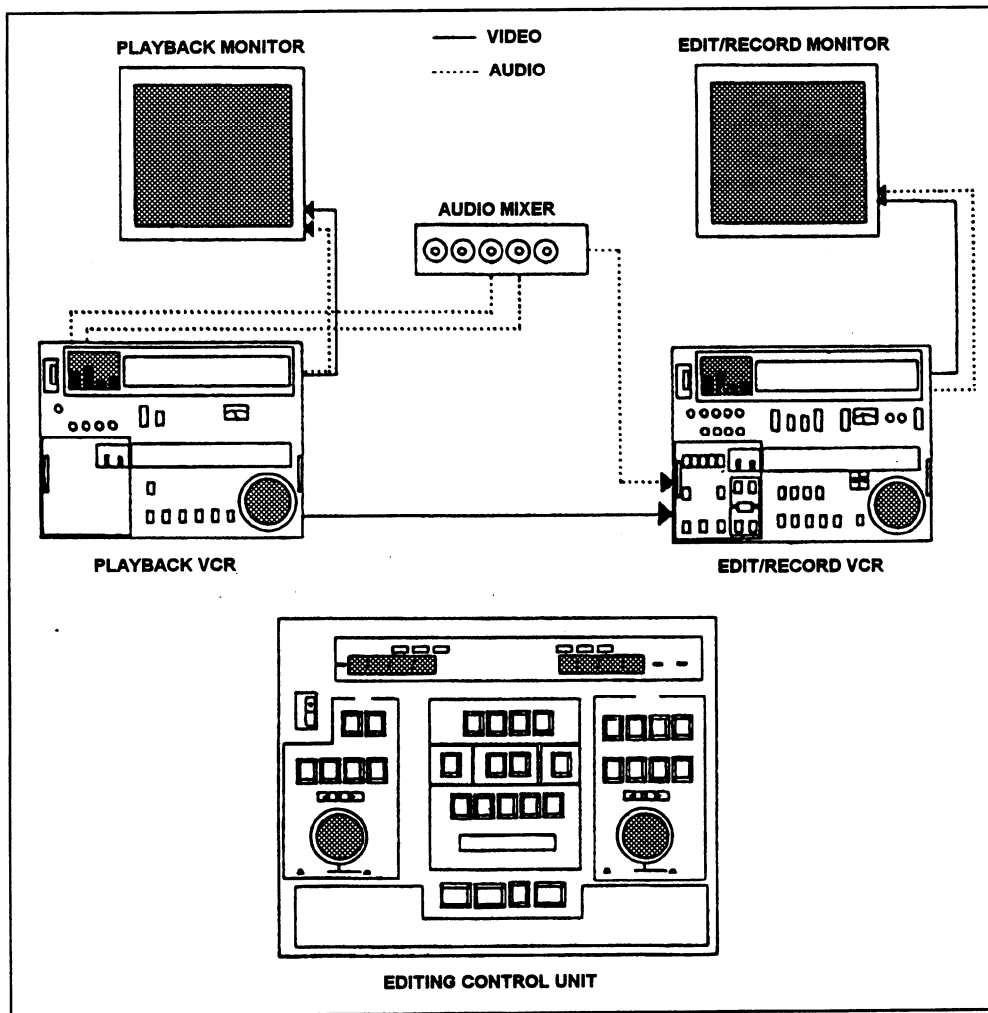

Figure 14-47.—Videotape editing cell.

ending a control track at each out-edit point. Your video may be unstable (picture tearing or breakup) at the edit points during playback. Therefore, you should allow for extra video after your intended stop/out-edit point — otherwise, you will not be able to edit onto the last part of the video. Assemble edits are very convenient because you simply add segments to build the video story or program.

### Insert Edits

Insert editing allows you to add or change video or audio separately or together without affecting the control track. As you insert the new material over the existing information, you use the control track already established on the edit/record videocassette to lock the signal into synchronization.

The main drawback of insert editing is that you must lay along enough control track on the tape before you

start editing. A one-hour program tape requires you to lay one hour of black or color bars and tone before you start the editing process.

**NOTE:** After laying the control track in the assemble mode, be sure to switch to the insert mode on the ECU. If you remain in the assemble mode when you make your first video or audio edit, the end of the edit will look like a green flicker on the television monitor. This is caused by a break in the control track. There is no way to correct this break without relaying the control track for the entire length of the tape. The best approach for you to take is to stay in either the assemble or insert

### EDITING TECHNIQUES

The two basic editing techniques in videotape editing are **continuity cutting** and **compilation cutting**. Both are explained in the following text.



Figure 14-48.—Cutaway.

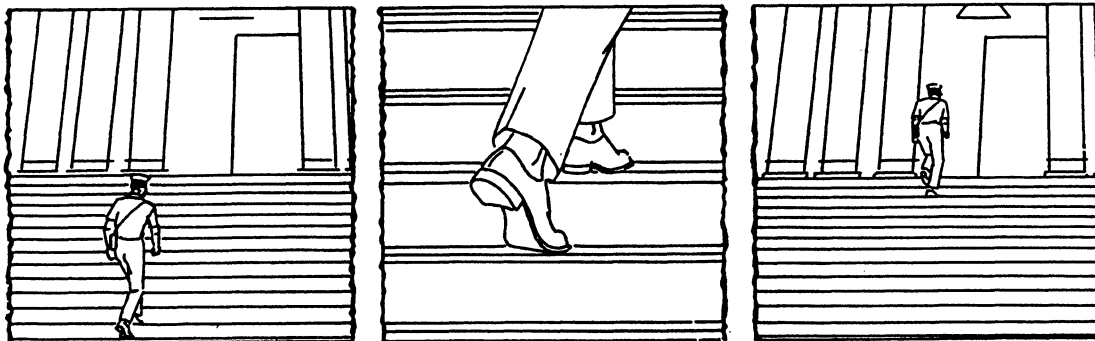

Figure 14-49.—Cut-in.

## Continuity Cutting

Continuity cutting is the most commonly used method of editing videotape for news or feature releases. It is used when the storytelling is dependent on matching consecutive scenes. Continuity cutting consists of matched cuts in which continuous action flows from one shot to another.

The three transitional devices associated with continuity cutting are the **cutaway**, **cut-in** and **crosscutting**.

**CUTAWAY.**— When the action shown is not a portion of the previous scene, a transitional device, known as a cutaway, is used to change positions, movements or characters or to denote a lapse of time. This eliminates a mismatch, or jump cut, that would cause the segment to appear jerky or out of sequence. Cutaways are often termed *protection*, *reaction*, *insert* or *cover shots* and are thought of as secondary action shots.

For example, if the main thought is centered around a parade, cutaways might consist of closeup shots of the crowd. Children may be shown watching intently, eating

candy or applauding; adults may be wearing different expressions of emotion or carrying children on their shoulders (fig. 14-48). These shots are of human interest and are related to the main story, but are not actually a primary part of it.

If you have a good selection of cutaways, often you can make a marvelous story out of an otherwise drab and commonplace event. The cutaway can cover a multitude of camera operator errors and result in the formulation of an exciting segment.

Cutaways should last between three and five seconds.

**CUT-IN.**— Another method used to denote a lapse of time is the cut-in. Unlike the cutaway, the cut-in is a part of the primary action, rather than the secondary action. For instance, to denote a person climbing a long flight of stairs, you establish the individual at the start of the climb, then cut to a close-up of feet as they take the steps. After you establish the shot (three to five seconds), you cut back to the person at the top of the stairs (fig. 14-49). A person can appear to walk a city block in just a few seconds by showing feet walking or a hand carrying a briefcase.



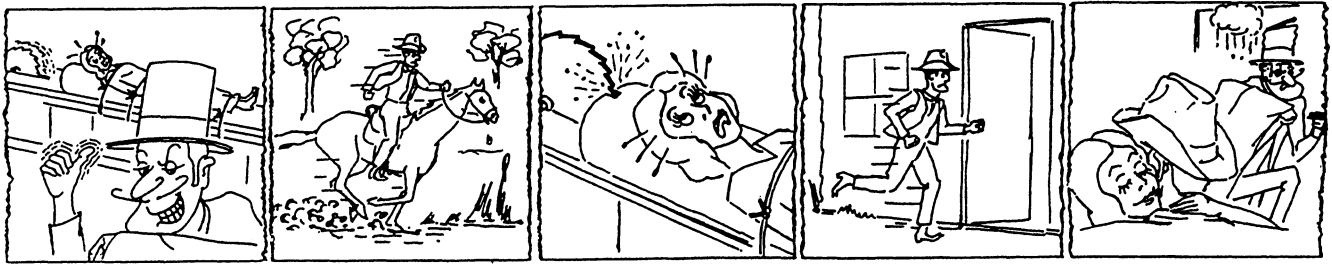

Figure 14-50.—Crosscutting.

**CROSSCUTTING.**— Crosscutting is the old standby of videotape editing. In crosscutting, you use shots from two different actions or events that will finally be related. A time-honored example is the “meanwhile, back at the ranch” style, or the hero riding hard to save the life of the heroine who has been chained to a buzz saw by the villain (fig. 14-50). The action would be cut back and forth between the desperate rider and the saw as it comes dangerously close to the heroine’s head, showing the progress of each, then finally relating them as the rider arrives at the last moment to save the heroine.

### Compilation Cutting

The second method of videotape editing is compilation cutting. This is used in documentary-style stories of surveys, reports, history or travelogues. Segments are tied together through narration. The narrative explains the shots, which may have little or no matching relation. These shots or scenes may be long or short shots, or they may go from longshots to close-ups without any special transitions.

### BASIC EDITING PROCEDURES

Before we cover the basic procedures of editing videotape, keep in mind that the editing procedures and techniques in place at your NBS detachment may differ from what is portrayed in this section. For training purposes, let’s assume a script has been written and the primary narration has been recorded on the production tape. (This is a normal news/production requirement.) Atypical editing sequence might look like this:

1. The editor will work from a log that lists all of the scenes on the tape(s). It may be prepared at the time of the shooting or as the tape is being reviewed at the station or your office. The log will briefly describe the scene and indicate where it is located on the tape (using the counter on the playback VCR).

2. The producer, editor and sometimes the reporter will decide which scenes to use, the order in which to show the scenes and the amount of time you have to tell the story. In some instances (especially at small NBS detachments and aboard ships), one person will make all of these decisions.

3. The editor prepares a blank videocassette with countdown leader and enough control track to cover the length of the story. He then loads it into the edit/record VCR.

4. The raw video is loaded into the playback VCR. Now the editing process is ready to begin.

5. The story is assembled and edited according to the predetermined sequence. Sometimes the audio track is recorded first and the visuals added later. At other times, the sequences are assembled in order, depending on the type of story and available footage.

6. The editor labels the smooth tape with the title of the story, date and run time. A supervisor will review the story and make corrections (if necessary) before it airs.

The technical side of the editing process is fairly easy to learn. With today’s technology, the procedure is almost foolproof. Nevertheless, a good videotape editor must have a thorough knowledge of many related skills to provide viewers with a simple, yet effective, message.

### VIDEOTAPE SCRIPTING

*LEARNING OBJECTIVE: Identify the format of a script that accompanies a video news release.*

When you write a script to go with a video news release, make sure your pictures tell the story. The narration should supplement them, not overpower them.

**PUBLIC AFFAIRS OFFICE  
NAVAL AIR STATION SAMARA  
POINT KENT, FLORIDA 32505-5484**

**TELEPHONE: (904) 456-5070  
456-5071  
DSN: 922-5070  
FAX: 456-5072**

**FOR FURTHER INFORMATION, CONTACT:**

**LCDR LEE MAZZILLI (PAO)  
JO1(AW) JUAN AGUSTO (APAO)**

**OFFICIAL NEWS RELEASE  
(FOR TELEVISION)**

**PAGE 1 OF 1**

**RELEASE NO. 17-95**

**ARMED FORCES DAY**

**May 15, 1995**

**60 SECONDS**

**FOR IMMEDIATE RELEASE**

**VIDEO**

**AUDIO**

**NEWSCASTER:**

**NEWSCASTER:**

Armed Forces Day was celebrated today at Naval Air Station Samara, and the red carpet was rolled out for seven thousand visitors.

**SAILORS MARCHING  
(NAT SOUND)**

**(ON CUE)** Many guests arrived early **(NAT SOUND)** enough to see a contingent of sailors parade on Burnitz Field. They are recent graduates of Computer Repairman "A" School and will soon report to their assignments with ships of the fleet. Many spectators at today's parade have sons or daughters marching in the ranks.

**ADMIRAL ON STAND  
(NAT SOUND)**

**(ON CUE)** Rear Admiral Davey Jones, **(NAT SOUND)** the Vice Chief of Naval Education and Training, inspected the graduates as they paraded by the reviewing stand.

**EXHIBITS  
(NAT SOUND)**

**(ON CUE)** Visitors also saw special **(NAT SOUND)** exhibits showing the missions of the tenant commands at the air station. A panel of judges, made up of Samara residents, chose the most outstanding exhibit.

**MAYOR  
(NAT SOUND)**

**(ON CUE)** Mayor Jack Crevalle awarded **(NAT SOUND)** the top prize to Petty Officer First Class Kenneth Aidem, representing the air station's Crash and Salvage Division.

**###**

Figure 14-51.—Video news release

A video release (fig. 14-51) is similar in appearance to the radio news releases shown in Chapter 13 (administrative information, four-unit heading, release line, etc.), except you use two columns for the actual script. The left column is devoted completely to the video, or visual, section and the right column to the audio, or sound, section of the release.

Note that all of the information in the video column is in capital letters. This tells the news director that the information is there for information purposes only and is not to be read by the talent.

Below each video entry (except the first), in parentheses, is the phrase NAT SOUND. This tells the newscaster he will speak over the natural sound

recorded when the scene was shot. If there was no natural sound present, you will use “SIL” for silent.

At the beginning of paragraphs two through four in the audio column are the words *ON CUE*. This instructs the newscaster to look at the television monitor in the studio and wait for the scene described in the video column to appear before continuing.

In a standard video news release, lines average five words in length and are read at an average pace of 28 to 32 lines per minute.

## **TELEVISION PROGRAM MATERIALS**

*LEARNING OBJECTIVE: Identify the television program materials available from AFRTS-BC and the Navy Motion-Picture Service (NMPS).*

AFRTS-BC provides television news, information and entertainment programming for the exclusive use of AFRTS outlets, including all NBS detachments. It is the only source authorized to negotiate for, procure and distribute commercial and public broadcast programming.

AFRTS-BC acquires its programming at a minimal rate because of a special agreement with distributors, performers’ unions, guilds, music licensing organizations and industry regulatory agencies. Therefore, special handling procedures and use restrictions are required to ensure security of the videocassettes and prevent copyright violations. These regulations and restrictions protect the rights of the commercial broadcasting industry as guaranteed by the U.S. Civil Code.

This section is intended to acquaint you with the different program materials offered by AFRTS-BC. For more detailed information, consult *Armed Forces Radio and Television Service (AFRTS) Program Materials, DoD Directive 5120.20-R, Appendix F*.

### **TYPES OF AFRTS TELEVISION SHIPMENTS**

AFRTS currently circulates programs to outlets on videocassettes. Program packages are broken down into the following categories:

- Television weekly (TW)
- Television weekly “B” (TWB)

- Television weekly “C” (TWC)
- Television priority “A” (TPA)
- Television priority “B” (TPB)
- Television library (TL)
- Television temporary library (TTL)
- Television material (TM)

### **Television Weekly (TW)**

The Television Weekly (TW) is the largest package of television programs (approximately 80 hours) supplied weekly to full-service television outlets. This package features U.S. broadcast and cable network programs, preteen and preschool programs, talk shows, soap operas, quiz shows, movies, mini-series, information, religious and filler programming. Normally, one package is in use while two others are either at the outlet waiting to be used or en route. The TW package is circuited, meaning it is passed from one station to another along a predetermined “circuit” of several stations.

### **Television Weekly “B” (TWB)**

The Television Weekly “B” (TWB) is essentially the same as the TW package but does not contain the preteen and preschool programming. It is circuited to Super-SITE and SITE ships and contains approximately 72 hours of programming.

### **Television Weekly “C” (TWC)**

The Television Weekly “C” (TWC) is a scaled-down version of the TWB (roughly 42 hours of programming) and is circuited to smaller ships and submarines.

### **Television Priority “A” (TPA)**

The Television Priority “A” (TPA) contains about 12 hours of timely programming. It is not circuited but is sent directly to authorized outlets (primarily Navy ships) for use at the earliest possible date. If your detachment has access to SATNET (the worldwide AFRTS 24-hour satellite network), you will not receive the TPA package.

## Television Priority “B” (TPB)

The Television Priority “B” (TPB), while not currently in use, is reserved for possible future application.

## Television Library (TL)

The Television Library (TL) contains accountable library videocassettes shipped periodically to full-service, land-based outlets and fleet circuit managers for permanent retention. It is used to supplement normal programming or to fill emergency requirements.

## Television Temporary Library (TTL)

The Television Temporary Library (TTL) consists of accountable library videocassettes provided to meet special short-term requirements, such as holidays and anniversaries, or when AFRTS-BC requires that the materials be returned within one year. Return dates and instructions appearing on TTL packing lists must be strictly followed.

## Television Material (TM)

The Television Material (TM) contains nonaccountable library materials provided for single or repeated use and subsequent local disposal. Other usage conditions may exist and will be explained on the packing list.

## CUING AFRTS VIDEOCASSETTES

Most AFRTS videocassettes that are longer than 15 minutes contain AFRTS system cues at the end of the programs. The system cue is contained on a five-second segment that identifies AFRTS as the program source. It also alerts the control board operator that he must make a transition in five seconds.

Videocassettes 15 minutes in length or less do not contain system cues but are cue-dotted by AFRTS-BC. Cue-dotting is accomplished by inserting the proper series of cues electronically during videocassette editing. The “dots” are actually small white squares that appear in the upper right-hand corner of the television screen. Multiple videocassette programs are cue-dotted at 10, seven and two seconds from the end of each tape, except the last tape of the program. This tape will contain an AFRTS system cue instead of the cue dots.

## EDITING AFRTS TELEVISION MATERIALS

AFRTS television program materials are intended to be used as received. Outlets may not duplicate, edit or delete any part except in the following circumstances:

- To remove host-country sensitivities. (This must be done on a duplicate (dub) tape and not the original AFRTS-BC videocassette.)
- To air short excerpts for the promotion of upcoming programs (not to exceed two minutes).
- To remove commercials or commercial slugs, such as “Place Commercial Here” and “Splice Here.” If this happens, board-fade the unwanted section and cover it with an AFRTS or locally-produced spot. **NOTE:** Do not confuse commercials with sponsor or product mentions or identification, visual or aural, that are integrated into openings and closings in a way that makes their retention necessary for program continuity.
- To shorten the length of videocassettes specially designated by AFRTS-BC for future use.
- To repair damaged videocassettes.

Make sure you consult *Armed Forces Radio and Television Service (AFRTS) Program Materials, DoD Directive 5120.20-R, Appendix F*, for further details.

## HANDLING AFRTS VIDEOCASSETTES

Cleanliness is paramount when you handle AFRTS or any other types of videocassettes. Areas where television materials are stored or handled should be clean at all times and, if possible, ventilated with filtered air so that dust is blown out, rather than drawn in. AFRTS recommends that smoking, eating and drinking be prohibited in these areas.

Videocassettes must be kept in their shipping containers in a secure atmospherically controlled environment until they are ready for use and then returned immediately after use. This keeps the tapes clean and virtually eliminates the possibility of mixing programs with other videocassette shipments.

In general, the recommended storage conditions for videocassettes are a relative humidity of 50 to 60 percent and a temperature of between 60 and 80 degrees.

Do not leave videocassette containers open! An open container is an invitation to dust and debris. If you have a dirty container, remove the videocassettes and vacuum the container. When the container is clean, replace the videocassettes in the order specified on the packing list.

### **NAVY MOTION PICTURE SERVICE**

The Navy Motion Picture Service (NMPS) in Brooklyn, N.Y., provides most Navy ships with fret-run movies on Beta videocassettes. The tapes may be aired either at sea or in port. Eligibility for NMPS service is

based primarily on deployment duration, tape storage capability and security.

You may retain NMPS videocassettes for three or four years, depending on the lease agreement with the particular movie companies and NMPS. Lease expiration dates are indicated on each videocassette case and its accompanying synopsis card.

For further information about the NMPS Videocassette Program, refer to the *Navy Entertainment Movie Program Administration and Operations Manual*, NAVMILPERCOM 1710.1 series.



## CHAPTER 15

# RADIO AND TELEVISION INTERVIEWING

One of the most difficult tasks you will encounter as a Navy journalist is serving as a radio and television interviewer. In the space of a few minutes, an interviewer must draw out answers and reveal the attitudes of an interviewee that would normally take hours or even days of ordinary conversation. He must do it with various types of people, in front of cameras, under hot lights and in front of microphones.

As a broadcaster serving at an NBS detachment or aboard a SITE-equipped ship, you will conduct a wide variety of radio and television interviews. Your interview subjects maybe from within the command — for example, PN1(AW) Ellaverc, the command Sailor of the Year; Lt. Cmdr. Bilge, the newly reported chief engineer and former Miami Dolphins special teams player; or SA Maru, the mess cook who rescued a drowning youngster from a public swimming pool. Conversely, you may be asked to interview music and motion picture stars, politicians, community leaders and coaches of youth sports teams.

Regardless of the importance or prominence of the subject, you must not forget to take the following three actions to make every radio and television interview a success:

- Extract the facts
- Emphasize the important details
- Keep the audience informed

### TYPES OF INTERVIEWS

*LEARNING OBJECTIVE: Identify the most common types of radio and television interviews.*

With few exceptions, interviews for radio and television are generally in one of the following three categories which are covered in the succeeding text:

- Opinion
- Information
- Personality

### OPINION INTERVIEWS

While personal opinions may surface in other forms of interviewing, the thoughts or opinions (whether right or wrong) of the interviewee are in the spotlight in this type of interview.

The opinion interview is usually applied in broadcasting to support expanded news formats. A common form of this type of interview is the “man on the street” interview. The broadcaster stations himself in a busy public area and stops individuals to ask a question on a specific issue. Your station manager might send you out to ask for opinions or comments on a radical new fashion or fad, the completion of a commissary or base exchange, the outcome of a sporting event or countless other situations.

Commercial stations usually ask a question dealing with a highly controversial issue. However, policy dictates that NBS detachments and other military broadcast outlets refrain from posing questions that would adversely affect the morale of U.S. personnel or serve to undermine the commander’s authority. Check with your supervisor or the PAO if you plan to do this type of interview.

When you use the opinion interview, avoid the “stacked deck” method of gathering data — that is, do not seek comments from one particular group of people. Gather your responses from young and old, male and female and people of various ethnic backgrounds. This will give your completed program credibility.

In addition, do not ask a “loaded” question during an opinion interview. Note the following example:

**Example:** “Excuse me sir, don’t you think the new commissary is being constructed in an inaccessible location?”

Such a question leads the interviewee toward a particular response. In the preceding example, chances are very good the interviewee will respond with a yes answer. (Formulating interview questions will be covered later in this chapter.)

Before you conduct an opinion interview, prepare your questions in advance and make sure you research the topic thoroughly. The audience does not expect the

man on the street to be an expert, but it expects the interviewer to be thoroughly knowledgeable of the subject being discussed.

## **INFORMATION INTERVIEWS**

The information interview is the most common form of interview used at NBS detachments. The civilian broadcast equivalent is the public service interview. Your subject maybe the chief master-at-arms discussing local activities during Crime Prevention Week or the MWR director talking about what activities are planned at the recreation center. You might do an interview with a physician for a health series or the CO for your weekly captain's call.

Whatever the topic may be, your goal during the information interview is to inform the audience. You should research the topic and prepare your questions well in advance. You do not have to show your questions to the interviewee before the program, but it helps if you give your subject an idea of what you will ask This helps you keep your topic on track during the interview.

As a Navy broadcaster, you may be assigned to cover a wide range of adverse news situations. When you conduct an interview in conjunction with an accident or disaster, be sensitive to the feelings of others. Be careful how you phrase your questions and watch your tone of delivery. Use tact in finding out the five Ws and H and double-check your facts. If you need assistance in gathering the facts, consult your colleagues in the public affairs office.

## **PERSONALITY INTERVIEWS**

Another form of interview often assigned to Navy broadcasters is the personality interview. In this case, the person is important because of what happened to him, what he has done or the position he holds. It may be a timely feature story interview, a regular series or a celebrity interview.

During the personality interview, you must be versatile enough to make your delivery match the event. You must be sensitive to the situation and not antagonize the interviewee by making light of something he takes seriously.

Often, Navy broadcasters will be assigned to interview famous recording artists, motion picture stars or sports celebrities. Be aware that celebrities are accustomed to being interviewed and are well-seasoned at this art. If you are not careful, the celebrity you are interviewing may try to run the show.

Again, the key to producing a good personality interview is research. Read every available newspaper or magazine article on your subject. Know about his past, his rise to success, what he is doing now and his plans for the future. Write intelligent and stimulating questions. Personality subjects appreciate new material and grow weary of answering the same questions time and time again.

## **INTERVIEW METHODS**

*LEARNING OBJECTIVE: Recognize the most common interview methods.*

What method should you use to conduct an interview? The answer depends on the subject, time, place and other intangibles that make each interview different.

In most circumstances, you will use one of the following three interview methods to get the required information for your program:

- Scripted
- Semi-scripted
- Ad-lib

### **SCRIPTED**

In the scripted interview, all the questions and answers are prepared in advance and the interviewee(s) simply read(s) the prepared text.

While certain high-ranking officers and officials involved in sensitive or security areas may prefer this method, the scripted interview must not sound like it is being read. If it does, then the program becomes stilted and the conversational aspect of the interview is lost. Likewise, listeners or viewers will lose interest and tune out the message you are trying to deliver.

Unless security or policy concerns dictate the use of the scripted interview, you should avoid it.

### **SEMI-SCRIPTED**

The semi-scripted interview method is the best for most interviews. With this interview, the interviewer researches the subject and interviewee, discusses possible questions in advance and perhaps even rehearses the interview. This method provides an excellent balance between the ad-lib (covered next) and the fully scripted methods and is personal, yet focused.



## **AD-LIB**

While all interviews should be conversational, the ad-lib method can carry this to the extreme. The unprepared atmosphere of the “just sit down and start talking” method can cause stuttering, repeated questions or answers, off-the-subject discussions, long pauses and security or propriety violations. For these reasons, you must be focused when you use the ad-lib interview method.

Areas where the ad-lib method can be used include occasions of spontaneous news, such as on-the-scene reports and other “live” topics of interest.

### **INTERVIEW FORMAT**

*LEARNING OBJECTIVE: Recognize the areas that comprise the format of an interview.*

Now that you know the different types of interviews and the methods with which to conduct them, we will examine the standard interview format. Simply stated, all interviews have the following three parts:

- The opening
- The body
- The closing

### **THE OPENING**

The opening clearly identifies you, your subject and the topic. This allows your audience to know “up front” whether the interview has any direct interest to them. Additionally, the opening can give your location to establish a local tie-in or explain any background noises.

### **THE BODY**

The body is the interview itself — the actual questions and answers. At this point, the interview takes shape and becomes a reality.

### **THE CLOSING**

The closing is an abbreviated form of the opening. During the closing, you can summarize briefly the content of the interview and once again identify yourself and your guest.

The opening and closing may be the most important parts of the program, since the opening grabs the

audience’s attention and the closing provides a conclusion to the story being told.

After you have determined the focus of the interview and formulated your questions, you may write and record the opening and closing before you talk to your guest (if time permits). If you want ambient (natural) sounds for the opening and closing of a radio interview, take your script along and read it at the interview site. For television, memorize those parts you will do on camera. Of course, if you need additional information that you will gather during the interview, you can record the opening and closing afterward.

Keep in mind that you may deviate from this interview format. Be creative with visuals or audio and vary the wording of the opening and closing so your audience is not barraged with “carbon copy” interviews.

### **LIVE AND TAPED INTERVIEWS**

*LEARNING OBJECTIVE: Identify the types of live and taped radio and television interviews.*

Only under the most extraordinary conditions will you conduct a live television interview; therefore, we will not cover it in this section. However, when you plan a radio interview, you should consider whether you want to present it live or on tape and address the concerns of taped television interviews. Both the live and taped interview methods are covered next.

### **LIVE INTERVIEWS**

Live interviews, especially opinion interviews, are difficult to control from both a propriety and sensitivity aspect. However, there are several ways you can conduct live interviews on radio. They are as follows:

- Studio
- Remote
- Telephone

#### **Studio**

The studio interview is usually either a personality or informative interview. Make sure you have enough microphones in the studio for all interview participants. Although a common setting for a live radio interview, the studio interview tends to present a sterile atmosphere. Additionally, a strange location may intimidate the guest, preventing him from really “opening up.”

## Remote

The remote interview is either the informative, personality or “man on the street” type of interview and it is often conducted at a specific event. The major disadvantages of a remote interview are the limitations in station equipment and the lack of control over the environment. Nevertheless, this type of interview gives you the advantage of timeliness.

## Telephone

The telephone interview can be either an opinion, an informative or personality interview. Good audio levels are sometimes hard to get during a telephone interview, so make sure you consult your engineer before airing the interview live. Furthermore, make sure you inform the interviewee of your intentions before you air the discussion live.

## TAPED INTERVIEWS

The taped or “canned” interview is the preferred method of presenting a radio or television interview. Although it usually lacks action, presence and spontaneity, the taped interview gives you total control of timing, format and content and it allows you to choose the means or location to bring out the best in your guest and subject.

When you tape an interview from a remote site, make sure the background noise enhances the interview, rather than disrupt it. Your knowledge of the directional capabilities of microphones and selecting the correct one will help you in this area.

You can respond quickly to news events by taping interviews over the telephone. Use only portions of the interview as news inserts or actualities because the audio quality is generally poor and would become distracting over a long period. If your questions are to be used as part of the interview or actuality, make sure the audio levels are balanced.

You may have no choice as to whether you do a television interview in the studio or as a remote. If you do have a choice, the studio is preferred for a self-contained interview program. The studio provides a controlled environment. The sets are ready, shots and camera movements are planned, audio is checked well in advance and the crew is prepared long before the interview begins. As you learned in Chapter 14, the set determines the tone of the interview. Viewers form their first impression from the set. It should complement the interview and not compete for the viewers’ attention.

Many of the radio or television interviews you do will not be in a studio. By recording an interview on location, you add excitement, realism and a sense of being there. Often an interview subject is much more comfortable in his own office or surroundings — rather than in a studio — and this usually leads to a better interview.

Before you tape a remote interview (if time permits), survey the location to avoid problems. Your primary consideration should be checking the acoustics and deciding if ambient noise will be distracting. The use of background noise can enhance the interview if it is unobtrusive and blended at a level that does not overpower the conversation. Remember that your equipment may record noise you are not aware of from air conditioning or other electronic equipment. Identify an alternate location if you think you will encounter problems.

## INTERVIEW PREPARATION

*LEARNING OBJECTIVE: Identify the preparatory considerations of radio and television interviews.*

The preparation considerations for radio and television interviews are similar. Whether you are assigned an interview or tasked to develop the program yourself, thorough planning is essential.

In this section, we cover the following four basic interview planning steps:

- Arranging the interview
- Researching the subject
- Formulating questions
- Arranging transportation

## ARRANGING THE INTERVIEW

Before you arrange an interview, make sure the potential interviewee is an expert on the subject. Just because Ens. Isobar works in the weather office does not mean she knows the most about hurricanes and tornadoes.

Once you know who you want to interview, call that person and identify yourself by name, rank and office. Tell him what subject(s) you want to cover and suggest a time, date and location.

End the conversation by recapping the arrangements agreed upon. If the interview is more than a day away, contact him a few hours in advance to confirm the arrangements.

## RESEARCHING THE SUBJECT

By this time, you should know the important role research plays in interviewing. Your audience expects you to be knowledgeable and the interviewee expects you to know about him or the topic of the interview. The more you know, the better will be your questions. In fact, it is a good idea for you to go into an interview knowing all the answers to the questions you will ask

The following are some tips to help you research your subject:

- Check with the appropriate public affairs office for a biography or fact sheet if the story involves military equipment, a distinguished visitor or key officer. Also look for guidance regarding topics that might be sensitive in nature.
- Gather useful background materials at the library (magazine or newspaper articles, encyclopedias, reference books, technical manuals, etc.).
- Know where and how to find the point of contact for the subject.
- Seek local expertise at the appropriate agency and talk to these people about the subject or topic of your interview. (This adds depth and background to the program.)

Let your research material guide the interview, not control it. While conducting the interview, remember that you represent the audience who does not have the facts you have.

## FORMULATING QUESTIONS

The key to a good interview is your asking clear, concise questions. Determine the focus of your interview and formulate your questions around a primary idea. Be prepared to leave yourself open to new information you may not have known. You might have to switch your focus or incorporate new information into your final product.

Different types of interviews have unique approaches with varying question types. The length of time you have also determines the questions you can ask. If you have ample time, you can discuss the topic

at length. On the other hand, if time is at a premium, word your questions to get to the point quickly.

Keep the following suggestions in mind when you formulate your interview questions:

- Ask open-ended questions — questions that cannot be answered with only a “yes” or “no” reply. For example, if you are interviewing the head coach of a football team, you would ask “Describe your team’s attitude for today’s game,” instead of, “Is your team up for today’s game?” If you must ask a question that is answered by yes or no, ask the interviewee to explain his answers in more detail. Further, by using the five Ws and H as the first word in your question, you assure yourself of more than a yes or no reply.
- Be simple and direct. Do not beat around the bush in asking a question or by asking multiple questions. This only confuses the interviewee and your audience.
- “Off-the-record” conversations are exactly that — off-the-record. Do not ask questions previously discussed in confidence during the interview.
- Avoid asking trite questions. For example: “Today our guest is Senator Spike Moss, Republican from Hawaii. How are you today?”
- Do not ask your guest embarrassing or antagonistic questions. For example: “Coach, you gave your catcher the steal sign with two outs and your team down by seven runs. He was thrown out easily at second base. This violates a basic baseball strategy even a 5-year-old would understand. Why did you do it?”
- Avoid using military jargon. If you must use jargon or acronyms, explain them. Do not assume your audience knows the topic as well as you and the interviewee know it.
- Do not comment on responses in trite ways or act surprised. For example: “I agree” or “You don’t say!”
- Use questions that will interest your audience. Ask yourself what it is they would like to know from the subject.
- Prepare more questions than you think you will need. This will ensure the best possible coverage of the topic.

## ARRANGING TRANSPORTATION

“You can’t get there from here.” That is exactly what will happen if you do not plan your transportation requirements early. The availability of transportation varies from command to command. Regardless of whether your unit has its own vehicle or you rely on a motor pool, advance coordination is necessary. In some cases, the organization you are assigned to cover may provide transportation. However, you should not depend on it. Getting to the interview site is your responsibility.

## EQUIPMENT CONSIDERATIONS

*LEARNING OBJECTIVE: Identify the equipment considerations that apply to radio and television interviews.*

You must pay particular attention to the technical aspects of interviews, especially those for television. As you discovered in Chapter 14, any television production is a complex team operation, which means a lot of planning will go into the interview.

## TELEVISION

As the talent of a studio interview for television, your involvement with the actual setup procedures (lights, cameras, etc.) will be limited. You must remain focused on the task at hand — preparing for the interview.

The opposite is true when you shoot interviews at remote locations. You will be accompanied by another member of the ENG team, and between the two of you, you must handle the duties on both sides of the camera.

The following is a checklist you can use to prepare for a television interview at a remote location:

- Check your equipment cables to make sure you have the right ones and they are all working.
- Check all batteries the day before the interview. If they are not sufficiently charged, you can charge them overnight.
- Pack a sufficient amount of videocassettes and make sure they are either new or bulk erased.
- Check the condition of the camera and the camera lens.

- Run a test with the camera, recorder and microphones to make sure each component functions properly.
- Inventory all of your gear — the camera viewfinder, cables, microphones, spare batteries, spare videocassettes, headsets, lighting gear and other necessary equipment.
- Run a test of the lighting kit to make sure it works properly.
- Check your transport cases and containers to make sure they are available and are in good condition with working latches.

## RADIO

Use the following checklist to help you prepare for a radio interview:

- Check the record and playback functions on your reel-to-reel or cassette tape recorder. Make sure you are recording at the right speed. If necessary, clean the heads or have it done by an engineer.
- Make sure the microphones are working and check the quality of the audio. You may have state-of-the-art equipment and the best technical crew around, but it is best for you not to leave anything to chance.
- If batteries are used to power the recorder or operate the microphone, make sure they are fresh and take along spares.
- If you plan to use AC current, make sure there is an electrical outlet close to the interview location and that the power cord will reach.
- Spot-check the playback after the interview to be sure you have something on tape, but do not give the interviewee the opportunity for a retake.

## HELPFUL INTERVIEW HINTS

*LEARNING OBJECTIVE: Recognize the helpful hints used in radio and television interviews.*

You have selected the interview method and format, arranged the interview, researched the subject, formulated the questions, arranged transportation and checked your equipment. Everything is on track and pointing toward a successful interview. What else should you do?

Although not an all-inclusive list, the following helpful hints will make the difference between a good interview and a great interview.

## **BE PROMPT**

Nothing is more exasperating than an interviewer who has little concern for timing. You should arrive at the interview site well before the scheduled time to set up the lights, camera and the recording equipment. When you are late for an interview, your subject may be less cooperative than he might have been, and in some cases, it may mean less time for you to ask all those important questions.

## **MAKE YOUR SUBJECT FEEL COMFORTABLE**

If this is your subject's first interview, he will probably be nervous. Some common signs of nervousness include the following behaviors:

- Tapping one's pencil or fingers on the desk
- Infrequent or nonexistent eye contact
- Pulling away from the microphone
- Excessive stuttering or stammering
- Very short answers to your questions
- Frequent interruptions of your questions

Sometimes you can make your subject feel more comfortable by talking about other things, and therefore, take his mind off the interview. You can do this during a spot break for live interviews or at a logical stopping point for taped interviews. Furthermore, since everyone has a sense of personal space or a "comfort zone," you should select a seating arrangement that your guest finds comfortable. One caveat to this strategy is that you should not compromise the quality of the finished product in favor of comfort. Explaining your technical requirements to the interviewee will help.

## **BE ATTENTIVE**

The most important characteristic of a good interviewer is being a good listener. Your subject will be more cooperative if he perceives that you are interested in what he has to say. Good eye contact and your making the appropriate responses at the right time will show the interviewee that you are paying attention and want to know more about the subject.

Always listen to what your subject is saying. Some interviewers are more concerned about what they are going to ask, rather than what the subject is saying — **stay clear of this trap.** Interviewees occasionally answer the question you are about to ask, so be alert and adjust your questioning strategy accordingly.

By being an active listener and asking the appropriate questions, you can keep your interview on track and get the information you need in as short a time as possible. However, if you receive obscure, contradictory or confusing answers to your questions, ask follow-up questions to clarify the point. If the interviewee strays in his answer to a question, rephrase or repeat the question to get him back on track

When you listen attentively, you also may pick up on a fact you did not know about and slip in effective follow-up questions.

Visualize the editing process while you are recording the interview. If your subject tends to ramble when answering questions, pay close attention to the responses to know when the question is answered, and therefore, when you can edit.

## **APPEARANCE**

Your personal appearance is always important, whether in your day-to-day duties or when you conduct interviews for radio and television. Any violation of Navy uniform regulations, grooming standards or body fat guidelines is particularly obvious on camera and will be noticed by hundreds (or possibly thousands) of people. Your appearance can enhance your credibility or detract from it, so check your appearance thoroughly before the interview.

## **POST PRODUCTION**

*LEARNING OBJECTIVE: Identify the procedures used to wrap up radio and television interviews.*

Once you have completed talking to the interviewee and you are back at your studio or office, immediately review the interview tape while it is still fresh in your mind. The following tips will help you put together your program or story with better efficiency:

- Make a run sheet for your radio interview listing questions, answers and good edit locations. Before you preview the footage for your television interview, reset the tape counter to zero, then log each scene on a shot sheet by

number in the order it appears on the tape. Check for acceptable audio, video and picture composition.

- Be certain your topic does not violate security or the policies stated in *PA Regs*. Your interview must not be libelous, violate host country sensitivities (if you are assigned overseas) or breach an individual's privacy.
- Make sure audio levels match at edit points.
- Protect the credibility of the interviewee. Since it is possible for you to delete, add or rearrange

words, sounds, sentences and entire paragraphs while editing the interview, be especially careful not to change the meaning of what the interviewee has said.

- Make a final check of the finished product before you give it to your supervisor. Examine the content. Does the interview tell the story? Are the questions answered? Is it concise and interesting? Is it factual? Check the technical quality of the final product for clean edits and good audio or video.

## CHAPTER 16

# PUBLIC AFFAIRS OFFICE OPERATIONS

The previous 15 chapters of this TRAMAN covered the three primary functional areas of the Journalist rating — print journalism, photography and electronic journalism (radio and television). The fourth area, public affairs office operations, is considered a separate entity by many in the rating, yet it often incorporates elements commonly found in the other divisions. For instance, when you prepare a command presentation (explained later), you apply the same knowledge used to write a video news release (covered in Chapter 14).

As a junior journalist, your first public affairs experience will be aboard ship (aircraft carrier, destroyer tender, etc. or at a large shore command. You should be aware that no two public affairs offices are organized the same way, because every command has a different mission, size and public affairs objective. However, most large public affairs offices are divided into the following departments: internal information, media relations, community relations and administration. Figure 16-1 shows a typical public affairs office organization chart.

As you learned in Chapter 1, you may work for a collateral-duty PAO (an officer who has other assignments that are considered primary duties). In this situation, the public affairs office “staff” may consist of you and perhaps a YN3 or civilian secretary. Conversely, a larger public affairs office ashore may have a full-time 1650 PAO (usually a commander or a captain), a JOC or above as LCPO, a JO1 or JO2 as LPO, and a combination of JO3s and JOSNs. There also may be one or two civilian assistants to the PAO handling everything from secretarial duties to media embarks and community relations.

Regardless of the manning situation in place at your command, you soon will realize that every public affairs office brims constantly with activity. Your versatility will be stretched to its maximum potential as you handle a myriad of tasks, including (but not limited to) the following:

- Drafting naval letters
- Maintaining office files

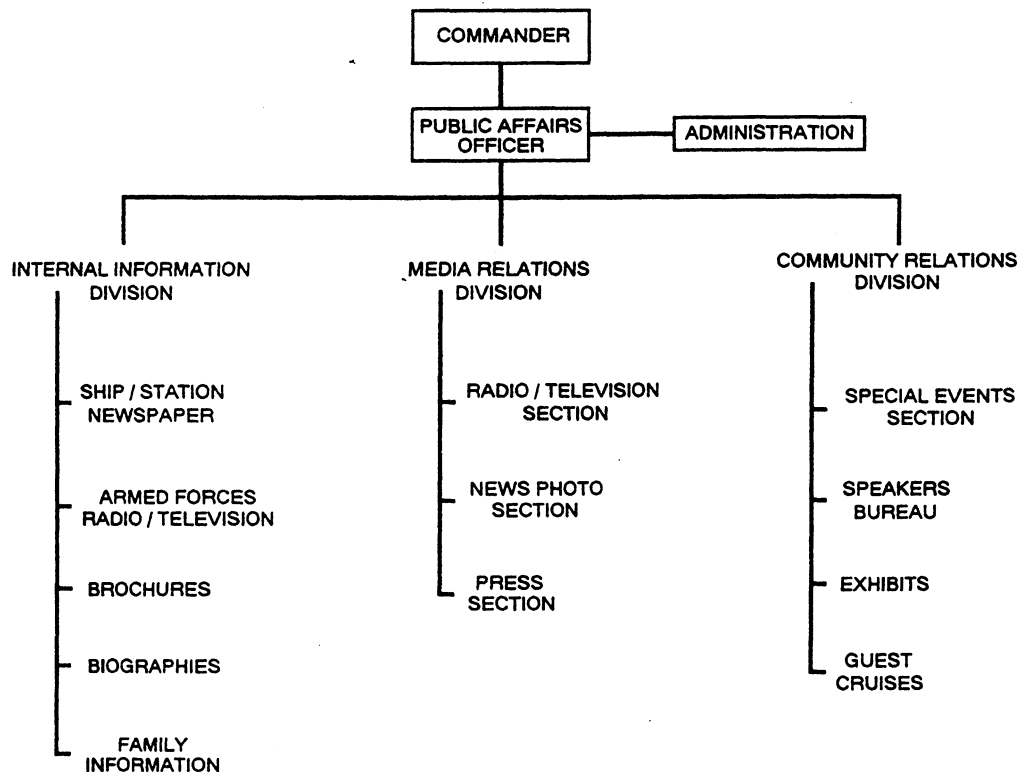

Figure 16-1.—Public affairs office organizational chart (large).



1  
2  
3  
4  
—

\*DEPARTMENT OF THE NAVY  
\*Name of Activity  
\*Address

1  
2

SSIC  
Code/\*Serial  
\*Date

1  
2 From: Title of activity head, name of activity, location when needed  
To: Title of activity head, name of activity, location when needed (Code)  
Via: (1) Title of activity head, name of activity, location when needed (not numbered if only one)  
(2) Pattern of (1) repeated for next endorser

1  
2 Subj: NORMAL WORD ORDER, ALL LETTERS CAPITALIZED

1  
2 Ref: (a) Earlier communication that bears directly on subject at hand

1  
2 Encl: (1) Material enclosed with letter identified in same way as reference, single enclosure numbered  
(2) Notation added for material sent separately (sep cover)

1  
2 1. This example shows all the elements that might appear on the original of a one-page standard letter.  
2. If you omit the date when you type the letter, start the From block on the fourth line below the code/serial to allow for an oversized date stamp.

1  
2  
3  
4  
—

\*NAME OF SIGNER  
\*By direction

1  
2 Copy to:  
Short title of information addressee (see SNDL)  
Short title of second information addressee

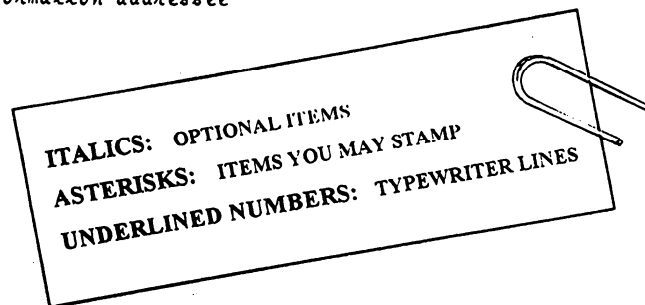

Figure 16-2.—Standard naval letter.

- Preparing command welcome information
- Writing the command history
- Writing the command presentation
- Writing command/flag officer biographies
- Escorting members of the media
- Conducting tours
- Maintaining and inventorying public affairs office equipment

Do not let this list intimidate you. When you combine the knowledge you have gained from reading this TRAMAN with plenty of hands-on experience and office training, you will be successful in your public affairs office endeavors.

### THE NAVAL LETTER

*LEARNING OBJECTIVE: Identify the components of a standard naval letter.*





DEPARTMENT OF THE NAVY  
 USS CUSHING (DD 985)  
 FPO SAN FRANCISCO, CA 96662

1  
 2  
 5216  
 Ser DD 985/28  
 January 5, 199\_

1  
 2  
 Coover Precision, Inc.  
 Attn: E. Jones  
 6923 W. Hobson Blvd.  
 New York, NY 11378

1  
 2  
 Gentlemen:

1  
 2  
 When writing to a company in general but directing your letter to a particular person or office, use an attention line between the company's name and its address. Type Attn: and then a name or title.

Make the salutation agree with the first line of the address. If the first line is a company name, the salutation is Gentlemen even if the attention line directs the letter to an individual. Note the inside address and salutation in this letter.

1  
 2  
 1  
 2  
 3  
 4

Sincerely,

G. E. JENKINS  
 Commander, U.S. Navy  
 Executive Officer  
 By direction of  
 the Commanding Officer

1  
 2  
 Encl:  
 (1) Correspondence Manual (sep cover)

Figure 16-3.—Business letter.

One of the most important tasks you will perform in the public affairs office is drafting the naval letter. Whether responding to “fan mail” (a request for a welcome aboard booklet, photographs, etc.) or a media query, your letters must be letter-perfect and grammatically correct.

**STANDARD NAVAL LETTER**

The format of a standard naval letter is shown in figure 16-2. As you can see, it does not contain a salutation or complimentary close, because it is used to communicate with other naval commands and agencies within the DoD. All margins and space between headings and paragraphs are standardized. Punctuation is used as sparingly as possible.

The body of a naval letter contains the substance or essential facts of the communication in simple, concise,

impersonal and tactful language with no repetition. Each paragraph should express one complete thought in logical sequence. If tables, diagrams or sketches are needed to add clarity to the letter, you may include them as separate enclosures. When you draft a letter in reply to another letter, make sure you answer all questions—whether expressed or implied by the writer.

Use tact when you draft a letter for the superior of the person who will sign it (for example, a letter from your CO to the admiral). In this situation, the skipper will invite attention to a special matter; he will not direct attention to it.

**BUSINESS LETTER**

The business letter (fig. 16-3) is used to correspond with agencies or individuals outside the DON or DoD who are unfamiliar with the standard naval letter. It may

be used for correspondence between individuals within the Navy when the occasion calls for a personal approach.

Whether you are preparing a standard naval letter or a business letter, always double-space the rough draft to allow for corrections and other notations.

More detailed information on naval letters and other types of correspondence may be found in the Yeoman 3 TRAMAN and in the *Navy Correspondence Manual*, SECNAVINST 5216.5 series.

## ADMINISTRATIVE AREAS

*LEARNING OBJECTIVE: Identify the main administrative areas in a public affairs office.*

Now that you know the basic formats of the two most common naval letters, we will take a look at the main administrative areas of a public affairs office.

### FILES

The success of any file system can be measured by your ability to file material correctly so that anyone in the office can locate it promptly. Further, your files must be kept current and not allowed to age in the in-basket on your desk.

The amount and variety of files maintained in your office depend largely on the mission of the command and the tasks handled by your office. Since information is often needed without warning and without delay, an incomplete file or one without a logical filing order may be as useless as none at all. Your filing system must be uniform and every member of the public affairs office staff should be acquainted with it.

You should maintain the following types of files in both small and large public affairs offices:

- Command file
- Media relations file
- Community relations file
- Project file
- Speech file
- Future file
- Matters pending file
- Correspondence and memos file

- Alibi file
- Clip file
- Photographic file
- News release file
- Fleet Home Town News Program file

### Command File

The command file contains reference material concerning the command, including the command history and statistics; biographies of the CO, XO, C/MC and other senior people of the command; and records of change of command ceremonies. These materials are used primarily for inclusion in welcome aboard booklets and media information kits. Additionally, you should devote a separate portion of the command file to any appropriate historical documents, such as previous command awards or old newspaper clippings.

### Media Relations File

The media relations file contains a listing of all media in the local area, including the names, addresses and telephone/facsimile numbers of military beat reporters and news directors. It also includes information regarding deadlines, broadcast times and special requirements for copy and photographs. Some commands subdivide their media listing to reflect local commercial media and local military media.

### Community Relations File

The community relations file exists to help PAOs plan effective community relations programs. It contains the names, addresses and telephone numbers of civic leaders and community groups with which the command maintains contact. The community relations file also should contain a study of the community and pertinent facts.

### Project File

The project file contains past, present and future public affairs projects involving the command. It concerns such special events as general public visitations, military parades and ceremonies, holiday observances and dependents' cruises. This file also contains the planning information (letters, memos, and miscellaneous notes) that pertains to each project. You can use information in this file as reference material when a similar event is scheduled at a later date.

## **Speech File**

The speech file contains copies of all prepared speeches and other presentations delivered by members of the command in connection with the speakers bureau. It also contains background material for future speeches, such as the *Navy Fact File* (NAVSO P-3002) and *Navy Talking Points*, a collection of authoritative information on important Navy issues.

## **Future File**

The future file contains a current listing of all events that have been scheduled or planned for the future, such as a general public visitation, change of command or VIP visit.

## **Matters Pending File**

The matters pending file contains notes and reminders on pending ideas that maybe useful for news releases, feature stories, news pegs for special events and other public affairs activities. This file also contains reminders on matters to be discussed at staff meetings, conferences and consultations with the CO or XO.

## **Correspondence and Memos File**

In many commands, all official correspondence is filed centrally in the administration office. However, some commands operate a decentralized filing system with each department or office taking responsibility for correspondence under its cognizance. Regardless of where your public affairs correspondence is filed, you should become familiar with the filing system. If you need a letter or a memo from five months ago, you should know where to find it — the actual location of the files is inconsequential.

Keep two copies of all outgoing correspondence originated by your office and signed by the PAO — file one in the master outgoing correspondence file and the other in the related subject or project file. If the correspondence originates at your office, but is signed by the CO or another officer “by direction,” maintain one copy in the appropriate file.

Incoming correspondence that directly affects a current or future project should be filed in the public affairs office. Make a copy of all incoming correspondence dealing with public affairs. If your files are complete, you will encounter fewer problems later on.

In addition to filing correspondence properly, keep in mind that correspondence routing and control also are very important. Incoming correspondence and other paperwork first goes to the PAO, who then routes it to the appropriate staff member. If correspondence is routed to you for action, make sure you follow through on it without being reminded. If it is routed to you for information purposes only, keep it moving. Do not let correspondence gather dust in your incoming basket!

If you pickup incoming correspondence from the administration office or the mail room, attach a routing slip to each individual letter/memo and place it in the PAO’s or senior journalist’s incoming basket as soon as possible.

## **Alibi File**

The alibi file contains copies of news advisories released to the news media. A news advisory is a shortened form of a news release intended to get the news media to cover an event themselves. This file also contains query sheets that document the oral release of information. News media queries are covered later in this chapter.

If the PAO is questioned about a news advisory or a query sheet, he can use the alibi file to justify the action taken.

Although a separate file, the news release file (covered later in this section) is another type of alibi file.

## **Clip File**

The clip file contains clippings of stories that have been released and have appeared in print. Normally, the public affairs office has subscriptions to all local printed media to which material is frequently released. One of your first tasks each morning might be to screen and clip the daily papers for articles about your command or the Navy. PAOs and senior journalists use these clips to evaluate the effectiveness of public affairs programs and to plan new ones. In addition, they can determine easily how many news releases are being used in a week, month or year.

Make sure each clip is cut from the source as straight as possible, and center mount it on an 8 1/2-by 11-inch sheet of plain bond paper using a paper adhesive, preferably rubber cement. Stapling or taping the clip to the backing sheet will not give you a professional product.



**Figure 16-4.—Three-quarter aerial bow photograph of USS *Mobile Bay* (CG 53) underway.**

In either the upper left or upper right-hand corner of the clip sheet, type the following information: (1) name of the publication, (2) date of the publication and (3) the page number in which the clip appeared. Make a notation if the clip extended over more than one page.

### **Photographic File**

Good photographs are always in demand. If you are attached to a ship, you should stock 8- by 10-inch photographs of the ship underway, such as the three-quarter aerial bow photograph shown in figure 16-4. At a shore command, you should have 8-by 10-inch photographs of several points of interest.

Aircraft squadron PAOs usually have on hand photographs of its planes in flight (fig. 16-5) along with

general scenes of squadron structures, such as hangars and other points of interest.

In addition to photographs of hardware, you should carry photographs to accompany the biographies in the command file. Usually 4- by 5-inch black-and-white head and shoulders shots will satisfy the needs of most news media. However, you will need 8- by 10-inch black-and-white and color photographs for magazines and media kits.

Make sure the photographs are current. If your CO advances from commander to captain, you must have several copies of the new photograph on file.

Every public affairs office accumulates several miscellaneous photographs. If you think the photographs can be used at some point in the future, create



**Figure 16-5.—Aerial photograph of an EA-6B Prowler over the Olympic Mountains.**

files for them. When you file photographs, file them under general subject headings, such as “Carrier Operations,” “Sports” and “Sea Evolutions.”

You cannot maintain a good photographic file without the support of your command imaging facility. Make sure you build a good working relationship with the photographer’s mates or their civilian counterparts.

### **News Release File**

Your news release file should contain the original news releases distributed to the media. As you learned in Chapter 7, a release number is normally assigned to all outgoing stories — for example, the first release of 1995 would be 1-95, the second would be 2-95, and so forth. Start a new news release file at the beginning of each year and file the most current release on top.

### **Fleet Home Town News Program File**

You should maintain a 90-day log book or index file of each release form mailed to the Fleet Home Town News Center (FHTNC). In addition, we recommend that you copy and file every release form that is part of a hold

file. The Fleet HomeTown News Program and the FHTNC will be covered in Chapter 17.

### **Filing Tips**

To help maintain your files properly, consider practicing the following tips:

- Label your file drawers neatly so its contents can be identified quickly.
- Give your files room to breath. Do not cram news releases, photographs, and so on, into files and risk irreparable damage.
- File material in the proper folders.
- File papers facing forward in chronological order, with the latest date on top.
- Use standard file fasteners, rather than staples, to bind papers.
- File papers so the edges do not protrude beyond the edge of the folder.



**USS GERMANTOWN (LSD-42)**

---

**WELCOME  
ABOARD!**

**United**

**States**

**Ship**

**GERMANTOWN (LSD-42)**

---



Figure 16-6.—Welcome aboard booklet.

## COMMAND WELCOME INFORMATION

Your command welcome information is normally in the form of a welcome aboard booklet (fig. 16-6). The booklet familiarizes visitors and guests with your ship or station and usually contains the following items:

- A photograph of the ship (for shore stations, a photograph of the main gate or other familiar point of interest)
- A welcome letter from the CO
- A mission statement
- A brief history of the command
- A list of unclassified statistics and facts

The format of a welcome aboard booklet varies from a single-sheet trifold to an eight-page layout. Most editors of welcome aboard booklets use 60-pound cover stock for the front and back covers and either a four-or eight-page layout (saddle-stitched). Your particular design will be determined by the available funding and the amount of information you have.

If your ship is scheduled to deploy, you may have your welcome aboard booklet translated into several different languages. For further information, write to the Commanding Officer, Naval Technical Intelligence Center (NTIC DS32), 4600 Silver Hill Road, Washington, DC 20389.

## COMMAND PRESENTATION

The command presentation often makes the first and most lasting impression on your visitors. You can deliver it in a command conference room or at a civilian auditorium or banquet room during a community speaking engagement.

Most command presentations are narrated live from a script and accompanied by either overhead transparencies or 35mm slides. Some are recorded on videotape and have the same characteristics as a video feature story. The latter is the most polished of the three presentation methods, but it is not always the most prudent choice. Updating a command presentation on videotape takes time and it may not be suitable for viewing by large audiences. Transparencies and slides are relatively easy to work with and make a very flexible command presentation.

### Planning

Before you begin work on a command presentation, ask yourself the following questions:

1. What is the objective of the presentation? (Increase community awareness about the command?)

Tell how the command contributes to national defense? Familiarize newly reporting personnel?)

2. What is the target audience? (VIPs? Active-duty military members? Local residents?)

3. What format should I use?

4. What resources are available?

Answering these questions in advance will let you determine how technical you can get, what to emphasize and how to arrange the information.

### Organizing

A typical command presentation begins with a description of the unit, its overall mission and brief history. It then progresses quickly to the present tense and describes what the unit does and how it does it (in detail). The way your command is organized provides a logical outline for the order of your command presentation. Start at the top and work down, illustrating your script with visuals. Try to avoid too many images of static objects. People actually doing their jobs will stimulate interest and tell the story most effectively.

### Scripting

When you formulate your command presentation, write the words to the script first, then locate or create the images to support it. Keep the narration short — between three and 10 seconds for each visual.

The script for a command presentation is similar in appearance to the video news release shown in Chapter 14, save the administrative information, four-unit heading, release line, and so forth. Use the left column to identify the visuals and the right column for the narration.

Some other points for you to consider regarding command presentations are as follows:

- Keep charts and graphs simple.
- Limit the number of “word” transparencies/slides.
- Keep the format and color of title and “word” slides consistent.
- Make sure the type in “word” slides is large enough to be read easily.
- Keep the sentences in the script short and use the active voice.
- Avoid mixing vertical and horizontal slides in the same command presentation.
- Avoid using Navy acronyms.

- Make sure your presentation is between 15 or 20 minutes in length. The longer the presentation, the more you risk losing your audience.

Further information on staging a presentation can be found in Chapter 6 of the *JO 1 & C TRAMAN*.

## COMMAND HISTORIES

Command histories provide the **only** overall account of the activities and achievements of U.S. Navy commands. Housed at the Naval Historical Center in Washington, D.C., command histories serve as the eventual basis for published naval histories.

All command histories are indexed and accessible to authorized users (within security limitations). They are used by staff officers who need information on the recent past, as well as by official study groups, authorities responsible for verifying unit combat and overseas awards and service, and often the command itself when a need arises for background information. Furthermore, numerous queries from other government officials, Congress, former naval members and the public at large are answered using command histories.

Normally the PAO is tasked by the CO or XO to write a complete annual history of the command. However, this assignment may someday be your responsibility, especially if you work for a collateral-duty PAO.

The typical command history is not intended to be a work of literary art, but you must write it in clear and concise English with a minimal amount of technical jargon and acronyms. It should contain a basic historical narrative written in chronological order or broken down by department or subject. It also should include significant statistical data that should be part of the Navy's permanent records, such as ammunition expenditure, number of underway replenishments, ships and aircraft overhauled and repaired, and other facts important to fulfill the mission.

Follow the narrative with a brief discussion of any special topics that merit further coverage, such as major events, developments and operations; changes in missions and functions since the submission of the last command history; and changes (if any) in home port, group, squadron or headquarters. Include any appropriate supporting documents, such as change of command booklets, "personal-for" messages and biographies.

Some references you can use to compile the command history include deck and engineering logs and the ship's diary. You also may ask each department head to submit a monthly input (if not already ordered by the CO or XO). Another method is for you to maintain an

annual file and put notices, memos and ideas in it. Use whatever method works for you, but make sure you gather the material you need well in advance to meet the submission deadline. With few exceptions, the Naval Historical Center must receive all command histories by March 1 of the following year.

For more detailed information, refer to *Command Histories*, OPNAVINST 5750.12 series.

## COMMAND AND FLAG OFFICER BIOGRAPHIES

Biographies of command and flag officers (and C/MCs) are an important part of your public affairs office files. You will use them in media kits, welcome aboard booklets, external releases and other media-related products

The standard biography has 1-inch margins with either blocked or indented paragraphs. There are two spaces between paragraphs.

The first paragraph of a biography mentions where the subject is from and lists educational achievements beyond high school (do not include the birth date). Also mention when officers received commissions and from what source. For an enlisted person, mention when he joined the service and where he attended basic training.

Subsequent paragraphs usually outline (in chronological order) the person's career, listing significant jobs, accomplishments and educational achievements. Devote separate paragraphs to the person's current assignment and his medals and awards.

The last paragraph should indicate the subject's marital status, spouse's name (including maiden name, if applicable) and place of birth. Names of children are included, and — if there is enough space — where they are attending college and serving in the military.

Some additional points to remember when you write biographies are as follows:

- Keep the civilian reader in mind. For example, Commander, Operational Test and Evaluation Force, Atlantic (COMOPTEVFORLANT) may be the correct way to phrase a military title, but it is much easier to understand if you write it like this: "Rear Adm. Clauster is the commander of the Operational Test and Evaluation Force, Atlantic."
- Pay special attention to capitalization. If you are not saying "Commanding Officer Lemming," then commanding officer is not capitalized. The same rule applies to any other billet titles listed throughout the biography, such as executive officer, training officer and company



commander. The rule of thumb for you to follow is this: if the title directly precedes the person's name, you capitalize it. However, if the title stands alone or follows the person's name, you use lowercase. Warfare specialties also are lowercase, as in this example: "He was designated a naval aviator in 1973 . . ."

- Lowercase educational degrees. It is a "master's degree in aeronautical engineering." Also, one receives a degree from or earns a degree at a university.
- Lowercase ranks unless you attach a name to them. One is "commissioned an ensign."
- Use the person's present rank when you refer to him throughout the biography.
- Omit street addresses.

- Keep your biographies to one page. If you can reproduce a photograph of the subject on the biography sheet, place it in the top left or right corner of the page and wrap the text around it.
- Note the month and year of the biography in the lower right-hand corner of the page. By doing this, you can distinguish the latest version of the biography from previous ones.

The biography ultimately belongs to the person about whom it is written. He may have personal reasons for including or excluding certain personal information, so be accommodating. However, you should advise the subject of the style of the biography in a tactful manner.

A sample flag officer biography is shown in figure 16-7.

**ADMIRAL RODENTIA M. "RODDY" NUTRIA IV  
UNITED STATES NAVY  
COMMANDER NAVAL SUBMARINE FORCES  
LAKE PONTCHARTRAIN**

Admiral Rodentia M. "Roddy" Nutria IV, a native of Natchitoches, La., earned his master of science degree in marine electrical engineering at New Iberia University before entering the Navy in 1962 through the NROTC (Naval Reserve Officers Training Corps) program. His first assignment was to the destroyer USS *PRUDHOMME* (DD 949), where he served as electrical officer. Admiral Nutria attended submarine school at New London, Conn., in 1965 and graduated with honors.

He was assigned to USS *JACK CREVALLE* (SSN 440) as "A" division officer and assistant navigator. He returned to submarine school for nuclear training in December 1968 and then served one year at the school as an instructor in the mathematics department. Subsequent tours included USS *HAGFISH* (SSN 441), USS *PLECTOGNATH* (SSBN 111) and USS *CEPHALOPOD* (SSN 443), where he served as executive officer.

From January 1979 to August 1981, he served as the commanding officer of the U.S. Naval Submarine Research Center, Hialeah Gardens, Fla. Following tours included commanding officer, USS *CRAWFISH* (SSN 444); budget officer on the staff of Commander, Submarine Force, U.S. Gulf of Mexico Fleet; and aide to the commander of the Operational Test and Evaluation Force.

Admiral Nutria next commanded Submarine Squadron Nine until reporting as a division director in the Bureau of Naval Personnel in 1989. He was selected for promotion to flag rank in May 1990 and assumed his current duty at that time.

As commander of Naval Submarine Forces, Lake Pontchartrain, Admiral Nutria controls the operations of 59 submarines in the defense of Louisiana's southeastern lake front.

Admiral Nutria's awards and decorations include the Defense Distinguished Service Medal, the Navy Distinguished Service Medal (three awards), Legion of Merit (four awards), Meritorious Service Medal, Navy Commendation Medal with Combat "V" and the Navy Achievement Medal (four awards).

He is married to the former Lulubelle Bogalusa of Marrero, La. They have three children: Lupé, a medical student attending Pacific Western University; Dominica, a Coast Guard lieutenant; and Edwardo, a professional bodysurfer.

8/94

Figure 16-7.—Flag officer biography.

## THE MEDIA

*LEARNING OBJECTIVE: Identify and analyze the various types of media and recognize the media relations responsibilities of the public affairs office staff.*

The Navy is a definite source of news. Some of this news will be good and some bad. Good or bad the rules established for good media relations dictate that all Navy news be treated objectively.

Media will publish or broadcast, and the public will learn about newsworthy events and other information concerning the Navy, whether or not the Navy cooperates. Furthermore, media will decide the interests and newsworthiness of Navy news — not the naval commander or the PAO.

### MEDIA TYPES

Before we examine the elements that help create good media relations, it is beneficial for you to examine and understand all available media. In doing so, you must determine the requirements of each medium and then fulfill these requirements, using the guidelines mentioned later in this section.

At a minimum, your public affairs office should serve the following media and be familiar with their requirements:

- Newspaper
- Radio
- Television
- News services
- Syndicates
- Magazines
- News magazines
- Consumer magazines
- Internal or promotional publications
- Books

#### Newspaper

The newspaper is the oldest medium of mass communication and it remains the backbone of public information. While the number of newspapers

published in America has declined with the ascendancy of television, total circulation is increasing.

There are differences between the metropolitan daily, the suburban or neighborhood daily and the weekly newspaper. Whereas, a metropolitan daily focuses on international, national and top-level local news and features, a suburban daily (or weekly) may limit itself to local and regional news with only brief summaries of national and international news. Suburban newspapers have grown in popularity recently, because of their comprehensive coverage of local news.

#### Radio

Radio became a medium of mass communication in the 1930s. Its advantages are immediacy, variety, mobility and aural appeal. Because of the recent resurrection of the AM news/talk format, the radio listening audience may include nearly every individual in the country.

Radio is conversational, informal, intimate and timely. It has an almost instantaneous reaction time to fast-breaking news, but it is limited to headlines and high points.

#### Television

Television is the newest and most potent of mass communications media. It combines the impact of sight and sound with the immediacy of radio. Communication satellites and roving news teams can relay live telecasts from almost anywhere in the world or even outer space.

Television news programs are network (60 Minutes, 20/20, etc.) or local in origin. Most local stations do live coverage and welcome the opportunity to consider videotapes of significant military news or feature events, including sports.

In many areas, television stations are owned by or closely allied with newspapers. Most use both The Associated Press and United Press International news services.

#### News Services

News services, often called wire services, exist to provide the mass media with coverage they cannot afford to get by any other means.

Currently, there are two predominant wire services in the United States: The Associated Press and the United Press International. You should be aware that there are also several foreign wire services, such as

Reuters (England), Agence France Press (France) and Xin Hua (Peoples Republic of China).

## **Syndicates**

Syndicates are either owned by a large newspaper or chain of papers, or they are the result of cooperative agreements among noncompeting papers. They often provide in-depth stories of what the wire services report as spot news. Examples are as follows: NANA (North American Newspaper Alliance), NEA (Newspaper Enterprises Association), *New York Times*, *Chicago Tribune*, *Los Angeles Times* and the Hearst Headline Service.

## **Magazine**

Magazines may be grouped as news, consumer or internal/promotional publications. Magazines have wide circulation, though they are published less frequently than newspapers.

Requests for help on Navy features made by a national magazine must be approved by CHINFO before information is released or support is given.

## **News Magazines**

News magazines (*Time*, *Newsweek*, *U.S. News and World Report*) are national weekly publications that cover the major news of the week in greater depth than daily newspapers or the electronic media.

## **Consumer Magazines**

Consumer magazines appeal to various special interests of the public. Technology, business, sports, hobbies, theater, gossip and humor are among the major subjects reported. These provide an opportunity to tell a story in greater detail or from a particular point of view. Stories need not be as timely as in a news magazine.

## **Internal or Promotional Publications**

Internal or promotional publications reach the internal and external audiences of companies, agencies, professions or vocations. They are also called trade journals and house organs. *Public Affairs Communicator* is an example of a trade journal.

## **Books**

Many PAOs are asked to assist authors of books dealing with military subjects. More than 30,000 books

are published in this country annually. Because of the continuing importance of the Navy and the armed services as a whole to our society, authors of virtually all classes of books (nonfiction, adult, juvenile, general, text and pictorial) rely on the public affairs office for help in gathering material.

A more in-depth study of the media can be found in the *JO I & C TRAMAN*.

## **ESTABLISHING GOOD MEDIA RELATIONS**

Four key words should govern your relations with representatives of the mass media. They are as follows: **security, honesty, accuracy and promptness.**

### **Security**

Make sure the information you release to the media does not contain security violations. In addition to getting yourself neck-deep in trouble, you may endanger the welfare of your country. You should adopt this slogan: "When in doubt, check it out."

### **Honesty**

Your good name is your most valuable asset. Justify the media's belief and trust in the Navy by playing the news game honestly. Never fake a story or serve a selfish interest. Do an honest, straightforward job of reporting the news. Credit your source. Never plagiarize or use copyrighted material without permission.

### **Accuracy**

Every news release or statement released to the media must be 100-percent accurate. Make one blunder and the media will lose confidence in you. Be sure to check and double-check all statements, names, addresses, dates and numbers. Be sure your personal opinions do not interfere with your media relations. Your job is to tell the facts.

### **Promptness**

A good Navy journalist aims for speed without sacrificing accuracy. Reporters want their material quickly, because competition is keen and the public demands fresh news. As long as you can supply this material the way they want it and in time to meet their deadlines, you can expect cooperation.

## **MEDIA VISITS**

Media representatives visiting your ship or station are considered guests of the CO, even when they are covering an assignment. As guests, they are due the utmost courtesy and respect. As working men and women, they rate your full cooperation and assistance.

If you are assigned to escort a reporter on a tour of the ship or station, plan your route ahead of time. Include as many points of interest as possible within security limits. Be relaxed and natural in your actions. Let the reporter know you know your job, but do not try to talk above your level of expertise. Any experienced reporter can sense a “snow job.”

Reporters may be permitted to travel aboard Navy ships and aircraft to cover news events when this travel is in the interest of the DoD or DON. However, travel must not place the Navy in a position of competing with established commercial transportation facilities along the same route. Transportation furnished is not considered to be in competition with commercial facilities when the travel is necessary for news material to be obtained which is related to the ships or aircraft in which the media representative is embarked or to personnel or cargo on board or when correspondents are invited to report on a matter considered of special interest to the Navy.

While aboard, reporters traveling on Navy ships may transmit their stories using shipboard communications facilities. Specific regulations and procedures for the handling of press traffic are found in Chapter 3 of *PA Regs* and the *Navy Communications Manual*, NTP-9.

For more detailed information regarding media visits, consult Chapters 3 and 4 of the *JO 1 & C TRAMAN*.

## **EXCLUSIVE STORIES**

Exclusive stories are in great demand, especially where competition is strong. It is the policy of Navy public affairs not to release regular news stories on an exclusive basis. A Navy release of general interest usually goes to all outlets on your media mailing list simultaneously.

There are some exceptions to this rule. For instance, if you have an idea for a magazine feature story, it must be written or slanted toward a particular market. Since most magazines demand exclusives, the story would naturally be submitted to one magazine outlet.

Another exception is when a commercial writer develops an idea for an exclusive on his own initiative. When a reporter comes to the PAO with an idea for a story, the writer should be given full cooperation. The idea should be kept in confidence and should not be relayed to other media or made the basis of a Navy release.

If another reporter hits on the same idea, the writer should be told that the first person is already working on that angle. Do not reveal who the other writer is, unless the identity is made obvious by circumstances. If the second person wants to continue on the same idea anyway, the reporter should be given the same cooperation as the first person. However, in a case like this, always tell the first reporter what happened.

The same process should be repeated if a third reporter becomes involved. However, when more than three requests are received for the same information, everybody should be informed that the information cannot be provided on an exclusive basis and the information will be disseminated as a general Navy news release.

## **MEDIA QUERIES**

A media query is a request for information by a reporter, usually made by telephone. This indicates that the reporter needs the information **now** — not tomorrow or next week.

As a rule, you should refer all queries to the PAO if they are other than simple, routine questions. The PAO has the authority to release information and is more likely to know the representative calling.

When your boss is not available, you should answer the query provided the requested information is either releasable or within the limits of security. In most public affairs offices, a set of ground rules is established to cover situations of this type. The first one is to write down the exact question and the name and organization of the caller. Many PAOs use the query sheet shown in figure 16-8.

If the information is not readily available, explain this to the reporter and promise to call back in 5, 10 or 15 minutes, depending on how long it will take you to get the answer. Never brush a reporter off with a vague promise, such as, “I will see what I can find out.” Be courteous — remember you are representing your command and the U.S. Navy.

Once you are off the telephone, start digging up the information. Check the files, consult reference material

QUERY SHEET

Taken by \_\_\_\_\_ Time \_\_\_\_\_ Date \_\_\_\_\_

From \_\_\_\_\_ Of \_\_\_\_\_

Telephone \_\_\_\_\_ Deadline \_\_\_\_\_

Question: \_\_\_\_\_

\_\_\_\_\_  
\_\_\_\_\_  
\_\_\_\_\_  
\_\_\_\_\_

=====  
Date and time of response: \_\_\_\_\_

Response: \_\_\_\_\_

\_\_\_\_\_  
\_\_\_\_\_  
\_\_\_\_\_  
\_\_\_\_\_  
\_\_\_\_\_

Query referred to: \_\_\_\_\_ Date \_\_\_\_\_ Time \_\_\_\_\_

Source of information/coordination: \_\_\_\_\_

\_\_\_\_\_

Approved by: \_\_\_\_\_

Given to: \_\_\_\_\_ Time \_\_\_\_\_ Date \_\_\_\_\_

Method of release: Telephone \_\_\_\_\_ Orally \_\_\_\_\_ Printed \_\_\_\_\_ Other \_\_\_\_\_

Given by: \_\_\_\_\_

Figure 16-8.—Query sheet.

or contact officers who may answer the question with authority. If you run over the time limit, return the call and explain the delay. Always keep in mind that the reporter is probably working against a rapidly approaching deadline.

## **MEDIA INFORMATION KIT**

The media information kit is one way to provide visiting reporters with valuable background information on your ship or station. A typical media information kit contains the following materials:

- Command history
- Pertinent facts about the population of the command
- Welcome aboard booklet
- Biographies of senior officers
- Photographs
- Any other appropriate information that will supplement the subject on which they intend to write

Media information kits can serve many other useful purposes. For example, you may give them to visiting dignitaries or guest observers on fleet exercises and operations. They are used during command public visitations, commissioning ceremonies and other special occasions. Aboard ship they are forwarded with advance news releases to local editors in ports scheduled to be visited. American officials in foreign countries also need kits for publicity purposes when ships visit them.

Use standard-size double-pocket folders to assemble your media information kits. You can arrange material in several different ways, but we recommend placing the command history, photographs and biographies on the left side, and other amplifying information on the right side.

You should review information kits regularly, because the material in them becomes outdated.

## **TOURS**

*LEARNING OBJECTIVE: Identify the purpose of tours and the characteristics and skills required of the one conducting a tour.*

An important part of your community relations efforts center around public tours of the command. Regardless of its size, your command will generate a

great amount of community interest. Therefore, the public affairs office staff conducts tours so visitors can witness the Navy in action firsthand. Tours also carry great recruiting potential.

In general, Navy commands honor requests for tours throughout the year, with certain days set aside for general public visitation, such as Navy Day and Armed Forces Day. (Note the use of the term *general public visitation*. **Never** use “open house” when referring to public tours of your command because it implies unlimited public access.)

Additionally, you will receive tour requests from a wide variety of groups, including (but not limited to) the Boy and Girl Scouts, NJROTC units, veterans’ alumni organizations, junior high/high school classes and other community groups. Sandwiched between these groups are the occasional VIP and celebrity tours.

The availability of your command to provide public tours is driven primarily by the following three factors:

- The security conditions in force
- The personnel available to conduct the tours
- The operational commitments of the command

Now take a look at some of the areas you must become familiar with before you conduct a tour. They are as follows:

- Appearance
- Command knowledge
- Demeanor
- Patience
- Voice projection
- Emergency procedures

## **APPEARANCE**

As you learned in Chapter 1, your appearance must be impeccable. Remember, you represent not only the command but the U.S. Navy. Begin evaluating your appearance by first examining your haircut, and working your way down to the edge dressing on your shoes. Replace old, worn-out ribbons and name tags. Prepare for a tour with the same intensity as if you were preparing for a major command personnel inspection.

## COMMAND KNOWLEDGE

You cannot give a good tour if you do not have a wealth of command knowledge. For instance, say you are conducting a tour of your aircraft carrier for a local community group while in port. A member of the group asks you to describe the different types of aircraft that operate from the deck of the carrier. After a long pause, you say, “Well, that information is in your welcome aboard booklet — let me see if I can dig it out for you.”

Obviously, this is the response of a lazy tour guide. Your credibility, and that of the command, is at stake during every tour. If you cannot answer simple questions without referring to a “safety net,” your tour group will be disenchanted. Before the tour, you should know the mission and history of the command, its hardware, important statistics, and so on. You can do this by giving yourself a mock tour and asking yourself probable questions the day before. Carry a copy of the welcome aboard booklet and refer to it if you run into any rough areas.

## DEMEANOR

It is easy to describe the demeanor you must have when you conduct a tour: **Act like a public affairs professional!** Be enthusiastic during a tour, but do not become asocial gadfly. You are giving a tour to explain the mission and history of your command, not to make lifelong friends or win a popularity contest.

## PATIENCE

Another factor that teams with enthusiasm is patience. Patience comes into play when you try to keep a large tour group on the tour route. You cannot treat the group like a herd of cattle; instead, your instructions must be conveyed in an appropriate tone and accentuated with plenty of “pleases” and “thank-yous.”

Patience also is evident when you are asked a “dumb” question. We all know there is no such thing as a dumb question, but on occasion a tour participant will ask you a question you think is absurd. For example, it is not uncommon for a civilian to inquire about your ribbons and medals or your rating insignia. Sure, you and the 3,500 crew members on your ship know that a crossed quill and scroll represents the journalist rating — but that does not mean Mrs. Earwig, a 45-year-old high school science teacher from Billings, Mont., knows what it is. In this instance, briefly explain the Navy’s occupational fields and rating system with tact and compassion. If you experience an onslaught of similar questions during the tour, handle each one in the same manner, but never vent your frustrations in public.

## VOICE PROJECTION

A tour guide who cannot be heard is of no use to a tour group. Make sure you project your voice with authority, especially at airports or around noisy equipment in the hangar bays. If there is enough money in your public affairs office budget, purchase a megaphone or some other type of portable voice amplification equipment.

While projecting your voice, you should speak slowly and clearly so as to increase your chances of being understood.

## EMERGENCY PROCEDURES

One of your tour participants collapses while you are explaining the functions of the catapults on the flight deck. What happens to the rest of the group while you attend to the ailing person? Who should you call? Where is the nearest telephone?

Answers to these questions are available in the command or public affairs instruction that covers the policies and procedures for public tours. Within this instruction is a section pertaining to emergencies that occur on the tour route. You should become familiar with the entire instruction, but pay particular attention to the section dealing with contingency responses.

If for some reason this instruction is not available at your command, seek the guidance of the senior journalist or the PAO.

You will find more detailed information on tours in Chapter 4 of *PA Regs* and in Chapter 1 of the *JO 1 & C TRAMAN*.

## EQUIPMENT MAINTENANCE

*LEARNING OBJECTIVE: Identify the procedures for maintaining public affairs office equipment, in terms of performing basic user maintenance and inventory.*

As a Navy journalist working in a public affairs office, you will use several pieces of equipment to carry out your mission efficiently. Although today’s “tools of the trade” are state-of-the-art and relatively trouble-free, you must learn the basics of user maintenance to avoid problems at the most inopportune moments.

**NOTE:** The maintenance procedures in this section are rudimentary in nature and are not intended to replace the more detailed methods contained in owner’s/operator’s manuals. Refer to these manuals for further equipment maintenance information.

## BASIC USER MAINTENANCE

In this section you will learn how to maintain the following types of public affairs office gear:

- Typewriter
- Microcomputer
- Overhead transparency projector
- Opaque projector
- Carousel slide projector

### Typewriter

Your typewriter may have a rugged exterior, but it is actually a delicate instrument. Treat it as such and give it daily care. A typewriter in first-class condition is easier to operate and turns out clean, crisp-looking correspondence.

Keep your typewriter covered when you are not using it. Clean it by wiping the outside with a soft, dry cloth.

Occasionally you should give your typewriter a thorough cleaning. The frequency of these cleanings depends on how often you use the typewriter and the amount of dust in your office atmosphere. In general, we recommend that you perform the following procedures once a month:

- Remove the platen or cylinder and wipe it with a cloth moistened with a small amount of denatured alcohol or cleaning fluid. Do not wipe off the alcohol; allow it to evaporate.
- Remove the daisy wheel and inspect it for damage and dirt accumulation. If necessary, clean it with a short bristled brush. Using the points of the bristles, tap the daisywheel lightly to loosen the dirt; then brush it off lightly.
- Remove the casing and clean the interior of the typewriter with a long-handled brush or a soft cloth. Brush toward the front of the machine.

### Microcomputer

Although microcomputer systems are small and generally unobtrusive in the workplace, they require a good deal of operator maintenance. Dirt accumulates on diskettes, disk drives, printers, display screens and keyboards. Static electricity also can be a major problem, especially in areas where humidity is low.

Keep your microcomputer as clean as possible. One way for you to do this is by using dust covers. This, of course, only protects the system when it is not in use. You will still need to clean the following components on a regular basis:

- Floppy disk drive heads
- Keyboard
- Display screen
- Printer

**FLOPPY DISK DRIVE HEADS.**— Clean the floppy disk drive heads with a head cleaning diskette. The instructions that come with the head cleaning kit may direct you to put fluid on the cleaning diskette; then insert the cleaning diskette in the drive and activate (lower) the heads for a few seconds. This helps reduce service calls, and you are less likely to lose data. How often you will need to do this depends on how often you use the microcomputer and whether the area is very dusty.

Some floppy disk drive manufacturers recommend cleaning the heads no more than twice a year. However, we recommend that you clean the heads after 40 to 50 hours of actual use.

**KEYBOARD.**— To clean keyboards, you can use specially angled swabs with cleaning solution or a portable vacuum cleaner (fig. 16-9) that has special attachments to reach between keys. Vacuums of this type usually have dual-filter systems to keep from blowing dust and dirt back into the room. Ultra soft thin bristle brushes also are available for cleaning keyboards.

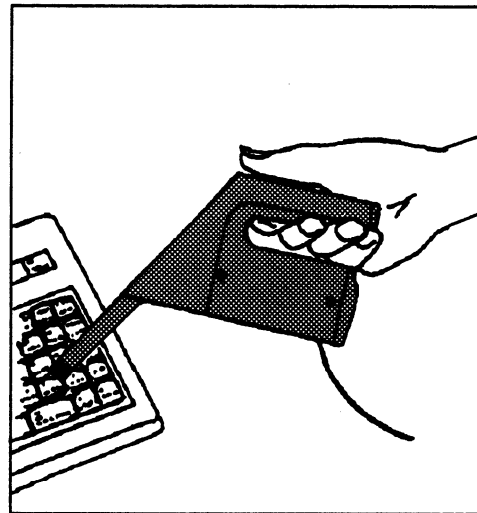

Figure 16-9.—Portable vacuum cleaner.



It is not a good idea for you to use low-pressure air or tamed air (a nontoxic gas under pressure) to clean the keyboard. If you use this method, you may blow dust and dirt into cracks, crevices and electrical components, which may result in future problems.

**DISPLAY SCREEN.**— The display screen needs routine cleaning as well. A dirty screen can be hard to read and may contribute to headaches and fatigue. Dust buildup on the screen can cause static electricity that may result in lost data. You may use a liquid video spray cleaner, but **do not** spray it directly on the screen. Spray it on a lint-free nonabrasive cloth before you contact the screen.

**NOTE:** Many commercial cleaning solvents contain alcohol and other flammable agents. If your display screen is on (energized) when it is cleaned with one of these flammable fluids, combustion can occur. An energized display screen can discharge quite a bit of static electricity — a sufficient amount to ignite alcohol. Therefore, if you intend to clean your screen, turn the monitor **off** first.

You also may clean the screen with wet/dry towelettes. These are convenient to use because the cleaning solution is normally premeasured and they come in individual packets. To reduce static electricity, you can use special antistatic sprays or antistatic pads or mats. Some cleaning solutions include antistatic chemicals.

An antistatic filter for the display screen is another way to reduce static buildup. Antistatic dust covers also may help when the system is not in use.

**PRINTER.**— A printer creates its own dust from being in constant contact with paper. To clean the printer, use a vacuum similar to the one shown in figure 16-9. Cleaning solutions and specially shaped brushes are available for cleaning platens. For cleaning the print heads, you can feed a specially designed print sheet cleaner through the printer just like you feed continuous form paper.

### Overhead Transparency Projector

The overhead transparency projector (fig. 16-10) must be kept as clean as possible for obvious reasons — dirt, dust, hair and other foreign objects that attach themselves to the outside lenses or optical stage will be distracting to the viewer and result in an unprofessional presentation.

Clean the outside lenses and optical stage with an approved lens cleaner or a mild detergent solution and a clean, soft, lint-free cotton cloth. Do not use paper

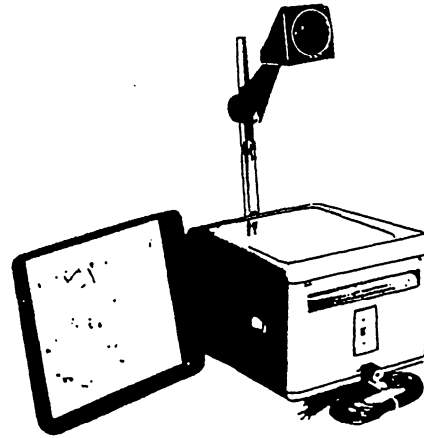

Figure 16-10.—Overhead transparency projector.

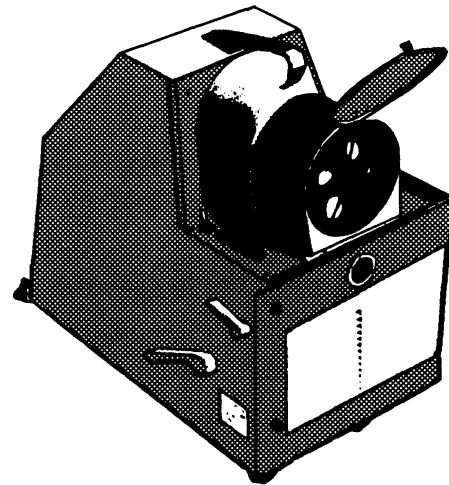

Figure 16-11.—Opaque projector.

cloths because they may scratch these surfaces. Rinse and dry all optical surfaces after cleaning them. Permanent damage can result if they are not rinsed and dried thoroughly. Any accumulated surface dirt on the mirrors should be removed with a camel hairbrush only.

### Opaque Projector

Simple care and occasional cleaning keeps the opaque projector (fig. 16-11) in good working order. Clean its optical elements (projection lens, parabolic reflector, secondary mirrors, front surface mirrors and projection lamp) by wiping them with a lint-free rag, damp chamois or lens tissue.

The front surface mirrors are the most important optical elements of the opaque projector. When you compare an ordinary mirror to a front surface mirror, you will see that the reflective coating of the front surface mirror is fully exposed, hence its name. The

coating of a regular mirror is located at the rear of the glass. Consequently, the front surface mirrors of an opaque projector are extremely delicate. Do not get your fingerprints or other marks on it. If the mirrors are not soiled, then any dust accumulation can be removed with a soft camel hair brush. If they are badly soiled, wipe them very gently with a lint-free cloth or lens tissue. (Use extreme caution when you use the cloth or tissue — they can scratch the surface of the mirror.)

### **Carousel Slide Projector**

The cleaning procedures for the Carousel slide projector (fig. 16-12) are essentially similar to those used for the opaque projector. The Carousel uses a standard mirror, so you should remove surface dirt with a camel hairbrush.

### **EQUIPMENT INVENTORY**

You should maintain an inventory of all your public affairs equipment. The inventory should include the following information:

- Name of equipment (including model numbers)
- Serial number

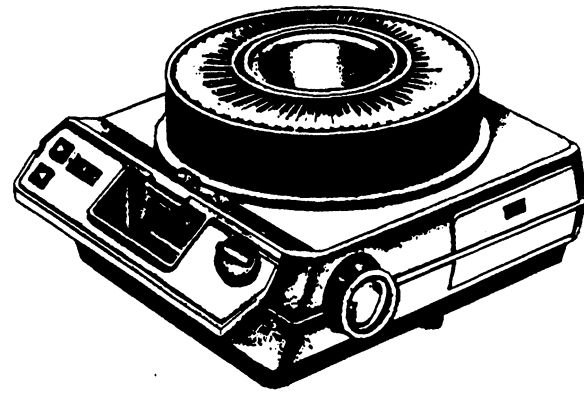

**Figure 16-12.—Carousel slide projector.**

- U.S. Navy minor property number (if applicable)
- Date of purchase or receipt
- Estimated value
- Warranty/service information

Your inventory also should list the dates you performed your maintenance. By doing this, you will take the guesswork out of scheduling maintenance, and in turn, your gear will give you years of trouble-free service.

## CHAPTER 17

# HOME TOWN NEWS

Most of this TRAMAN covers your responsibilities associated with keeping the public informed about its Navy. This chapter progresses along the same lines but focuses on the methods you use to gather and release hometown news about the men and women of the U.S. Navy.

Navy people, not unlike their civilian counterparts, have a desire to be appreciated — to have their achievements and contributions noticed and praised. The Navy's Fleet Home Town News Program provides the most effective and economical means for you to release information about individual sea service members to their hometown news media (fig. 17-1). Your participation in the program also produces the following ancillary benefits:

- Improved command retention
- Improved recruiting Navy-wide
- Increased command readiness through the recognition of its people
- Increased public awareness of the sea services through news stories about the services' education, training and operational missions
- Increased individual and unit morale

The Fleet Home Town News Program is administered by the Fleet Home Town News Center (FHTNC). Further information about the FHTNC and the Fleet Home Town News Program is provided in the following text.

### THE FLEET HOME TOWN NEWS CENTER

*LEARNING OBJECTIVE: Identify the responsibilities of the Fleet Home Town News Center (FHTNC).*

Since 1945, the responsibility for processing and distributing hometown news releases has rested with the FHTNC. Located at Naval Station Norfolk, Virginia, the Center is a field activity of CHINFO. In effect, it acts as a clearinghouse for the sea services by editing, reproducing and mailing homeowners to the media in

communities throughout the United States, American Samoa, Guam and the U.S. Virgin Islands. (In 1992, the Center stopped sending releases to the Republic of the Philippines upon the departure of U.S. forces.)

Through a mutual agreement with the Commandants of the Marine Corps and Coast Guard, the instructions and policies of the FHTNC apply to all Marine Corps and Coast Guard commands, organizations and activities participating in the Fleet Home Town News Program.

You should keep in mind that the Fleet Home Town News Program is not optional for your command — it is required by *Instructions and Policy Concerning Fleet Home Town News Program*, SECNAVINST 5724.3 series. Make sure you examine this instruction in its entirety.

### CLIENTS

Hometown media are the “clients” of the FHTNC, including newspapers, radio and television stations and special interest publications. They neither pay for stories, nor are they obligated to use the material. However, since they must request the material in order to receive it, most of the clients do use it.

**NOTE:** You may not mail hometown news material directly to the media, unless interested media have specifically requested it. SECNAVINST 5724.3 series emphasizes that all hometown news, other than specifically authorized exceptions, must be forwarded via the FHTNC.

The authorized exceptions are as follows:

- Material prepared by recruit training commands concerning special recruit units may be forwarded directly to the activity for placement in local media, when requested by the recruiting activity that enlisted the unit.
- Hometown news material concerning a member of a command whose hometown is in the immediate geographic area (generally within 50 miles) of the command may be placed directly with local media. This provision also may include media in communities where the

## Service Notes



**Kyle M. Parker**  
Navy Seaman Recruit Kyle M. Parker, son of Marine Corps Capt. James M. Cain of Twentynine

### McCoy finishes Navy Hospital Corps School

Navy Hospitalization Recruit Le Talia A. McCoy, daughter of Lottie J. McCoy of 523 Sixth St. in Tallulah, recently graduated from the Navy's Hospital Corps School.

During the course at the Naval School of Health Sciences, San Diego, students receive instruction on basic medical procedures used by hospital corpsmen who assist Navy doctors and nurses.

Course studies also include an introduction to all phases of military health service, x-ray technology, laboratory analysis, general practice and surgery.

The 1991 graduate of McCall Senior High School joined the Navy in January 1992.

Palms, recently completed basic training at Recruit Training Command, Great Lakes, Ill.

During the cycle, recruits are taught general military subjects designed to prepare them for further academic and on-the-job training in one of the Navy's 85 occupational fields.

Studies include seamanship, close-order drill, naval history and first aid.

Parker is a 1992 graduate of Twentynine Palms High School.



**DANIEL S. GAMMON**

Seaman Daniel S. Gammon, son of Air Force Master Sgt. Danny L. Gammon and Janet L. Gammon of San Antonio, Texas, and a grandson of Mr. and Mrs. C.A. Gammon and Mrs. Velma Trosper, all of Bowling Green, was promoted to pay grade E-3 Aug. 1 at Naval Air Station, North Island, Calif. He is stationed aboard the USS Ranger which has been deployed to the Persian Gulf.

He is a 1989 graduate of Lackland High School in San Antonio.

## Clifton Barber returns from deployment

Navy Fireman Clifton O. Barber, son of Richmond and Gertrude Barber of Tallulah, recently returned aboard the guided missile cruiser USS England, homeported in San Diego from a six-month deployment to the Western Pacific.

During the deployment, USS England traveled over 33,000 nautical miles and participated in several exercises with the Australian Navy and Japanese Maritime forces plus other U.S. Navy and Marine Corps units. USS England was part of the last Navy battle group to visit Naval Base Subic Bay, Republic of the Philippines, scheduled to close later this year.

USS England sailors provided humanitarian assistance to a local Olongapo City, Republic of the Philippines, elementary school by painting and making numerous repairs to the aging building as well as purchasing recreation equipment during a port visit to Naval Base Subic Bay.

Assisted by the sailors on USS Antietam, the England also hosted a Texas style barbeque for the residents and staff of a local Pattaya Beach, Thailand, boys' home. The language barrier was broken by the smiles of all involved. Barber visited ports in Australia, Brunei, Hawaii, Hong Kong, Japan, Thailand, Singapore and the Republic of the Philippines.

The 1983 graduate of McCall Senior High School and 1989 graduate of Louisiana Tech University in Ruston, joined the Navy in January 1990.

command maintains direct contact, such as USS *Los Angeles* (SSN 688) with Los Angeles, California. In the case of a namesake ship program, commands should receive guidance from the appropriate NAVINFO.

- Hometown news feature material may be provided directly to any news media making requests for information on specific individuals, subject to the instructions of appropriate operational or other higher echelon commanders governing media relations. Normally, such requests will be coordinated with the appropriate service headquarters or NAVINFO before release.

## SURVEYS

It is the policy of the FHTNC not to send unsolicited releases to the media. Therefore, the Center periodically surveys all potential media clients in the United States and its territories. Those news media editors who want to receive hometown news releases must indicate this on the FHINC survey form.

A recent media survey revealed the following statistics:

- 96 percent always or sometimes use award releases; 84 percent always use them.
- 96 percent always or sometimes use promotion releases; 77 percent always use them.
- 93 percent always or sometimes use school graduation releases; 78 percent always use them.
- 72 percent get feedback from their readers/audience about releases; 98 percent describe that feedback as positive.

## STORY CATEGORIES

*LEARNING OBJECTIVE: Identify the most common hometown news story categories and the appropriate and inappropriate hometown ties.*

Hometown news stories usually fall into one of three categories — military achievement, personal achievement or participation stories. These categories are explained in the following text.

## MILITARY ACHIEVEMENT

Military achievements are those personal newsworthy accomplishments that are job related. Consider the following examples:

- School graduation (**NOTE:** To avoid embarrassment in case of early dismissal, the FHTNC does not process stories about individuals reporting to schools. Additionally, this category applies only to formal training four weeks in length or longer, such as “A” and “C” schools.)
- Personal award
- Advancement or promotion
- Qualification (JOOD, OOD, EAWS, ESWS, etc.)
- Honors earned in school or in training
- Reenlistment
- Lifesaving effort or rescue
- Retirement

## PERSONAL ACHIEVEMENT

Personal achievements are those personal newsworthy accomplishments realized during off-duty hours. Consider the following examples:

- College degree or high school diploma earned
- Award received from the Navy League of the United States or other civic organization, but not commercial firms

## PARTICIPATION STORIES

Participation stories result from an individual’s being a part of his command’s activities. Consider the following examples:

- Reporting aboard
- Deployment or a change in the location of the unit
- Port visit
- Participation in an exercise or operation
- Participation in evacuation operations
- Active duty for training (ACDUTRA)

**NOTE:** The FHTNC does not process feature stories.

### **APPROPRIATE HOMETOWN TIES**

For purposes of this section, the term *hometown* refers to the place of residence of the sea service member's immediate next of kin, a spouse's immediate next of kin, and when appropriate, college alumni publication. Other suitable hometown ties include another blood relative, or an in-law or legal guardian living in a community in the United States or its possessions.

### **INAPPROPRIATE HOMETOWN TIES**

You must not use spouses, dependent children or friends as hometown ties. This will eliminate the possibility of harassment if official duties require the service member to be away from his residence on a regular basis.

### **PROMOTING THE FLEET HOME TOWN NEWS PROGRAM**

*LEARNING OBJECTIVE: Describe the methods used to promote the Fleet Home Town News Program.*

Participation in the Fleet Home Town News Program by individual service members is strictly voluntary. Nonetheless, you should present it in a positive manner to encourage involvement. While some people may not be interested in the "publicity," their relatives and friends back home probably are interested.

Soft sell the program, but do attempt to sell it. If an individual still chooses not to participate, honor the person's decision and do not forward the release form to the FHTNC.

You can sell the program in the following ways:

- Run Plan of the Day notes.
- Make SITE-TV spot announcements.
- Make promotional spot announcements on ship's radio.
- Ask the CO, XO or C/MC to make promotional announcements during Captain's Call.
- Promote the program during command indoctrination classes ("I" Division).

### **PROCESSING FHTNC MATERIALS**

*LEARNING OBJECTIVE: Recognize the correct method of processing FHTNC materials.*

The success of the Fleet Home Town News Program depends on your continuous, active support. Therefore, you should give the people at your command ample opportunities to participate in the program and you should encourage future involvement. A good starting point for you to solicit participation is when military members first report to your command, so make sure the public affairs office is on the command check-in sheet.

### **FLEET HOME TOWN NEWS RELEASE FORM**

At first glance, conducting a home town news program appears to be a monumental task. However, closer observation reveals it is a relatively simple process in terms of meeting public affairs objectives. The FHTNC has simplified the procedures for submitting home town news material by designing a standard release form, the Fleet Home Town News Release Form, NAVSO 5724/1 (Rev. 8-88). You must use this release form for all home town news releases.

**NOTE:** Contact the Center or check SECNAVINST 5724.3 series for the most current release form revision date.

When properly completed (mostly by the individual about whom the release is being made), the release form contains all the information necessary for writers at the FHTNC to prepare the homeowner. Figure 17-2A is an example of a completed NAVSO 5724/1. The reverse side of the release form (fig. 17-2B) carries block-by-block instructions. For this reason, we will not provide a block-by-block breakdown of the release form.

The NAVSO 5724/1 was designed to give uniformity to the Fleet Home Town News Program and to accelerate the processing of home town news releases. They are available through the Navy supply system, so maintaining an adequate number of them should be easy. However, if you run out of release forms, you may use locally produced copies until your stock is replenished. The information may be typed or printed.

**NOTE:** The FHTNC should receive completed release forms no later than 30 days after the event occurs (allowances are made for submarines). After the release forms are processed and the subsequent news releases

# Fleet Home Town News Release Form

- 1. Instructions on Back.
- 2. Print in Ink or Type.
- 3. For Additional Remarks Use Block 23.

<b>1. From: Command/Address</b> Commanding Officer USS Mollusk (FFG 1370) FPO AE 09989-5724 Homeport/Base (not FPO etc.)		<b>2. Command Releasing Authority</b> Print Name Peter J. Murex, LTJG, PA0 Signature <i>Peter J. Murex</i> Duty Phone DSN: 281-1414		<b>3. RUC/UIC/OPFAC</b> 82093	
		<b>4. Circle Branch or Service</b> Active - Reserve <input checked="" type="radio"/> USN - <input type="radio"/> USMC - <input type="radio"/> USCG - <input type="radio"/> USA - <input type="radio"/> USAF		<b>5. Date of Event MM/DD/YY</b> 6/9/94	
<b>6. Rank</b> RMCS	<b>7. Pay Grade</b> E-8	<b>8. Date Entered Service MM/YY</b> 8/77	<b>9. Date Reported this Command</b> 10/8/93	<b>10. Sex</b> M <input checked="" type="checkbox"/> F <input type="checkbox"/>	<b>11. Married</b> Yes <input checked="" type="checkbox"/> No <input type="checkbox"/>
					<b>12. Social Security Number</b> 123-45-6789
<b>13. Your First, Mi., Last Name</b> Emilio S. Vehante			<b>14. Spouse's Name (If Married)</b> Cantranda C. Vehante		
Your Living Parents/or if Guardians or other Relatives Show Relationship - If Military Include Rank/Service					
<b>15. Your Father's First, Mi., Last Name</b> Robert S. Vehante		Address (Number and Street) 4951 W. 14 Lane, Apt. #211			ZIP Code 33012
		City Hialeah			State FL
<b>16. Your Mother's First, Mi., Last Name</b> Carmen S. Vehante		Address (Number and Street)			ZIP Code
		City			State
		<input checked="" type="checkbox"/> Same as BLK 15			
<b>17. Wife/Husband's Father's First, Mi., Last Name</b> Allen P. Rubra		Address (Number and Street) 34 E. 21 Street			ZIP Code 33010
		City Hialeah			State FL
<b>18. Wife/Husband's Mother's First, Mi., Last Name</b> Plumeria F. Rubra		Address (Number and Street)			ZIP Code
		City			State
		<input checked="" type="checkbox"/> Same as BLK 17			
<b>19. High School - Complete Name</b> Hialeah High School		Year Graduated 1977	City Hialeah	State FL	ZIP Code 33010
<b>20. College/University/Complete Name</b>		City	State	Type Degree/ Year	FHTNC Use Only
<b>21. College/University/Complete Name</b>		City	State	Type Degree/ Year	FHTNC Use Only
<b>22. Duty to Which Assigned/Job Title - If Designated a Plane Captain, etc.-List Type Aircraft, Etc.</b> Communications Center LCPO					
<b>23. Event-Check Appropriate Box or List Complete Details-Use extra Paper or attach copy of citation, etc.</b> <input type="checkbox"/> Reported <input checked="" type="checkbox"/> Promoted to Above Rank <input type="checkbox"/> Meritoriously <input type="checkbox"/> Medal/Award Attach Copy <input type="checkbox"/> Reenlisted Years <input type="checkbox"/> Retired Years					
<b>24. PRIVACY ACT STATEMENT - AUTHORITY: 5 U.S.C. 301, and 14 U.S.C. 93f and 10 U.S.C. 8012 and 8034, and EO 9397. PRINCIPAL PURPOSE:</b> To prepare news stories and news releases for distribution and publication by civilian news media to recognize the achievements of sea service members. SSAN is used for positive identification. ROUTINE USE: Information may be disclosed to civilian news media representatives. Once published, information is considered "Public Domain." DISCLOSURE IS VOLUNTARY: Failure to provide the information may mean little or no public news release material can be produced, thus denying the individual public recognition for personal achievements.					
<b>25. I certify that the above information is correct and I have no objection to its publication.</b> Signature <i>Emilio S. Vehante</i> Date 6/9/94					
For Reserve Use Only - See Instructions on Back					
<b>26. Your Address (Number and Street)</b>		City	State	ZIP Code	
<b>27. Company Name</b>		Address (Number and Street)			Position/Years with Company
		City			State
		ZIP Code			
<b>28. Company Publication</b>		Address (Number and Street)			FHTNC Use Only
		City			State
		ZIP Code			

NAVSO 5724/1 (REV. 8-88)  
 S/N 0104-LF-000-2600

This form supersedes all previous editions which may not be used.

Figure 17-2A.—Completed NAVSO 5724/1 (front).

## INSTRUCTIONS

1. List complete command mailing address including homeport or base.
2. Name and signature of person at command who authorized form for release. Must be signed on each form, unless a group of forms (10 or more) is submitted under a signed cover letter. List duty phone. Indicate if AUTOVON or Commercial.
3. Reporting unit code (USMC), unit identification code (USN), or operating facility code (USCG).
4. Self explanatory.
5. Actual date of event or date of presentation in the case of awards.
6. Rank such as SGT or J03.
7. Pay grade such as E-6 or O-2.
8. Date entered active duty, if you delayed enlisted, etc., also indicate date and explain.
- 9., 10. and 11. Self explanatory.
12. Social security number is mandatory. SSN is for FHTNC use only in casualty searches. SSN is not released to media.
- 13., 14., 15., 16., 17., and 18. Self explanatory. (NOTE – ZIP Codes mandatory for release preparation.)
19. Self explanatory.
20. and 21. Include type of degree (BA, BS, AA, etc.) and year awarded. List only two highest degrees.
22. Indicate your duties by job title, (e.g. squad leader, cook, plane captain, etc.) not by NEC/MOS/QC.
23. Check appropriate box or give complete details of event – use extra paper as required. Attach copies of citations/awards, etc. If qualified as pilot, etc., list type. aircraft, etc.
24. Self explanatory.
25. Payroll signature required to permit release of news story.
26. Self explanatory.
27. Complete company name, address, your position/job with the company and number years employed with company.
28. Name of company publication/newsletter that you want story released to. Include complete address and ZIP code.
29. Fleet Home Town News Center telephone number is: (804) 444-2221, AUTOVON: 564-2221.
30. Mail to: Fleet Home Town News Center, Building X-18, Naval Station, Norfolk, VA 23511-6698.

**Figure 17-2B.—Completed NAVSO 5724/1 (back).**



are mailed, the forms are maintained for 90 days in an alibi file and then destroyed.

On occasion, a few release forms do not get processed and are returned to the activities that submitted them. Along with the returned release forms is a short explanation listing the reason(s) they were not accepted. There are several reasons a particular release form may not be processed. It could be that there are no media in a particular community or area that desires the stories. The release form might be received without the required signatures, or there might not be enough information with the release form to develop a meaningful release.

You can reduce the number of nonreleased forms by following all of the directions on the back of the NAVSO 5724/1. Check all blocks on the front of the release form for completeness, accuracy and legibility before the release form is mailed to the FHTNC.

### **Log Book/Index File**

You should maintain a 90-day logbook or index file of each release form mailed to the FHTNC. The record should include the following information:

- Name and social security number of the individual
- News event
- Date mailed

By tracking your release forms in this manner, you can work with the Center in purging release forms that belong to an injured or deceased crew member. It is embarrassing when a release is made on an individual's participation in an exercise when he was discharged months earlier. More important, the release of a story about an individual who "recently visited Sasebo, Japan," when in fact he was hospitalized or deceased, will cause confusion and additional grief to family members.

The FHTNC is an addressee on all death or serious injury messages. Upon receiving a casualty message, the Center immediately inputs the social security number of the casualty into the computer system. The computer indicates whether a news release is currently being processed or has been mailed out on that individual, as well as the names of the hometown media that received it. If the release has left the Center, the appropriate media outlets are called immediately and requested not to run the story.

### **Command Releasing Authority**

Each submission to the FHTNC must be authorized for release and verified for accuracy by the submitting command. The command's "releasing authority" may be whoever the commander has designated to conduct the fleet home town news program within his unit (usually the PAO, but it can be a JO). The command releasing authority prints and signs his name in block two of the release form and indicates his duty telephone number.

### **Social Security Number**

Make sure the service member understands that the social security number listed in block 12 will not appear on the actual news release. It is required solely to track casualties.

### **PHOTOGRAPHS**

Good photographs enhance the potential use of home town news releases. Either formal or informal portraits are useful hometown news photographs. These photographs range from the basic head and shoulders picture (mug shot) to a shot of the individual in a working environment. The individual's face should be clearly identifiable in the photograph.

The FHTNC prefers at least five black-and-white wallet-sized prints for each submission. The wallet-sized prints will fit easily in standard business-sized envelopes. However, if you must mail larger prints, the FHTNC will accommodate you.

Do not send negatives to the FHTNC, as it does not have the capability to work with them.

Most of the print media editors on-line at the FHTNC enthusiastically request more photographs. The Center sends out all photographs it receives, informal or formal, as long as amplifying information (identification of people, description of the event taking place, etc.) is included on the back of each photograph. Type this information on a separate piece of paper or on a label and attach it to the photograph. Your doing this prevents "bleed-through," a common occurrence when you write on the back of a photograph with a ball-point pen. Put the photograph in an envelope and attach it to the completed NAVSO 5724/1.

### **LETTER OF TRANSMITTAL**

If you send nine or fewer release forms to the FHTNC at one time, the command releasing authority

**USS MOLLUSK (FFG 1370)  
FPO AE 09989-5724**

5724  
Code  
Date

**From:** Commanding Officer, USS MOLLUSK (FFG 1370)  
**To:** Director, Fleet Home Town News Center, Building X-18,  
Naval Station, Norfolk, VA 23511-6698

**Subj:** FORWARDING OF HOME TOWN NEWS MATERIAL

**Ref:** (a) SECNAVINST 5724.3

**Encl:** (1) NAVSO 5724/1 release forms (reporting aboard) (12)  
(2) Deletions to Hold File (9)

1. Enclosure (1), which is forwarded per reference (a), has been verified for accuracy and is authorized for release.
2. Add enclosure (1) to Hold File after processing.
3. Delete names in enclosure (2) from Hold File.

**P. J. MUREX  
By direction**

Figure 17-3.—Letter of transmittal.

must complete block two of the release form. However, if a single mailing consists of 10 or more release forms, you must include a cover document called a letter of transmittal (fig. 17-3).

A letter of transmittal serves several purposes. It makes the transaction official and gives the FHTNC authority to process the story. In addition, it aids the Center in processing the material faster by indicating the type of material submitted, the general subject matter and the number of stories involved.

Letters of transmittal must be signed by the CO or an officially designated representative (such as the PAO). Send only the original copy of the letter to the FHTNC.

### **HOLD FILE**

*LEARNING OBJECTIVE: Interpret the policies regarding the submission of a hold file to the FHTNC.*

A hold file is a roster package of NAVSO 5724/1 release forms submitted by a unit when it deploys. The

hold file provides a rapid means of generating timely and newsworthy releases about the accomplishments, achievements and travels of your crew, either individually or as a group.

Hold files are maintained by the FHTNC for the length of the deployment and are normally returned to the command once the deployment is completed. If your unit is not deployed, you should maintain an updated roster package in your office anyway. In the event that your unit must deploy on short notice, you can submit a hold file with little effort.

Any unit departing on an extended deployment (usually two months or longer) should forward a hold file to the Center. If your unit will be involved in exercises or special operations of shorter durations, seek the guidance of the FHTNC.

### **MAILING THE HOLD FILE**

You should update and verify all the release forms in your hold file 30 days before your unit deploys. Mail the hold file to the FHTNC when you are 20 days from the deployment date. Make sure it is in alphabetical

FM USS MOLLUSK .  
TO FHTNC NORFOLK VA

UNCLAS //NO5720//

SUBJ: DEPLOYMENT STORY

A. MY LTR 00:JPJ:DJ 5724 OF 20 SEP 1994

1. HOLD FILE (HF) SUBMITTED WITH REF A VERIFIED ACCURATE.
2. REQ IMMEDIATE PROCESSING OF DEPLOYMENT STORY CONTAINED IN REF A FOR MY HF.

BT

Figure 17-4.—Hold file message.

order by last name and accompanied by a letter of transmittal. We recommend that you include the deployment information or story in the letter of transmittal.

**NOTE:** When you submit stories for release, the Center does not require strict adherence to journalistic style. Since the FHTNC is ultimately responsible for editorial action, all you need to include is a brief synopsis of the facts that answer the five Ws.

Before the hold file is sealed and on its way to the FHTNC, you should make a copy of each release form and store each one of them in an appropriately marked office file. Your hold file should be an exact duplicate of the one received by the Center. This is extremely critical, especially when you must change data or pull a release form in the event of a death or injury.

## PROCESSING THE DEPLOYMENT STORY

When a unit deploys, the PAO or his representative normally sends a message to the FHTNC that contains the following information:

- The authority for the FHTNC to process the deployment story.
- The date the story should be processed (usually without delay).
- Verification that the hold file is accurate and up-to-date.

Once the message is sent, the Center can work on writing the deployment story, which will result in a release for all of the release forms in the hold file.

An example of a hold file message to the FHTNC is shown in figure 17-4.

## SENDING STORIES BY MESSAGE

Once the hold file is at the Center, you may send several different types of stories by naval message. The mid-deployment story (fig. 17-5) and end of deployment story (fig. 17-6) are good ways to get multiple releases for each release form submitted

Further, you should pursue the types of stories mentioned earlier — those dealing with the military or personal achievements of individuals. Doing this in connection with your hold file is easy. For instance, say Lt. Cmdr. Nunez is awarded the Meritorious Service Medal. When you advise the Center of the award (and include amplifying information from the medal citation), Lt. Cmdr. Nunez's release form will be pulled from the hold file and the story will be processed. The release form will then be returned to the file.

## UPDATING THE HOLD FILE

Hold files have a 60-day life cycle. When you send a hold file to the FHTNC, the cycle begins on the day the Center receives it.

At day 50, your unit will be sent a message advising that the file will be returned in 10 days unless it is updated. Each time you update your hold file, another 60-day cycle begins.

The FHTNC considers an update as any communication regarding the hold file. It may be a list of names to be deleted or a list of release forms for persons who have reported to the command, or simply a

FM USS MOLLUSK  
TO FHTNC NORFOLK VA

UNCLAS //NO5720//

SUBJ: PROPOSED MID-DEPLOYMENT STORY

- A. SECNAVINST 5724.3
- B. MY HOLD FILE

1. IAW REF A, FOL PROPOSED MID-DEPLOYMENT STORY SUBMITTED FOR APPROVAL AND RELEASE BY FHTNC WITH REF B:

QUOTE. THE GUIDED MISSILE FRIGATE USS MOLLUSK, HOMEPORTED AT NORFOLK, VA, IS MIDWAY THROUGH A SIX-MONTH DEPLOYMENT TO THE MEDITERRANEAN SEA AS PART OF THE TEN-SHIP USS LIMPET AIRCRAFT CARRIER BATTLE GROUP. USS MOLLUSK HAS PARTICIPATED IN THE NATO EXERCISE DISPLAY DETERMINATION AND HAS OPERATED WITH ALLIED NAVIES FROM ITALY, UNITED KINGDOM, FRANCE, SPAIN, GREECE AND TURKEY. THE SHIP HAS MADE PORT VISITS AT ROTA, SPAIN; NAPLES, ITALY; AUGUSTA BAY, SICILY; AND TOULON, FRANCE. AT AUGUSTA BAY, CREW MEMBERS FROM THE MOLLUSK DELIVERED PROJECT HANDCLASP MATERIALS TO AN ORPHANAGE AND REPAINTED THE EXTERIOR OF A SCHOOL FOR HANDICAPPED CHILDREN AT SIRACUSA, SICILY. END QUOTE.

BT

Figure 17-5.—Mid-deployment story.

FM USS MOLLUSK  
TO FHTNC NORFOLK VA

UNCLAS //NO5720//

SUBJ: END OF DEPLOYMENT STORY

- A. MY HOLD FILE (HF)
- B. MY 010101Z DEC 94
- C. MY 010202Z JAN 95

1. RETURNED TO NORFOLK AFTER A SIX-MONTH DEPLOYMENT TO THE MEDITERRANEAN SEA AS PART OF THE TEN-SHIP USS LIMPET AIRCRAFT CARRIER BATTLE GROUP. DURING THE DEPLOYMENT, THE SHIP STEAMED 15,000 MILES AND EARNED ITS SECOND CONSECUTIVE BATTLE EFFICIENCY "E" AWARD. THIS DEPLOYMENT MARKED THE SEVENTH TIME USS MOLLUSK DEPLOYED TO THE MEDITERRANEAN SEA.
2. HOLD FILE VERIFIED ACCURATE EXCEPT DELETE ENS CARABOK, A. K.
3. REQ END OF DEPLOYMENT STORY FOR REF A. REFS B AND C PROVIDE ADDITIONAL DETAILS ABOUT THE DEPLOYMENT.
4. REQ RETURN REF A AFTER PROCESSING.

BT

Figure 17-6.—End of deployment story.

FM USS MOLLUSK  
TO FHTNC NORFOLK VA

UNCLAS //NO5720//

SUBJ: HOLD FILE (HF) UPDATE

1. REQ FOL DELETIONS TO HF:

JO1 PRONOUN, A. L.  
MMCS WRENCH, C. P.  
DTC FLUORIDE, B. R.  
HM3 PLASMA, R. K.  
MS2 BUFFET, F. Y.

2. FOL PERS HAVE BEEN PROMOTED TO PRESENT RANK:

PC1 DRAM (CAPPED)  
LCDR GUI  
YN2 DEFRAG  
TM2 BERNOULLI  
BT1 QWERTY

3. FOURTEEN ADDITIONAL RELEASE FORMS MAILED TO YOU THIS DATE FOR INCLUSION IN HF.

4. WITH PARA 1 AND 2 CHANGES, HF VERIFIED UP-TO-DATE.

BT

Figure 17-7.—Hold file update message.

declaration that the hold file is current and accurate. A hold file update message is shown in figure 17-7.

### HOLD FILE DISPOSITION

After the end of deployment story is processed, the FHTNC retains the hold file for 30 days in an alibi file before it is returned to the originating command. You also may request that the Center destroy the hold file.

### RUN AND RETURN STORIES

Consider the following scenario: Yesterday, 25 members of your command received awards for their participation in the base “Adopt-A-School” Program. A check of your files reveals that all of the awardees have release forms on file in your office. Your unit is not deployed and it is not scheduled to deploy for about a year. How should you submit the release forms without breaking the integrity of your “inactive” hold file?

The answer is simple — at the top of each release form, mark “**RUN AND RETURN**” before you mail them to the FHTNC. After processing the release forms and holding them for 30 days, the Center will return them to you so you may keep your hold file intact.

**NOTE:** Make sure the information on “run and return” stories is current before they are mailed to the FHTNC.

### HINTS AND REMINDERS

*LEARNING OBJECTIVE: List the hints and reminders used in connection with processing home town news stories.*

The following hints and reminders are offered as a checklist to help you get the most out of the Fleet Home Town News Program:

- Use only the latest edition of the Fleet Home Town News Release Form (NAVSO 5724/1).

- Follow the block-by-block instructions on the back of the NAVSO 5724/1.
- Make sure the person to which the release pertains fills in his social security number in block 12 of the release form.
- Make sure the person to which the release pertains reads and understands block 24 of the release form (Privacy Act statement).
- Submit release forms on individuals with hometown ties only in the United States, American Samoa, Guam and the U.S. Virgin Islands.
- Screen the release forms for legibility, accuracy and completeness before submission
- Keep file copies of the messages or letters you send to the FHTNC to use as a ready reference.
- Make sure the letter of transmittal or block two (command releasing authority) of the release form is signed before mailing.
- Submit only current news items.
- Check your hold file frequently. Make sure you update your release forms when people are promoted qualify or reenlist.
- Do not submit release forms marked “Do Not Release.”
- Do not request the stories be sent to specific media.

## APPENDIX I

# GLOSSARY

- AC**— Alternating Current. The type of electrical current available from standard wall outlets.
- ACTION**— In still photography, movement within a scene being photographed.
- AD LIB**— Extemporization of lines not written in the script; improvised, impromptu or off-the-cuff remarks.
- ADVANCE STORY**— A story written to promote a scheduled special event.
- AFRTS**— Armed Forces Radio and Television Service. Provides its outlets (including NBS detachments) with broadcasting materials.
- AFRTS-BC**— Armed Forces Radio and Television Service Broadcast Center. Provides radio and television program materials through the AFRTS Satellite Network (SATNET), on the Armed Forces Satellite-Transmitted Radio Service (AFSTRS), and AFRTS-BC Affiliate Information Network (AIN) teletype service.
- AFSTRS**— The tied Forces Satellite-Transmitted Radio Service.
- AGIATION**— The process of moving a photographic film, plate or paper in a processing bath or moving the bath relative to the photographic material during processing.
- AMPLITUDE**— The range or strength of an electrical signal.
- APERTURE**— In an optical system, an opening through which light can pass.
- ART**— A general term for all newspaper and magazine illustrations, including the flag.
- ASPECT RATIO**— In television, the proportional relationship of the width of the screen to the height of the screen. The aspect ratio of any television screen, regardless of its physical size, is 3:4 — three units high and four units wide.
- ASSEMBLE EDITING**— In television, an editing mode where the editing control unit (ECU) adds control track and program footage (both audio tracks and the video track) to the edit/record videocassette recorder (VCR) at a predetermined in-edit point.
- ATTRIBUTION**— The act of referring to the name of a person in a news story who makes a statement that may be challenged.
- AUDIO CONSOLE**— In radio and television, the main board to which microphones, cartridge machines, reel-to-reel tape recorders/reproducers, remote lines, CD players and other audio equipment are connected.
- AUDITION**— In radio, the nonprogram channel on an audio console.
- AUTOWINDER**— A mechanical device (used with a 35mm single-lens reflex (SLR) camera) that advances the film after each manual exposure.
- BACKGROUND BRIEFING**— A briefing usually delivered by the PAO to give reporters background information about a particular subject. The content or source of a story written from a background briefing is usually attributed to a “Navy spokesperson,” “informed military sources” or some other truthful, but not specifically identified, individual imparting the information.
- BACKLIGHTING**— In still photography and television, the type of lighting effect created when the light source is in front of the photographer and behind the subject. Backlighting is used to separate the subject from the background by casting a rim of light across the head and shoulders of the subject.
- BALANCE**— (1) In still photography, the process of placing elements of balance, such as objects, shapes or tones, in opposing sections of a photographic composition so that each section appears to have an equal amount of weight or value. (2) In radio and television, the process of adjusting the levels of two or more sound sources in a program so each is heard at the proper comparative volume.
- BARN DOORS**— In television and still photography, metal flaps connected to the body of a lighting instrument used to control light dispersion.

- BAYONET MOUNT**— A means of quickly attaching or removing a lens or falter by turning through only part of a revolution.
- BIOGRAPHY**— A sketch of a person's naval career, normally written for command and flag officers (and C/MCs).
- BLUELINE**— A replica of a newspaper in reverse; compatible to a blueprint.
- BLUEPRINT**— The layout sheets of a newspaper on which a detailed plan or sketch shows the arrangement of art, heads and copy. The blueprint guides the compositor in making up the actual pages.
- BOARD FADE**— In radio and television, the act of turning the master audio pot or appropriate video controller to its full off position. Used in emergency situations.
- BODY**— The main part of a story that supports the lead and the bridge (if applicable) by telling the full story in detail.
- BORDER**— An ornamental or finishing rule used around the edge of printed matter.
- BORDER AREA**— In television, the portion of a graphic that helps prevent damage, eases handling, compensates for improperly framed shots and serves as a bleed-off area for overscanned television sets.
- BOX**— An enclosure of rules or border used around a headline or story to give a more prominent display.
- BRIDGE**— In newswriting, a connecting sentence or paragraph between the lead and the body of a stay.
- BULK FILM CHAMBER**— A long-length roll film magazine designed to handle enough film for 250 or more exposures.
- BURNING IN**— *See* DODGING.
- C/MC**— Command Master Chief.
- CABLE RELEASE**— A device consisting of a stiff wire encased in an outer flexible covering designed to trip a camera shutter without touching the camera itself. One end is threaded to fit the shutter, and the other has a thumb-operated plunger.
- CAMCORDER**— An electronic news gathering (ENG) camera that combines a camera, video cassette recorder and microphone in one unit.
- CAMEL HAIR BRUSH**— A term used to define any brush with superfine, soil bristles used for dusting lenses and front surface mirrors.
- CAMERA**— A lighttight chamber, usually fitted with a lens, through which the image of an object is recorded on a light-sensitive material.
- CAMERA, CONVERTIBLE**— An electronic news gathering (ENG) camera that maybe converted for use in a television studio.
- CAMERA, ENG**— A television camera powered by batteries and used for electronic news gathering (ENG) news assignments.
- CAMERA, STUDIO**— A television camera mounted on a pedestal that allows the camera operator to wheel it to different locations easily during shot changes.
- CAMERA OPERATOR**— In television, a member of the studio production team who operates the studio camera according to the instructions of the director.
- CAPTION**— A small headline or display line sometimes used with a cutline. (**NOTE:** The word *caption* also is used as a synonym for the word *cutline*.)
- CARD, CHROMA KEY**— In television, a visual created when the image from one video source is inserted into the picture of another video source.
- CARD, COMBINATION TITLE**— In television, a visual consisting of lettering against pictorial information (either artwork or photography). The lettering may be either on the card itself or on an overlay.
- CARD, PLAIN TITLE**— In television, a visual consisting of printed lettering (without any pictorial background), such as the title of the show and the name of the performers and producer.
- CARD, STUDIO**— In television, a visual consisting of a mounted photograph or illustration, sometimes accompanied by words.
- CARD, SUPER/KEY**— In television, a visual created when the lettering of a card is superimposed electronically over another background (or over another picture) from another camera.
- CARET**— A character (^) used to denote where corrections are to be inserted in copy.
- CART**— *See* CARTRIDGE.



- CARTRIDGE**— A continuous loop of tape encased in plastic and used to play music and sound effects. It is played in a cartridge machine and recues itself automatically after each use. Commonly referred to as a “cart” in the broadcast industry.
- CATHODE-RAY TUBE**— In television, a vacuum tube using a controlled beam of electrons that strike a fluorescent target (the television screen) and emit light.
- CCU**— Camera Control Unit. In television, a device consisting of a waveform monitor, television monitor and shading control used by technicians to monitor and adjust the video levels of a studio camera. The CCU is normally located in the television control room.
- CD**— *See* COMPACT DISC.
- CHANGE TRANSMITTAL**— The medium used to transmit changes to an instruction, and under special circumstances, a notice.
- CHARACTER GENERATOR**— In television, a computer graphics system used to create letters and numbers in a variety of sizes and fonts.
- CHINFO**— Chief of Information. Normally a rear admiral who is responsible for the development of Navy public affairs guidance.
- CHROMA KEY**— In television, an electronic special effect that combines two video sources into a composite picture, creating the illusion that the two sources are physically together.
- CIRCUIT**— In radio and television, a group of Navy Broadcasting Service (NBS) detachments or Shipboard Information, Training and Entertainment (SITE) equipped ships that receive the same weekly package of program material units on a sequential basis from the Armed Forces Radio and Television Service Broadcast Center (AFRTS-BC). All circuits within a specific geographical area are overseen by a circuit manager.
- CLOSE-UP (CU)**— In television and still photography, a shot in which the talent or subject is of primary interest and only a small segment of the background is discernible.
- COLOR BARS**— In television, a color standard used to test and align color television equipment.
- COLOR TEMPERATURE**— The apparent color of a light source in terms of its relative blue or red content. Color temperature is measured in degrees Kelvin (K).
- COLORS, PRIMARY**— In still photography and television, blue, green and red.
- COLORS, SECONDARY**— In still photography and television, cyan, yellow and magenta.
- COLUMN INCH**— An area that’s one column wide and one inch deep and is used in measuring the contents of a newspaper page.
- COLUMN RULE**— A thin, vertical line used to separate columns of type and to separate unrelated items, such as photographs and stories, from the rest of the page.
- COMMAND HISTORY**— (1) The only overall account of the activities and achievements of a U.S. Navy command. Annual command histories are housed at the Naval Historical Center in Washington, D.C. and serve as the eventual basis for published naval histories. (2) The portion of a welcome aboard booklet or media information kit that briefly summarizes the history of a command.
- COMMAND PRESENTATION**— A visual presentation that covers the mission and history of a command. It is usually narrated live from a script and accompanied by either overhead transparencies or 35mm slides. The command presentation also may be recorded on videotape.
- COMMAND RELEASING AUTHORITY**— The individual designated by the commander to release home town news in block two of the Fleet Home Town News Release Form (NAVSO 5724/1). .
- COMMAND WELCOME INFORMATION**— *See* WELCOME ABOARD BOOKLET.
- COMPACT DISC**— A 4 3/4-inch plastic platter with digitally encoded audio. When inserted in a compact disc player, the disc is seamed by a laser beam positioned above it, thus producing superior audio.
- COMPILATION CUTTING**— In television, a videotape editing technique whereby segments are tied together through narration.
- COMPUTER GRAPHIC**— In television, an electronic picture stored digitally in a computer that may be recalled for airing or altering by a graphic artist.
- CONTACT PRINTING**— In still photography, a method of printing whereby the print produced is in immediate contact with the original or negative. These prints are the same size as the original or negative.

**CONTINUITY CUTTING**— In television, a commonly used videotape editing technique for news or feature releases when the storytelling is dependent on matching consecutive scenes. Continuity cutting includes the cutaway and cut-in.

**CONTRAST**— In still photography and television, a general term referring to differences among extremes of tone values in negatives, prints and subject or lighting. When the difference is great, the contrast is called high, hard or contrasty; when the difference is slight, the contrast is soft, flat or low.

**COPY**— A term used to describe all news manuscripts and text or artwork to be printed in a publication.

**COPY EDITING**— The process of locating and correcting inaccuracies in a news manuscript before they can be printed and distributed.

**COPY EDITING SYMBOLS**— A special set of symbols used by a copy editor to make corrections, additions or deletions in copy.

**COPYRIGHT**— The exclusive right of possession given an individual by law to protect his literary works; musical works (including any accompanying words); dramatic works (including any accompanying music); pantomimes and choreographic works; pictorial, graphic and sculptural works; motion pictures and other audiovisual works; and sound recordings.

**COUNTDOWN LEADER**— In television, the numbers that appear on videotape before the actual program begins. Countdown leader is used to facilitate precise cuing.

**CREATED NEWS**— News that is generally concerned with something the Navy, or some person or organization has done or plans to do and wants the public to know about.

**CREDIT LINE**— The final portion of a cutline used to acknowledge the originator of a photograph.

**CROP**— The act of blocking out unwanted portions of a photograph, either by cutting the print or by enlarging or contact printing.

**CROSSCUTTING**— In television, the use of shots from two different actions or events that will finally be related.

**CUE**— (1) In radio and television, the act of presetting programming materials so that they are available for immediate airing. (2) The signal given to the talent by the floor manager, meaning “begin action” or “start talking.”

**CUE DOTS**— In television, the small, white squares that appear in the upper right-hand corner of the television screen when certain Armed Forces Radio and Television Service (AFRTS) videocassettes are played. Programs on multiple videocassettes are cue-dotted at 10, seven and two seconds from the end of each tape, except the last tape of the program.

**CUTAWAY**— In television, a secondary action shot used to change positions, movements or characters or to denote a lapse of time.

**CUT-IN**— In television, a primary action shot from the main scene that is relevant to the mood or action.

**CUTLINE**— The explanatory matter that accompanies a photograph. A cutline supplements a photograph by explaining action, naming people and giving background information.

**CUTOFF LINE SYSTEM**— In television, natural dividing lines that assist the director in producing aesthetically pleasing shots.

**CUTOFF RULE**— A rule or line placed horizontally across one or more columns to separate units, such as boxes and multicolumn heads, from the rest of the page.

**CYLINDER**— *See* PLATEN.

**DAISY WHEEL**— In typewriters and printers, the mechanism used to print keyboard characters. The individual characters of a daisy wheel are mounted in a circular pattern and connected to a hub with spokes; the whole unit resembles a daisy. When a character on the keyboard is depressed, the daisy wheel rotates until the correct character is in place.

**DATELINE**— The lead-in line of a cutline or story that gives the point of origin.

**dB (DECIBEL) GAIN SWITCH**— In television, a switch used to increase the video output of a camera. The dB gain switch normally has two positions — 6dB and 12dB.

**DC**— Direct Current. The type of electrical current available from batteries.

**DEPTH**— In still photography, an illusion of three-dimensional space that is sometimes created by a combination of favorable lighting and coloring of the set and favorable viewing conditions for the reproduction.

**DEPTH OF FIELD**— The distance between the points nearest and farthest from the camera that are acceptably sharp at a given lens setting.

- DESIGN**— The function of planning for the total structure of a newspaper page before any layout work is done.
- DESIGN, BRACE**— *See* DESIGN, FOCUS.
- DESIGN, CIRCUS**— A traditional front-page newspaper design pattern in which each individual element competes for the reader's immediate attention, resulting in no clear focus of interest on the page.
- DESIGN, FOCUS**— A traditional front-page newspaper design pattern in which the headlines and pictures are positioned on the page to form a diagonal line from the upper left-hand corner to the lower right-hand corner.
- DESIGN, FUNCTIONAL**— A contemporary front-page newspaper design pattern in which the page is made up in a reamer that will be most appealing and convenient to the reader.
- DESIGN, GRID**— A contemporary front-page newspaper design consisting of modules of varying sizes with the grid lines formed by the spaces between columns and the spaces separating stories.
- DESIGN, HORIZONTAL**— A contemporary front-page newspaper design pattern where elements are placed on the page. The page is made up with the elements being placed on the page so the majority of the elements present a horizontal display.
- DESIGN, MODULAR**— A contemporary front-page newspaper design pattern where pleasing blocks (modules) of vertical and horizontal rectangles are combined.
- DESIGN, RAZZLE-DAZZLE**— *See* DESIGN, CIRCUS.
- DESIGN, SINGLE THEME**— A contemporary front-page newspaper design that emphasizes a single, important story or issue without the use of stories or reefers.
- DESIGN, TOTAL THEME**— A contemporary front-page newspaper design that emphasizes a single, important story or issue with a large photograph (or line art) covering the entire area, a single story and photograph, or a billboard (dominant photograph with page reefers to major stories).
- DESKTOP PUBLISHING**— The use of a micro-computer, page layout software and a laser printer to generate typeset-quality graphics and text.
- DEVELOPER (CHEMICAL)**— A chemical agent used to produce a visible image on an exposed photographic layer.
- DIRECTIVE**— A type of correspondence that prescribes or establishes policy, organization, conduct, methods or procedures; requires action or sets forth information essential to the effective administration or operation of activities concerned; or contains authority or information that must be issued formally.
- DIRECTOR**— In television, the individual in charge of the studio production team. The director gives instructions to every member of the team, either directly, or in the case of the talent, indirectly.
- DISPLAY SCREEN**— Another name for a computer monitor.
- DMI**— Defense Media Institute. Provides specialized instruction for all military service personnel in the public affairs field.
- DODGING**— In still photography, a printing technique in which certain areas being exposed are temporarily shielded, thereby producing a different exposure than that used for the rest of the print.
- DOLLY**— In television, a secondary camera movement where the camera and pedestal are moved toward or away from the subject.
- DOMINANT ELEMENTS**— *See* NEWS PEG.
- DUMMY**— The process of indicating where each element will be placed on a layout sheet (sometimes called dummies or roughing in).
- ECHO**— In radio, the repetition of sound usually achieved by using a reel-to-reel tape recorder.
- ECU**— Editing control unit. In television, a piece of electronic equipment used to control the playback and edit/record videocassette recorders during videotape editing.
- EDITING CELL**— An area of a television studio devoted to videotape editing. Most editing cells in NBS detachments include a playback videocassette recorder (VCR), edit/record VCR, two television monitors, audio mixer and an editing control unit (ECU).
- EDITORIALIZING**— A violation in newswriting that occurs when the writer consciously or unconsciously expresses doubt, censure or praise in a news story or headline.

**ELECTRONIC FLASH**— In still photography, a high-voltage light source for illumination, producing a momentary flash of light of high intensity.

**ENG**— Electronic News Gathering. In television, the use of a portable video camera and portable video-cassette recorder to cover news.

**ENLARGER**— In still photography, a photographic projection printer.

**EQUALIZER**— In radio and television, a piece of equipment that alters the frequency response of an audio signal, allowing modification of specific portions of the overall signal. Equalization does not eliminate frequencies totally, but it will vary their playback levels.

**ESSENTIAL AREA**— In television, the portion of a visual that must include all the important information to ensure its reception by the viewer.

**EXPOSURE**— In still photography, a predetermined combination of shutter speed and lens aperture that allows light to pass through the lens and strike the film.

**EXTREME CLOSE-UP (ECU)**— In television and still photography, a shot where the talent or subject practically fills the screen or frame.

**EXTREME LONG SHOT (ELS)**— In television and still photography, a shot that produces a very wide field of view.

**FADE**— In radio and television, the gradual decrease or increase of the audio or video signal.

**FEATURE NEWS**— News that centers on an event or situation that stirs the emotions or imagination of an individual.

**FEATURE STORY**— A story that not only entertains, but is informative because it contains all the elements of a news story.

**FHTNC**— Fleet Home Town News Center. Administers the Fleet Home Town News Program.

**FILE, ALIBI**— A public affairs office file that contains query sheets and copies of news advisories released to the news media. Although a separate file, the news release file is also called an alibi file.

**FILE, CLIP**— A public affairs office file that contains clippings of stories that have been released and have appeared in print.

**FILE, COMMAND**— A public affairs office file that contains reference material pertaining to the

command, such as the command history and biographies of the CO, XO and C/MC.

**FILE, COMMUNITY RELATIONS**— A public affairs office file that contains the names, addresses and telephone numbers of civic leaders and community groups with which the command maintains contact.

**FILE, CORRESPONDENCE AND MEMOS**— A “public affairs office file that contains all outgoing and incoming official correspondence and memos.

**FILE, FLEET HOME TOWN NEWS**— A public affairs office file that contains a 90-day logbook or index file of each release form mailed to the Fleet Home Town News Center (FHTNC). For deployed units, this file contains copies of every release form that is part of a hold file.

**FILE, FUTURE**— A public affairs office file that contains a current listing of all events that have been scheduled or planned for the future.

**FILE, MATTERS PENDING**— A public affairs office file that maintains notes and reminders on pending ideas that may be useful for news releases, feature stories, news pegs for special events and other public affairs activities.

**FILE, MEDIA RELATIONS**— A public affairs office file that contains a listing of all media in the local area and any pertinent amplifying information.

**FILE, NEWS RELEASE**— A public affairs office file that contains the original news releases distributed to the media. The news release file is also called an alibi file.

**FILE, PHOTOGRAPHIC**— A public affairs office file that contains photographs of the ship underway or points of interest within a shore command. The photographic file also contains photographs to accompany biographies of the CO, XO and C/MC.

**FILE, PROJECT**— A public affairs office file that contains past, present and future public affairs projects involving the command.

**FILE, SPEECH**— A public affairs office file that contains copies of all prepared speeches and other presentations delivered by members of the command in connection with the speakers bureau. It also contains background materail for future speeches.

**FILM**— A light-sensitive emulsion of silver halides suspended in gelatin and coated on a transparent and

chemically neutral base, usually cellulose or polymer plastic.

**FILM SPEED**— *See* ISO.

**FILTER**— (1) In photography, a layer of colored glass, gelatin or other material used to alter the characteristics of light before it reaches the film. (2) In radio and television, an electronic circuit designed to pass only selected audio frequencies while eliminating all others.

**FILTER, COLOR COMPENSATING**— A filter used to change the overall color balance of photographic results obtained with color film and to compensate for deficiencies in the quality of the light when printing color films.

**FILTERS, KODAK WRATTEN™**— A line of filters used in black-and-white photography.

**FIVE Ws, THE**— The who, what, when, where, why (and sometimes how) that a journalist attempts to answer in writing a summary lead.

**FIXER**— A solution used to remove undeveloped silver halides from photosensitized emulsions. The fixer usually contains sodium or ammonium thiosulfate, a hardening agent, and an acid or acid salt.

**FLAG**— A newspaper device used to indicate section pages or special pages, such as editorial, sports and family pages.

**FLASH**— *See* ELECTRONIC FLASH.

**FLOOR MANAGER**— In television, a member of the studio production team who is in charge of all activities on the studio floor. The floor manager's main responsibility is to communicate instructions from the director to the talent using hand signals.

**FLOPPY DISK DRIVE**— A secondary storage device that uses a removable magnetic disk (floppy disk).

**FLUSH**— To place copy even with the column margin on either the left or right. Usually designated "flush left" or "flush right."

**FOCAL LENGTH**— The distance from the optical center of the lens to the focal plane (film plane) when the camera is focused upon an object at infinity.

**FOCAL PLANE**— The surface (plane) on which an axial image transmitted by a lens is brought to sharpest focus.

**FOCAL POINT**— A point on a newspaper page where the reader normally looks for the most important story.

**FOCUS**— To adjust the position of either the lens or focusing screen in a camera or projector to secure the sharpest possible image of the object.

**FOLIO LINE**— A newspaper's identification line on each page.

**FOLLOW-UP STORY**— A story written to update the developments of a previous story.

**FOOTCANDLE**— A basic measurement used to gauge the intensity of light.

**FORMAL BALANCE DESIGN**— A traditional front-page newspaper design pattern in which the page is divided in half vertically and each element on one side of the vertical centerline is duplicated by the same treatment of elements at the same point on the opposite side.

**FOUR-UNIT HEADING**— In radio and television, the portion of the broadcast scrip/release that contains the slugline, date, copy length and release line. It is located below the administrative information.

**FREEDOM OF INFORMATION ACT, THE**— A law established to give the public the right to access records of the executive branch of the federal government.

**FRONT LIGHTING**— In still photography, the type of lighting effect created when the sun is in back of the photographer.

**f/STOP**— A numbered diaphragm opening through which light enters the camera; f/stops are usually calibrated to change the amount of light by a factor of two times with each succeeding number.

**GAIN**— The level of amplification for video or audio signals.

**GAIN CONTROL**— *See* POT.

**GALLEY PROOF**— The initial copy of a typeset story used for proofreading and annotating typesetter errors.

**GRADUATE**— A container for liquids marked off to measure various volumes.

**GROUND GLASS**— A sheet of glass with a grained or matte (translucent) surface, such as a focusing screen or a diffusing screen.

**HALFTONE**— The technique used to reproduce photographs or drawings with tonal qualities

through the process of creating a pattern of dots or lines; the lighter the tone, the smaller and farther apart the dots.

**HANDOUT**— A term used by civilian editors to describe a standard news release.

**HARD NEWS**— A type of news story designed primarily to inform the reader, listener or viewer.

**HEAD, BANNER**— A headline that is set the full-page width at the top of a news page to draw attention to the lead story or the page in which it appears.

**HEAD, CROSSLINE**— A headline similar in appearance to a banner head, except it does not always span the full width of the page. However, the crossline head covers all the columns of the story to which it pertains.

**HEAD, FLUSH LEFT**— A two- or three-line headline with each line set flush left.

**HEAD, HAMMER**— A headline variant that is set twice the size of the main head, set flush left and is no wider than half the width of the headline area. Also known as a reverse kicker.

**HEAD, JUMP**— A headline variant designed to help the reader find a portion of a story continued from another page.

**HEAD, NOVELTY**— A headline variant that features typographical tricks, such as setting part of the head upside down, using an ornate typeface or substituting artwork as characters.

**HEAD, SIDE**— A headline that runs alongside a story.

**HEAD, SKYLINE**— A banner headline set above the flag or nameplate.

**HEAD, STANDING**— A headline variant used for regular or recurring content, such as sports and chaplains' columns. The standing head does not change from issue to issue.

**HEAD, STREAMER**— The widest and biggest multicolumn headline on a page, regardless of whether it is set the full width of the page.

**HEAD, TRIPOD**— A headline variant characterized by a single, short line of larger type set to the left of two lines of smaller type. The tripod portion (larger wording) should be twice the size of the definition or main headline.

**HEAD, WICKET**— A headline variant characterized by a short line of larger type set to the right of two

lines of smaller type. The wicket is essentially a tripod head in reverse, sans colon.

**HEADLINE**— A newspaper device that attracts the reader to a story, usually by summarizing the contents of the story (also referred to as a “head”).

**HEADLINE SCHEDULE**— A keyed record of all the headlines used in a particular newspaper and usually specifying the unit count for each.

**HOLD FILE**— A collection of Fleet Home Town News Release Forms (NAVSO 5724/1) submitted to the Fleet Home Town News Center (FHTNC) by a deploying unit. The hold file is used to process master (roster) stories, such as the deployment, mid-deployment and end of deployment stories.

**HOUSE ORGAN**— A publication printed by a business or organization that is intended primarily for internal readership.

**HUE**— In television, the actual color of light.

**HYPO**— *See* FIXER.

**INITIAL LETTER**— A large, ornate capital letter used at the beginning of a paragraph.

**INSERT EDITING**— In television, an editing mode whereby the editor may add or change video or audio separately or together without affecting the control track.

**INSTRUCTION**— A directive that contains authority or information having continuing reference value or requiring continuing action. It remains in effect for seven years or until it is superseded or otherwise canceled by the originator or higher authority, whichever occurs first.

**INTERVIEW**— A conversation between two people, one of whom seeks information from the other.

**INTERVIEW, AD-LIB**— In radio and television, an interview method that is totally unrehearsed or “off the cuff.”

**INTERVIEW, INFORMATION**— In radio and television, a type of interview designed to inform the audience.

**INTERVIEW, MAN ON THE STREET.** *See* INTERVIEW, OPINION.

**INTERVIEW, OPINION**— In radio and television, an interview whereby the thoughts or opinions of the interviewee are highlighted, such as the “man on the street” interview.

- INTERVIEW, PERSONALITY**— In radio and television, an interview that highlights the accomplishments of an individual or the position he holds.
- INTERVIEW, SCRIPTED**— In radio and television, an interview method in which all the questions and answers are prepared in advance and the interviewee(s) read from a prepared text.
- INTERVIEW, SEMI-SCRIPTED**— In radio and television, an interview method in which the interviewer researches the interviewee and subject matter, reviews possible questions with the interviewee in advance, and in some instances, rehearses the interview.
- INVERSE SQUARE LAW**— The intensity of light received at a point varies inversely as the square of the distance from the source. The law holds for relatively small sources only and is useful in calculating photographic exposures.
- INVERTED PYRAMID**— The standard straight news story form in which the writer arranges the facts in descending order of importance.
- IRIS DIAPHRAGM**— A term applied to the adjustable aperture fitted into the barrel of a photographic lens and so-called because the contraction of the aperture resembles that of the iris (pupil) in the human eye.
- ISO**— In still photography, the standard that indicates the sensitivity (film speed) of black-and-white and color film. ISO is an acronym for International Standards Organization, a federation of all national standards bodies of the world.
- JUMP CUT**— In television, an awkward or jarring transition between two camera shots.
- KELVIN**— The measurement of the color of light in degrees. Numerically, the Kelvin temperature is equal to the Centigrade temperature plus 273 degrees.
- KEYBOARD**— An input device used with computers that includes alphabetic, numeric, punctuation, symbol and control keys.
- KICKER**— An underscored line of display type placed above the main headline and to the left margin of the copy block. The kicker is one-half the size of the main headline and it is usually one-third to one-half the length of the main headline.
- LATENT IMAGE**— The image recorded by light on the light-sensitive emulsion that remains invisible until developed.
- LATITUDE**— In still photography, the amount by which a negative may be overexposed or underexposed without an appreciable loss of image quality.
- LAYOUT**— The overall pattern of the elements on a page, showing the arrangement of pictures, text and headlines.
- LEAD**— Pronounced “leed.” The first and most important paragraph of any news story. It attracts the reader and states the important facts first.
- LEAD, SUMMARY**— A news story lead that briefly summarizes the most important facts in the story.
- LEADING LINES**— A photographic technique used to direct attention toward the point of interest.
- LENS**— In still photography and television, the optical instrument or arrangement of light-refracting elements in a group; the lens is designed to collect and distribute rays of light in the formation of an image.
- LENS, WIDE ANGLE**— A lens of a shorter focal length than the standard lens, used to get more area into the picture.
- LENS, ZOOM**— A variable focal-length lens.
- LETTER, BUSINESS**— A form of correspondence generally used when writing agencies or individuals outside the Department of the Navy (DON) or Department of Defense (DoD).
- LETTER OF TRANSMITTAL**— A cover document used to submit 10 or more Fleet Home Town News Release Forms (NAVSO 5724/1).
- LETTER, STANDARD NAVAL**— Official correspondence used when writing to other naval commands or organizations within the Department of Defense (DoD).
- LIBEL**— A published (written, printed or pictured) defamation that unjustly holds a person up to ridicule, contempt, hatred or financial injury.
- LIBEL PER SE**— The more obvious and serious of the two forms of libel. Libel per se means “by itself” or “on the face of it.”
- LIBEL PER QUOD**— The least obvious of the two forms of libel. Libel per quod means “because of

circumstance” or “by means of circumstance” and is committed by inference.

**LIGHT, AVAILABLE**— *See* LIGHT, EXISTING.

**LIGHT, BOUNCE**— In still photography, an electronic flash lighting technique in which the light source is directed at the ceiling or wall and bounced back to the subject as indirect light.

**LIGHT, EXISTING**— In still photography, the light that happens to be on the scene, such as light from table, floor and ceiling lights, neon signs, windows, skylights and candles.

**LIGHT, FILL**— In television, light used to fill in and soften harsh shadows created by the key light.

**LIGHT, KEY**— In television, the main light source providing sufficient light to operate the camera. The key light serves as the reference point for all other lighting.

**LIGHT, NATURAL**— *See* LIGHT, EXISTING.

**LINE ART**— Any piece of solid color art (illustrations, rules, headlines, borders, cartoons, crossword puzzles, etc.) suitable for photographing without the use of a halftone screen.

**LIVE**— (1) In radio and television, a program that is aired in realtime (as it happens). (2) A term used to describe a piece of equipment that is turned on, such as a “live microphone.”

**LOADED QUESTION**— A question posed by an interviewer that is intended to evoke a particular response by the interviewee.

**LONG SHOT (LS)**— In television and still photography, a shot that produces a full view of the scene, including details of background as well as foreground. When the director calls for a long shot, it normally will include five or six people.

**MAKEUP**— The process of arranging pictures, headlines and news stories in a page layout to obtain maximum effectiveness.

**MASTHEAD**— A statement in a newspaper that gives the reader information about the publication, such as the name of the publisher, frequency of publication, names of staff members, and the addresses or telephone numbers of either the editorial office or publisher (or both).

**MEDIA**— Plural form of the word medium; a term used to identify all ways and means of communicating news, information and entertainment to a relatively large audience.

**MEDIA INFORMATION KIT**— A folder that contains useful background information on a ship or station or a particular news event.

**MEDIUM CLOSE-UP (MCU)**— In television and still photography, a shot that normally includes the head and shoulders of the talent or subject.

**MEDIUM LONG SHOT (MLS)**— In television and still photography, a shot between the longshot (LS) and extreme long shot (ELM).

**MICROPHONE, BIDIRECTIONAL**— A microphone with a bidirectional polar pattern, allowing it to pick up sound in two directions.

**MICROPHONE, BOOM**— A unidirectional microphone attached to a hand-held pole, allowing the microphone to remain outside of camera range.

**MICROPHONE, CONTACT**— *See* MICROPHONE, HIDDEN.

**MICROPHONE, DESK**— A stationary microphone used primarily when the talent is working from behind a desk or lectern.

**MICROPHONE, HAND**— A unidirectional microphone normally used during ENG shooting assignments and audience participation programs.

**MICROPHONE, HANGING**— A stationary microphone used when a boom microphone is impractical because of lack of space or when a large set will not permit rapid boom movement. The hanging microphone is hung from the ceiling or overhead by its cable, placing it out of normal camera range.

**MICROPHONE, HIDDEN**— A stationary microphone often used to record the sound of an object to which it is in direct contact.

**MICROPHONE, LAVALIERE**— A small unidirectional microphone used by the talent and normally clipped or taped to an article of clothing.

**MICROPHONE, LAVALIERE (DUAL REDUNDANCY)**— Two lavalier microphones attached to the same clip. One microphone is live; the other serves as an emergency backup in case the primary microphone fails.

**MICROPHONE, OMNIDIRECTIONAL**— A microphone with an omnidirectional polar pattern, allowing it to pick up sound in a 360-degree radius.

**MICROPHONE, STAND**— A stationary microphone used when the sound source is immobile and the microphone may be seen on camera.



- MICROPHONE, UNIDIRECTIONAL**— A microphone with a unidirectional polar pattern, allowing it to pick up sound from only one direction
- MICROPHONE, WIRELESS**— A standard lavalier microphone connected to a battery-powered radio transmitter that relays a radio signal to a receiver in the audio control room. Used in productions where cable-free operations are desired.
- MORE**— A direction typed at the end of a page of copy to indicate that the story does not end there — more is coming.
- MOTOR DRIVE**— A mechanical device used with a 35mm single-lens reflex (SLR) camera that fires the shutter and advances the film for a preset number of exposures.
- MUSIC BACKGROUND**— In radio, music that helps set the mood of a radio program and increases audience appeal.
- MUSIC, BRIDGE**— In radio, music that connects or “bridges” together two ideas or thoughts in a radio program.
- MUSIC, FILL**— In radio, music used to fill time at the end of a radio program.
- MUSIC, THEME**— In radio, music that helps identify the subject or character of a radio program.
- MWR**— Morale, Welfare and Recreation. Unimportant source for information regarding recreation, intramural and youth programs.
- NAMEPLATE**— The name of a newspaper in large type at the top of the front page.
- NAVSO 5724/1**— The Fleet Home Town News Release Form (Rev. 8-88). The only authorized form for all home town news releases.
- NBS**— Navy Broadcasting Service. Manages AFRTS outlets within the DON.
- NEC**— Navy Enlisted Classification. A four-digit number that indicates a special qualification earned by an individual.
- NEGATIVE**— A photographic image on film or paper in which light tones are rendered dark and dark tones appear light.
- NEWS, SOCIAL**— News that most often deals with the activities of officers and enlisted wives’ clubs, the happenings of the teen-age set, weddings and local charity events.
- NEWS, SPORTS**— News that chronicles the activities of athletic teams, discusses upcoming games and details the accomplishments of sports figures.
- NEWS, SPOT**— News obtained on the scene of the event, hence fresh, live news. Usually used to refer to unexpected events.
- NEWS ADVISORY**— An abbreviated form of a standard Navy news release intended to get the news media to cover an event themselves.
- NEWS CONFERENCE**— A meeting between an official spokesperson and news correspondents conducted primarily to provide the correspondents with information necessary to report a news event accurately, particularly a fleet exercise, special event or VIP visit. Normally, a news conference is arranged only when the news is of such magnitude that it cannot adequately be disseminated through an official Navy news release.
- NEWS PEG**— The most significant or interesting fact in a story, usually featured in the first paragraph.
- NEWS RELEASE**— *See* RELEASE and RELEASE, STANDARD NAVY NEWS.
- NEWSPAPER BROADSHEET**— *See* NEWSPAPER, FULL-FORMAT.
- NEWSPAPER, COMPACT**— *See* NEWSPAPER, MAGAZINE-FORMAT.
- NEWSPAPER, FULL-FORMAT**— A newspaper that measures 16 or 17 inches wide and 21 to 22 inches deep (a full metropolitan daily-size newspaper).
- NEWSPAPER, MAGAZINE-FORMAT**— A newspaper about half the size of a tabloid newspaper. It measures 7 to 8 inches wide and 10 to 11 inches deep.
- NEWSPAPER, TABLOID**— A newspaper that measures 10 to 12 inches wide and 14 to 18 inches deep. It is about half the size of a full-format newspaper.
- NMPS**— Navy Motion Picture Service. Provides most Navy ships with first-run movies on 1/2-inch Beta videocassettes.
- NOTICE**— A directive of a one-time nature or one that contains information or action for a brief time only. A notice usually remains in effect for less than six months, but is not permitted to remain in effect for longer than one year.

- OCCSTD**— Occupational standard A task statement that describes a minimal professional requirement in a particular rate.
- OFFSET LITHOGRAPHY**— A printing process wherein ink is applied to paper not directly from type, but from a rubber roller that has taken the impression from a photographically produced plate.
- ON CUE**— An instruction in a video news release that tells the talent to look at the television monitor in the studio and wait for the scene described in the video column to appear before continuing.
- ONE-SHOT**— In television, a shot that includes one talent.
- ORAL PUNCTUATION MARKS**— In radio, a series of diagonal lines added to copy to tell the announcer when to breathe, without disrupting the natural flow, phrasing and importance of a sentence.
- ORNAMENTS**— Any of several printer's devices, such as stars (dingbats) and dots (bullets), used to add interest and beauty to a printing job.
- OSCILLOSCOPE**— In television, a device used to display electronic signals visually and to setup and test television equipment.
- PAN**— In television, a secondary camera movement in which the camera is moved horizontally on a stationary pedestal (derived from "panorama").
- PAO**— Public affairs officer. A commissioned officer (1650 designator) trained to interpret and implement the theories and practices of Navy public affairs policy at the command level. At some smaller installations, the PAO maybe an enlisted journalist or an enlisted person from another rating.
- PAO, COLLATERAL-DUTY**— A public affairs officer without the 1650 designator who has other assignments that are considered primary duties. In most cases, a collateral-duty PAO can devote only a minimal amount of time to public affairs work
- PA REGS**— Short title for *U.S. Navy Public Affairs Policy and Regulations*, SECNAVINST 5720.44A. PA Regs provides the PAO and his staff with basic policy and regulations to carry out the public affair's and internal relations programs of the DON.
- PEDESTAL**— (1) In television, a device on which a camera is mounted. (2) A secondary camera movement where the camera is either raised or lowered on its pedestal.
- PHASING**— In radio, an effect usually used to enhance a person's voice and which is achieved when two identical audio sources are played back at slightly different start times.
- PHOTO CAPTION**— *See* CUTLINE.
- PHOTOELECTRIC TRANSDUCER**— *See* PICKUP TUBE.
- PHOTO-FLO**— *See* WETTING AGENT.
- PHOTOJOURNALISM**— A means of communication where the main emphasis is predominantly achieved through photographs.
- PICA**— Printer's unit of measure; one-sixth of an inch or 12 points.
- PICKUP TUBE**— In television, a vacuum tube housed within a television camera that changes light into electrical energy. Also known as a photoelectric transducer.
- PICTURE STORY**— A planned, organized series of related pictures that tell a story.
- PLATE**— In offset lithography, the grained zinc or aluminum sheet that carries the image to be printed.
- PLATEN**— In typewriters and printers, the hard-rubber roller against which the individual letters or printer pins strike.
- POINT**— The unit of measurement in which type sizes are designated. One point is approximately one seventy-second of an inch; 12 points equal one pica.
- POLAR PATTERN**— Inradio and television, the shape of the area around a microphone where it picks up sounds with maximum fidelity and volume.
- POSTPRODUCTION**— In radio and television, the last stage of the production process that largely involves quality control checks and final adjustments to the finished program.
- POT**— Potentiometer. In radio and television, a knob or slider used to vary the sound volume of an input to the audio console.
- PREPRODUCTION**— In radio and television, the primary production stage in which a live or taped program is planned and coordinated
- PRESREL**— Naval communications short title for a Navy press (news) release transmitted to a designated command for appropriate distribution.
- PRIMARY MOVEMENT**— In television, movement in front of the camera, usually by the talent.

- PRIVACY ACT, THE**— A law that safeguards military and civilian government employees against the invasion of personal privacy and allows them to gain access to information about themselves.
- PRODUCTION**— In radio and television, the actual execution of a live or taped program.
- PROJECTION PRINTING**— In still photography, the process of making positive prints by projecting the negative image onto photosensitive paper.
- PROJECTOR, CAROUSEL SLIDE**— A visual communication medium used to project 35mm slides.
- PROJECTOR, OPAQUE**— A visual communication medium primarily used to project graphs, photographs and other visual aids that are too small to be seen but should be shown in their actual form.
- PROJECTOR OVERHEAD TRANSPARENCY**— A visual communication medium used to project the contents of a transparent overlay (text, illustrations or both).
- PUBLIC AFFAIRS OFFICE**— The office responsible for managing all command public affairs functions, such as public information, internal information and community relations.
- QUADRANT DESIGN**— A traditional front-page newspaper design pattern where the page is divided into four quarters, and a dominant, eye-stopping element (picture or headline) is placed in each quarter so that diagonal quarters balance each other.
- QUERY**— A request for specific information by a reporter, usually made by telephone.
- QUERY SHEET**— A specially designed sheet used to document a query made by a reporter.
- QUOTE**— A portion of a story that contains the exact words of a speaker or writer.
- RACK FOCUS**— In television, the process of setting the focus on an object in the field of view. With rack focus, only the object focused upon and other objects at the same distance will remain in focus — as long as the distance between them and the camera does not change.
- RAM**— Random access memory.
- RED EYE**— In still photography, an effect that occurs in pictures of people and animals when the flash is used close to the optical axis of the lens and the subject is looking at the camera.
- REEFER**— A headline that refers the reader to an article inside the newspaper.
- REEL-TO-REEL TAPE RECORDER/REPRODUCER**— A type of tape recorder/reproducer that uses 1/4-inch magnetic tape supplied on spools. The tape, available in several reel sizes and tape lengths, must be threaded onto the machine, where it passes the tape heads at either 7.5, 15 or 30 inches per second (ips).
- RELEASE**— Information previously limited to a controlled number of persons that is made available to the general public. The release may be any material (written, printed, oral or photographic) that has been properly cleared and authorized for dissemination to the public by the Navy through any media.
- RELEASE, ADVANCE NEWS**— A type of release written to promote a scheduled special event.
- RELEASE LINE**— The portion of a news release that describes the urgency of the material, normally one of the following designations: For Immediate Release, For General Release, Do Not Use After (time and date) and Hold For Release Until (time and date).
- RELEASE NUMBER**— An identifying number assigned to a standard Navy news release.
- RELEASE, RADIO NEWS**— A type of news release designed for dissemination to radio stations and written in broadcast style.
- RELEASE, STANDARD NAVY NEWS**— A formal document, written in news style, concerning Navy activities approved for public dissemination by an authorized person. The enlisted journalist normally prepares and edits it, then the PAO, through the authority of the officer in command, approves the release.
- RELEASE, VIDEO NEWS**— A type of news release that accompanies a videotape. The release is actually a script divided into two columns; the left column is devoted completely to the video, or visual, section and the right column to the audio, or sound, section of the release.
- REMOTE**— In radio and television, a broadcast that originates outside the studio of a station.
- REVERB**— In radio, the persistence of sound until it fades away, usually achieved when a cartridge machine is used.
- REVERSE KICKER**— *See* HAMMER HEAD.

**RHETORICAL QUESTION**— A question that cannot be answered with a straight yes or no answer; it is asked mainly for effect with no answer expected

**ROUGH**— The initial manuscript of a story, normally typed double-spaced on one side of the paper only.

**ROUGH**— A thin, black line used to separate newspaper items and create boxes.

**RULE OF THIRDS**— A photographic concept where the photographer mentally divides the frame into thirds (both vertically and horizontally) and places the point of interest at one of the four intersections of these lines.

**RUN AND RETURN STORY**— A type of story processed by the Fleet Home Town News Center (FHTNC) in which the appropriate Fleet Home Town News Release Form(s) (NAVSO 5724/1) is/are returned to the submitting command after — processing.

**SADDLE STITCH**— To bind a publication along its centerfold.

**SATNET**— The AFRTS Satellite Network

**SATURATION**— In television, the actual strength of a particular color.

**SCALE**— The process of either enlarging or reducing a cropped photograph or artwork to fit in a hole on a newspaper page.

**SCALE FOCUSING**— In still photography, a calibrated scale that permits focusing a camera without the use of a range finder or ground glass.

**SCANNING**— In television, the process of registering all the elements of a video picture in sequence. During the scanning process, the television camera “encodes” the elements, then the television receiver is used to “decode” them in the proper order to recreate the original image.

**SCANNING AREA**— In television, the total area seen by the camera and reproduced on the studio monitor.

**SCREEN**— In television and still photography, a small metal screen placed in front of a lighting instrument to reduce its intensity.

**SCRIM**— In television and still photography, a piece of clear, spun glass or gauze used to diffuse and soften alight.

**SECONDARY MOVEMENTS**— In television, camera movements used to follow the primary movement

of the talent or to change or adjust picture composition

**SHOOTING SCRIPT**— A written plan for a picture story.

**SHOT**— (1) In still photography, a single exposure or photograph. (2) In television, a single scene; the continuous action occurring from the time the camera is turned on to the time it is turned off.

**SHUTTER RELEASE**— A device used to actuate a camera shutter.

**SHUTTER SPEED**— In still photography, the length of time that light is permitted to act upon film or paper as a result of the shutter having opened and closed.

**SIC**— A term used to show the reader that quoted matter contains an error, but is reproduced precisely. It is normally used within brackets: [sic].

**SIDE LIGHTING**— In still photography, the type of lighting effect used to bring out the texture of a subject.

**SILHOUETTING**— A photographic technique in which the subject is backlighted and then underexposed.

**SILVER HALIDE**— A light-sensitive silver salt, especially silver chloride or silver bromide, suspended in gelatin and used for coating photographic film, plates or papers.

**SITE**— Shipboard Information, Training and Entertainment system. Any of several closed-circuit television systems aboard authorized U.S. Navy ships and submarines.

**SLIDER**— *See* POT.

**SOUND EFFECT**— In radio and television, any noise used to enhance the spoken word.

**SPEAKERS BUREAU**— A list of speakers from within the command who talk on a variety of subjects. Administered by the command public affairs office.

**SPLICE**— The process of joining two pieces of audiotape at a predetermined location.

**SPOT ANNOUNCEMENT**— In radio, a message designed to inform the listener or make him take some action. Most spot announcements are 60 seconds or less.

**STET**— A Latin term meaning “let it stand,” used on copy or galley proofs to indicate that a marked

correction is in error and the copy should run as originally written or set.

**STILL DIGITAL PHOTOGRAPHY**— A photographic technique that allows a photographer to take pictures and store them electronically (digitally) in a specially manufactured camera. The pictures may then be processed using digital photographic software installed on a microcomputer.

**STOP BATH**— An acid solution used to arrest development by neutralizing the alkaline developer with which the photographic material is saturated as it leaves the developing bath.

**STOP DOWN**— In still photography and television, the use of a smaller aperture.

**STRINGER**— A person not assigned to a newspaper staff who contributes articles or provides information about an event.

**STROBE FLASH**— *See* ELECTRONIC FLASH.

**STYLE**— The spelling, punctuation, capitalization, abbreviation and similar mechanical aspects of grammar used in preparing copy.

**STYLEBOOK**— A compilation of rules that apply to a particular publication, including locally written policy on spelling, abbreviations, capitalization and several other areas.

**SWITCHER, AUDIO**— In television, a member of the studio production team who is responsible for operating the television audio-mixing console.

**SWITCHER, VIDEO**— In television, a member of the studio production team who is responsible for operating the video-mixing console and special effects bank.

**T/W SWITCH**— In television, the zoom servo lever that regulates the operation of a zoom lens (T for telephoto and W for wide angle).

**TALENT**— In television, the performer being photographed, such as the newscaster.

**TALLY LIGHT**— In television, the light atop the camera and inside the viewfinder that is illuminated when the shot produced by the camera is on the air.

**TAPE HEAD SEQUENCE**— The order in which the tape heads appear on a reel-to-reel tape recorder/reproducer. In most cases, the tape head sequence (from left to right) is erase, record and playback.

**TERTIARY MOVEMENT**— In television, an effect produced from a sequence of shots involving two or more cameras.

**TEST STRIP**— In still photography, a contact print produced to determine the correct exposure and contrast.

**THE ASSOCIATED PRESS**— A not-for-profit, cooperative news service that series newspapers, magazines and radio and television stations.

**THE ASSOCIATED PRESS STYLEBOOK AND LIBEL MANUAL**— The recommended guide for preparing military news.

**THIRTY (30)**— A direction typed on the last page of copy to indicate the end of the story.

**THREE-SHOT**— In television, a shot that includes three talents.

**TIE-BACK**— A newswriting device that allows the writer to refresh the reader's memory about past events related to the story being written.

**TIE-IN**— A newswriting device that provides supplementary information to the story being written.

**TILT**— In television, a secondary camera movement wherein the camera is moved vertically on a stationary pedestal.

**TONE**— In a photographic negative or print, the degree of lightness or darkness of the various parts of the image.

**TOUR**— A planned program conducted for an individual or group designed to increase public awareness and understanding of a command and its mission.

**TRACK, AUDIO**— In television, the portion of the videotape that contains the audio information. Virtually all videotape formats provide enough space for the recording of two audio tracks.

**TRACK, CONTROL**— In television, the portion of the videotape that provides the necessary foundation to control and synchronize videotape editing and playback functions.

**TRACK, TIME CODE ADDRESS**— In television, the portion of the videotape used to record cuing information for editing, such as audio or visual time/frame identification.

**TRACK, VIDEO**— The portion of the videotape that contains the video information. The video track

takes up about three-quarters of the available space on a videotape.

**TRUCK**— In television, a secondary camera movement wherein the camera is moved horizontally on its pedestal.

**TWO-SHOT**— In television, a shot that includes two talents.

**TYPEFACE**— The characteristic design of type. The following are the six main classes of type: Roman, Gothic, Text, Italics, Script and Contemporary

**TYPE FAMILIES**— Typefaces that are similar, though not exactly alike in design.

**TYPE FONT**— A complete assortment of type of one size and style.

**TYPE SERIES**— The weight, width and angle of type. When a series carries only the family name, with no adjectives indicating variations in width, weight or angle, it maybe assumed that the type is normal.

**TYPOGRAPHY**— The art of printing with type, involving the style, arrangement and appearance of the printed page.

**UNIT COUNT SYSTEM (flit-j)**— A method used to calculate the lengths of headlines by assigning numeric values to letters, numeric characters and punctuation characters.

**UNITED PRESS INTERNATIONAL**— A news service that serves newspapers, magazines and radio and television stations and sells its services to subscribing news organizations.

**VCR**— Videocassette recorder.

**VIDEO NOISE**— An effect that occurs when the video signals produced by the pickup tube of a camera are not strong enough to override the electronic interference the system usually generates.

**VIDEOCASSETTE**— A plastic container in which a videotape moves from a supply reel to a take-up reel.

**VIDEOTAPE**— A form of magnetic tape for recording pictures and sound that can be played back immediately without processing.

**VIDEOTAPE, 8mm (Hi8)**— A videotape format that is 8mm (approximately 1/3-inch) wide and housed in a plastic cassette.

**VIDEOTAPE, 1/2-INCH BETA**— A videotape format that is 1/2-inch wide and housed in a plastic cassette.

The Beta format is not compatible with VHS (the other 1/2-inch videotape format).

**VIDEOTAPE, 1/2-INCH VHS**— A videotape format that is 1/2-inch wide and housed in a plastic cassette. The VHS format is not compatible with Beta (the other 1/2-inch videotape format).

**VIDEOTAPE, 3/4-INCH U-MATIC**— A videotape format that is 3/4-inch wide and housed in a plastic cassette.

**VIEWFINDER**— A miniature black-and-white television screen through which the camera operator views the scene being photographed.

**VISUAL**— In television, a device, such as a graphic or photographic technique, used to enhance a television production.

**VU METER**— Volume units meter. In radio and television, a device used on playback units and recorders to gauge soft and loud graduations of amplitude. Correct VU meter readings are achieved when average music and voice peaks fall between 80 and 100 percent.

**WASH**— The process of using water to remove soluble chemicals from photographic layers, especially the removal of fixer to avoid subsequent fading or discoloration of the silver image.

**WAVEFORM MONITOR**— In television, a type of oscilloscope used to display a video signal graphically. Television technicians use the waveform monitor to setup and test studio television cameras.

**WEBSTER'S NEW WORLD DICTIONARY, THIRD COLLEGE EDITION**— The dictionary of first reference when spelling, style and usage questions are not covered in *The Associated Press Stylebook and Libel Manual*.

**WELCOME ABOARD BOOKLET**— A public affairs office publication that familiarizes visitors and guests with a ship or station. It normally contains a photograph of the ship (or the main gate of a shore command), CO's welcome letter, mission statement, brief history of the command and unclassified statistics and facts.

**WETTING AGENT**— A chemical added to water to reduce surface tension, thereby improving wetting characteristics and reducing the formation of water drops.

**WIDE SHOT**— *See* LONG SHOT.

**WIDOW**— A line of type at the top of a column that is less than one-half the width of the line measure of the article.

**ZOOM**— In television, a secondary camera movement similar to a dolly, but the camera does not move. It is done by zooming in or out with a zoom lens.

**ZOOM FOCUS**— In television, the process of zooming all the way in on the subject and setting the focus,

then zooming out to the focal length desired. With zoom focus, everything in the depth of field will remain in focus, including the object focused on, provided the distance between it and the camera does not change.

**ZOOM SERVO**— In television, an electronically controlled motor that regulates the operation of a zoom lens.





## APPENDIX II

# REFERENCES USED TO DEVELOP THE TRAMAN

**NOTE:** Although the following references were current when this TRAMAN was published their continued currency cannot be assured. Therefore, you need to be sure that you are studying the latest revision.

### Chapter 1

*Introduction to Journalism*, Subcourse DI 0200, U.S. Army Public Affairs Proponent Activity, Fort Benjamin Harrison, Ind., April 1987.

*Manual of Navy Enlisted Manpower and Personnel Classifications and Occupational Standards* (Volume I), NAVPERS 18068F, Bureau of Naval Personnel, Washington, D.C., April 1992.

### Chapter 2

Cappon, Rene J., *The Associated Press Guide to News Writing*, Prentice-Hall, Inc., New York, N.Y., 1991.

*Fundamentals of Newswriting*, Subcourse DI 0210, U.S. Army Public Affairs Proponent Activity, Fort Benjamin Harrison, Ind., April 1987.

*Introduction to Journalism*, Subcourse DI 0200, U.S. Army Public Affairs Proponent Activity, Fort Benjamin Harrison, Ind., April 1987.

Metz, William, *Newswriting: From Lead to "30"* (Third Edition), Prentice-Hall, Inc., Englewood Cliffs, N.J., 1991.

*Write News Stories*, Technical Lesson 1007-A, Office of the Chief of Public Affairs, Department of the Army, Washington, D.C., December 1983.

### Chapter 3

Cappon, Rene J., *The Associated Press Guide to News Writing*, Prentice-Hall, Inc., New York, N.Y., 1991.

*Feature Writing and Editorials*, SubCourse DI 0240, U.S. Army Public Affairs Proponent Activity, Fort Benjamin Harrison, Ind., September 1987.

*Introduction to Journalism*, Subcourse DI 0200, U.S. Army Public Affairs Proponent Activity, Fort Benjamin Harrison, Ind., April 1987.

Metz, William, *Newswriting: From Lead to "30"* (Third Edition), Prentice-Hall, Inc., Englewood Cliffs, N.J., 1991.

*The Associated Press Stylebook and Libel Manual*, Addison-Wesley Publishing Company, Inc., Reading, Mass., 1992.

*Write a Feature Story*, Technical Lesson 1012-A, Office of the Chief of Public Affairs, Department of the Army, Washington, D.C., January 1988.

*Write an Accident News Story*, Technical Lesson 1009-A, Office of the Chief of Public Affairs, Department of the Army, Washington, D.C., March 1983.

*Write a Sports Story*, Technical Lesson 1010-A, Office of the Chief of Public Affairs, Department of the Army, Washington, D. C., March 1988.

#### **Chapter 4**

Cappon, Rene J., *The Associated Press Guide to News Writing*, Prentice-Hall, Inc., New York, N.Y., 1991.

*Feature Writing and Editorials*, SubCourse DI 0240, U.S. Army Public Affairs Proponent Activity, Fort Benjamin Harrison, Ind., September 1987.

Metz, William, *Newswriting: From Lead to "30"* (Third Edition), Prentice-Hall, Inc., Englewood Cliffs, N.J.; 1991.

*Write a Feature Story*, Technical Lesson 1012-A, Office of the Chief of Public Affairs, Department of the Army, Washington, D.C., January 1988.

#### **Chapter 5**

Cappon, Rene J., *The Associated Press Guide to News Writing*, Prentice-Hall, Inc., New York, N.Y., 1991.

*Localize News Service Material*, Technical Lesson 1008-A, Office of the Chief of Public Affairs, Department of the Army, Washington, D.C., January 1984.

#### **Chapter 6**

*Copy Editing and Proofreading*, Subcourse DI 0220, U.S. Army Public Affairs Proponent Activity, Fort Benjamin Harrison, Ind., July 1987.

Mead, Frank S., *Handbook of Denominations in the United States* (Ninth Edition), Abingdon Press, Nashville, Tenn., 1990.

Strunk, William, Jr., and E. B. White, *The Elements of Style*, Macmillan Publishing Co., New York, N.Y., 1979.

*The Associated Press Stylebook and Libel Manual*, Addison-Wesley Publishing Company, Inc., Reading, Mass., 1992.

#### **Chapter 7**

Budd, Richard W., and Brent D. Ruben, *Beyond Media: New Approaches To Mass Communication*, Transaction Publishers, Rutgers-The State University, New Brunswick, N.J., 1991.

Cutlip, Scott M., Allen H. Center, and Glen M. Broom, *Effective Public Relations* (Sixth Edition), Prentice-Hall, Inc., Englewood Cliffs, N.J., 1985.

*Navy Public Affairs Policy and Regulations*, SECNAVINST 5720.44A, Chapter 3, "Public Information," Office of the Secretary of the Navy, Washington, D.C., June 1987.

#### **Chapter 8**

Cavuoto, James, and Stephen Beale, *Guide to Desktop Publishing*, Graphic Arts Technical Foundation, Pittsburgh, Pa., 1992.

Gilmore, Gene, *Modern Newspaper Editing* (Third Edition), Boyd & Fraser Publishing Company, San Francisco, Calif., 1983.

Illustrator Draftsman, NAVEDTRA 10472, Chapter 7, "Lettering," Naval Education and Training Program Development Center, Pensacola, Fla., 1985.

*Newspaper Design and Layout*, Subcourse DI 0260, U.S. Army Public Affairs Proponent Activity, Fort Benjamin Harrison, Ind., March 1991.

*Photojournalism Z*, Subcourse DI 0251, U.S. Army Public Affairs Proponent Activity, Fort Benjamin Harrison, Ind., July 1989.

*Soldier's Manual & Trainer's Guide (Journalist)*, Publication Number 46-46Q14-SM-TG, Headquarters, Department of the Army, Washington, D.C., August 1988.

## **Chapter 9**

Gilmore, Gene, *Modern Newspaper Editing* (Third Edition), Boyd & Fraser Publishing Company, San Francisco, Calif., 1983.

*Photojournalism Z*, Subcourse DI 0251, U.S. Army Public Affairs Proponent Activity, Fort Benjamin Harrison, Ind., July 1989.

*Writing Headlines*, Subcourse DI 0230, U.S. Army Public Affairs Proponent Activity, Fort Benjamin Harrison, Ind., March 1991.

## **Chapter 10**

*Copyright Basics (Circular 1)*, Copyright Office, Library of Congress, Washington D.C., September 1992.

*Department of the Navy Freedom of Information Act (FOIA) Program*, SECNAVINST 5720.42E, Office of the Secretary of the Navy, Washington, D.C., June 1991.

*Department of the Navy Privacy Act (PA) Program*, SECNAVINST 5211.5D, Office of the Secretary of the Navy, Washington, D.C., July 1992.

*Review Materials for Policy Violations*, Technical Lesson 1056-A, Office of the Chief of Public Affairs, Department of the Army, Washington, D.C., September 1985.

*The Associated Press Stylebook and Libel Manual*, Addison-Wesley Publishing Company, Inc., Reading, Mass., 1992.

## **Chapter 11**

CHINFO's *Digital Photographer Handbook* (Second Version), Navy Office of Information, Washington, D.C. (not dated).

*Photography (Basic)*, NAVEDTRA 12700, Naval Education and Training Program Management Support Activity, Pensacola, Fla., June 1993.

*Still Photography for Journalists*, Subcourse DI 0250, U.S. Army Public Affairs Proponent Activity, Fort Benjamin Harrison, Ind., June 1989.

## Chapter 12

*Photojournalism I*, Subcourse DI 0251, U.S. Army Public Affairs Proponent Activity, Fort Benjamin Harrison, Ind., July 1989.

*Photojournalism II*, Subcourse DI 0252, U.S. Army Public Affairs Proponent Activity, Fort Benjamin Harrison, Ind., March 1989.

*Photojournalism III*, Subcourse DI 0253, U.S. Army Public Affairs Proponent Activity, Fort Benjamin Harrison, Ind., March 1989.

## Chapter 13

*Armed Forces Radio and Television Service (AFRTS) Program Materials*, DoD Directive 5120.20-R, Appendix F, Department of Defense, Washington, D.C., January 1991.

*Basic Announcing Skills*, SubCourse DI 0320, U.S. Army Public Affairs Proponent Activity, Fort Benjamin Harrison, Ind., September 1991.

*Introduction to Broadcasting*, Subcourse DI 0300, U.S. Army Public Affairs Proponent Activity, Fort Benjamin Harrison, Ind., March 1991.

*Manage Radio Program Materials*, Technical Lesson 1123-A, U.S. Army Public Affairs Proponent Activity, Fort Benjamin Harrison, Ind., March 1989.

*Produce a Radio Feature*, Technical Lesson 1074-A, U.S. Army Public Affairs Proponent Activity, Fort Benjamin Harrison, Ind., January 1988.

Radio 11, Subcourse DI 0345, U.S. Army Public Affairs Proponent Activity, Fort Benjamin Harrison, Ind., March 1990.

*Soldier's Manual & Trainer's Guide (Broadcast Journalist)*, Publication Number 46-46R14-SM-TG, Headquarters, Department of the Army, Washington, D.C., August 1988.

Wimer, Arthur, and Dale Brix, *Workbook for Radio and TV News Editing and Writing* (Fifth Edition), Wm. C. Brown Company Publishing, Dubuque, Iowa, 1980.

Wurtzel, Alan, and Stephen R. Acker, *Television Reduction* (Third Edition), McGraw-Hill Publishing Company, New York, N.Y., 1989.

## Chapter 14 .

*Armed Forces Radio and Television Service (AFRTS) Program Materials*, DoD Directive 5120.20-R, Appendix F, Department of Defense, Washington, D.C., January 1991.

*Electronic Journalism*, Subcourse DI 0350, U.S. Army Public Affairs Proponent Activity, Fort Benjamin Harrison, Ind., March 1991.

*Navy Entertainment Movie Program Administration and Operations Manual*, NAVMILPERSCOMINST 1710.1 (Chapter 6), Naval Military Personnel Command, Washington, D.C., July 1988.

Shook, Frederick, *Television Field Production and Reporting*, Longman, Inc., White Plains, N.Y., 1989.

*Television Graphics for Broadcast Journalists*, Subcourse DI 0390, U.S. Army Public Affairs Proponent Activity, Fort Benjamin Harrison, Ind., June 1988.

Wurtzel, Alan, and Stephen R. Acker, *Television Production* (Third Edition), McGraw-Hill Publishing Company, New York, N.Y., 1989.

### **Chapter 15**

Metzler, Ken, *Creative Interviewing* (Second Edition), Prentice-Hall, Inc., Englewood Cliffs, N.J., 1989.

*Radio and Television Interviewing*, Technical Lesson 1030-A, Office of the Chief of Public Affairs, Department of the Army, Washington, D.C., March 1985.

### **Chapter 16**

*Command Histories*, OPNAVINST 5750.12E, Office of the Chief of Naval Operations, Washington, D.C., January 1990.

*Data Processing Technician* Second Class, NAVEDTRA 12511, Chapter 6, "Working with Microcomputers," Naval Education and Training Program Management Support Activity, Pensacola, Fla., July 1991.

*Department of the Navy Correspondence Manual*, SECNAVINST 5216.5C, Office of the Secretary of the Navy, Washington, D.C., August 1983.

*Illustrator Draftsman*, NAVEDTRA 10472, Chapter 16, "Audiovisual Presentation Equipment," Naval Education and Training Program Development Center, Pensacola, Fla., 1985.

*Navy Public Affairs Policy and Regulations*, SECNAVINST 5720.44A, Chapter 4, "Community Relations," Office of the Secretary of the Navy, Washington, D.C., June 1987.

*Yeoman 3*, NAVEDTRA 10298, Chapter 2, "The Office," Naval Education and Training Program Management Support Activity, Pensacola, Fla., February 1990.

### **Chapter 17**

*Instructions and Policy Concerning Fleet Home Town News Program*, SECNAVINST 5724.3, Office of the Secretary of the Navy, Washington, D.C., April 1986.



# INDEX

## A

- Abbreviations, in newswriting, 6-13
- Accident story, the, 3-17
  - casualty lists, 3-18
  - casualty name releasing policy, 3-19
  - structure of, 3-18
- Administrative areas, 16-4
- Advance stories, 5-1
  - follow-ups and rewrites, 5-1
  - rules for, 5-1
  - structure of, 5-1
- AFRTS program materials, 13-32
  - radio, 13-32
  - television, 14-41
- Attribution, 3-12
  - use in speech story, 3-12
  - use in sports story, 3-12
- Audiotape editing, 13-29
- Authority for release of Navy news, 7-7

## B

- Basic newswriting, 2-1
  - ABCS of journalism, 2-7
  - basic news elements, 2-1
  - body, the, 2-17
  - bridge, the, 2-16
  - dominant news elements, identification of, 2-3
  - inverted pyramid style, 2-11
  - language of, 2-8
  - lead, the, 2-11
  - news peg, 2-3
  - news story classes, 2-4
  - news style vs. literary English, 2-6
  - spot and created news, 2-4

## Basic newswriting—Continued

- straight news story, the, 2-10
- tie-backs, 2-16
- tie-ins, 2-17
- Biographies of command and flag officers, 16-10
- Bridge, the, 2-16
- Broadcast copy, mechanics of, 13-10
  - administrative information for, 13-11
  - body, 13-9
  - editing of, 13-13
  - leads in, 13-8
  - punctuation, 13-10
  - sentence length, 13-8
  - tenses, 13-8
- Broadcast copy, structure of, 13-6

## C

- Camera, single-lens reflex, operating, 11-6
  - activating light meter, 11-8
  - focusing, 11-7
  - holding, 11-7
  - loading, 11-6
  - setting aperture control, 11-8
  - setting film speed, 11-8
  - setting shutter speed: 11-8
  - unloading, 11-8
- Camera, single-lens reflex, 11-3
  - accessories for, 11-10
  - controls and indicators, 11-5
  - inspecting and maintaining, 11-9
  - lenses and apertures, 11-6
  - operating, 11-6
- Cameras, television, 14-1
- Capitalization, in newswriting, 6-12

- Casualty lists, in the accident story, 3-18
    - releasing policy concerning, 3-19
  - Character generators, television, 14-17
  - Command histories, 16-10
    - command and flag officer biographies, 16-10
    - command histories, 16-10
    - command presentation, 16-9
    - command welcome information, 16-9
    - files, 16-4
  - Command presentation, 16-9
  - Contact printing, 11-32
    - contact printers, 11-33
    - contact printing procedures, 11-33
  - Control room equipment, radio, 13-25
  - Copy editing, common sentence structure errors, 6-17
    - dangling modifiers, 6-18
    - errors in noun clauses, 6-20
    - errors in agreement, 6-20
    - gerunds, 6-20
    - misplaced-correlative conjunctions, 6-19
    - run-on sentences, 6-18
    - sentence fragments, 6-18
    - split infinitives, 6-19
  - Copy editing elements and usage, 6-6
    - abbreviations, 6-13
    - capitalization, 6-12
    - contradictions, 6-7
    - editorializing, 6-6
    - incompleteness, 6-7
    - military terms, 6-15
    - names, 6-8
    - numbers, 6-8
    - punctuation, 6-10
    - religious terms, 6-16
    - spelling, 6-9
    - style, 6-6
  - Copy editing message releases, 6-20
  - Copy editing procedures, 6-1
    - applying basic rules, 6-3
    - copy editing symbols chart, 6-5
    - preparing the rough, 6-2
    - using symbols, 6-2
  - Copy format, for radio, 13-3
  - Copyright, 10-9
    - availability, 10-11
    - duration, 10-15
    - government publications, use of, 10-10
    - infringement, 10-10
    - limitations, 10-10
    - notice of, 10-12
    - ownership, 10-11
    - publication, 10-12
    - publications incorporating government works, 10-13
    - registration, 10-14
    - securing of, 10-11
  - Cropping artwork in newspaper design, 8-9
  - Cutlines, 9-11
    - captions, 9-16
    - components of, 9-14
    - gathering information for, 9-13
    - layout of, 9-17
    - typography for, 9-16
- D**
- Darkroom techniques, 11-28
    - equipment, 11-29
    - photographic solutions, 11-28
  - Datelines, 9-17
  - Depth of field, in photography, 11-24
  - Desktop publishing, 8-4
    - software for, 8-5
    - strengths and weaknesses, 8-4



Developing roll film, tank method, 11-29  
Disseminating Navy news, methods of, 7-8  
    advance releases, 7-11  
    background briefings, 7-10  
    feature releases, 7-11  
    interview, 7-10  
    news advisory, 7-10  
    news conferences, 7-10  
    personal appearances, 7-11  
    spot news announcements, 7-10  
    standard Navy news release, 7-8

## **E**

Editing, videotape, 14-35  
Equipment inventory, 16-20  
Equipment maintenance, PAO office, 16-17  
Exclusive stories, 16-14  
Exposure calculation, 11-20  
    camera settings, 11-23  
    depth of field, 11-24  
    measuring exposure, 11-22  
    theory, 11-20

## **F**

Feature story, the, 3-1  
    feature writing skills, 3-2  
    news peg in, 3-2  
    personality feature, 3-7  
    structure, 3-4  
FHTNC materials, processing of, 17-4  
    deployment story, 17-9  
    FHTNC form, 17-4  
    hold file, 17-8  
    letter of transmittal, 17-7  
    photographs, 17-1  
    run and return stories, 17-11

FHTNC materials, processing of—Continued  
    sending stories by message, 17-9  
    updating hold file, 17-9  
Fleet Home Town News Center, 17-1  
    clients, 17-1  
    promoting the program, 17-4  
    story categories, 17-3  
    surveys, 17-3

Focal point, 8-18

    front page, 8-18  
    inside pages, 8-19

Follow-up story, 5-1

    reader considerations, 5-3  
    structure of, 5-3

Freedom of Information Act, the, 10-8

    agency records, 10-8  
    request format, 10-8  
    time limits, 10-9

## **G**

Galley proofs, working with, 8-29  
Gathering and disseminating Navy news, 7-1

## **H**

Headlines, 9-1

    evolution, 9-1  
    fitting method, 9-10  
    forms, 9-3  
    functions, 9-2  
    schedules for, 9-10  
    styles, 9-2  
    variants, 9-4  
    writing skills for, 9-6

Headlines and cutlines, writing of, 9-1

Headlines, 8-22

    as design element, 8-22  
    as picture story element, 8-29

Hold file, FHTNC, 17-8

disposition, 17-11

mailing of, 17-8

updating, 17-9

Home town news program, 17-1

## I

Interviewing, radio and television, 15-1

equipment considerations, 15-6

format for, 15-3

live and taped interviews, 15-3

methods of, 15-2

post production, 15-7

preparation for, 15-4

types of, 15-1

Interviews, 7-4

as means of disseminating Navy news, 7-10

interview tips, 7-5

types of, 7-4

Inverted pyramid, advantages of, 2-11

## J

Journalism, ABCs of, 2-7

## L

Layout (makeup), newspaper, 8-18

bad, opening a news story, 2-11

Libel and slander, 10-1

defenses against, 10-5

how libel is committed, 10-2

libel and the law, 10-4

responsibility for, 10-2

types of, 10-3

Lighting for photography, 11-11

electronic flash lighting, 11-14

existing light, 11-13

outdoor lighting, 11-11

Lighting, television, 14-25

## M

Magazines, articles for, 4-5

laws concerning, 4-13

researching an idea, 4-8

review and clearance of articles, 4-14

types of, 4-7

writing the story, 4-11

Magazines, 4-1

classes of, 4-1

writing for, 4-1

Makeup, newspaper, 8-18

elements of, 8-21

focal point, front page, 8-18

focal point, inside pages, 8-19

makeup lines, 8-19

Media, the, 16-12

establishing good relations with, 16-13

exclusive stories, 16-14

media information kit, 16-16

media queries, 16-14

media visits, 16-14

types, 16-12

Methods of gathering news, 7-3

interviews, 7-4

observation, 7-3

research, 7-3

telephone conversations, 7-3

Microphones, 13-29

radio, 13-29 “

television, 14-19

Military terms, in newswriting, 6-15

## N

Navy journalist, the, 1-1

major tasks and responsibilities, 1-1

Navy journalist, the—Continued

- Navy Enlisted Classifications of, 1-3
- personal traits, 1-2
- Navy news, gathering and disseminating, 7-1
- Navy news release, standard 7-8
  - numbering system, 7-10
  - timing of releases, 7-8
- News conferences, 7-10
- News elements, 2-1
  - basic, 2-1
  - identifying dominant, 2-3
- News peg, 2-3
- News sources, types of, 7-1
  - future file, 7-2
  - special contacts, 7-2
  - written communications, 7-1
- News stories, 2-1
  - classes of, 2-4
  - elements of, 2-1
  - straight, 2-10
- Newspaper design, 8-6
  - blueprint, the, 8-7
  - borders, 8-18
  - copy fitting, 8-9
  - cropping, 8-9
  - dummy, the, 8-6
  - initial letters, 8-18
  - ornaments, 8-18
  - scaling, 8-13
  - typography, 8-16
- Newspaper design concepts, 8-19
- Newspaper formats, 8-6
- Newspaper front-page patterns, 8-31
  - contemporary patterns, 8-33
  - traditional patterns, 8-33

Newspaper makeup, elements of, 8-21

- flags, 8-22
- headlines, 8-22
- masthead, 8-22
- nameplate, 8-21
- page personality, 8-25
- pictures, 8-23
- rules, 8-24

Newswriting, broadcast copy, 13-2

**O**

- Office operations, PAO, 16-1
- Offset lithography, 8-1
  - photo-offset artwork 8-2
  - photo-offset copy, 8-1

**P**

- Patterns, newspaper front page, 8-31
  - contemporary patterns, 8-33
  - traditional patterns, 8-33
- Personality feature, 3-7
- Photographic filters, 11-16
  - color photography filters, 11-18
  - filter designations, 11-17
  - purpose, 11-16
  - special-purpose filters, 11-19
  - use in black-and-white photography, 11-18
- Photographic lighting, 11-11
  - electronic flash lighting, 11-14
  - existing light, 11-13
  - outdoor lighting, 11-11
- Photographic process, 11-1
  - camera 11-1
  - film, 11-1
  - film processing, 11-1
  - photographic paper, 11-3
  - printing devices, 11-3

- Photographic subjects, directing of, 11-26
    - group pictures, 11-26
    - individual pictures, 11-26
  - Photographs, forwarding of, 12-26
  - Photography, basic, 11-1
  - Photography job orders, 11-42
  - Photography, sports, 12-24
    - coverage planning, 12-4
    - recording outline information for, 12-26
    - researching, 12-25
    - special considerations, 12-25
  - Photojournalism, basic, 12-1
    - coverage elements, 12-2
    - coverage planning, 12-4
    - history of, 12-2
    - types of news photographs, 12-3
  - Photojournalism, creating good photographs, 12-9
    - action, 12-19
    - balance, 12-15
    - camera angle, 12-14
    - compositional lines, 12-15
    - depth perception, 12-18
    - forms, 12-16
    - framing, 12-14
    - leading lines, 12-12
    - point of interest, 12-11
    - rhythm or pattern, 12-18
    - rule of thirds, 12-12
    - security and safety considerations, 12-20
    - simplicity, 12-11
  - Picture story layout, 8-25
    - body, 8-29
    - headlines, cutlines and text, 8-29
    - lead and last picture, 8-29
    - number of pictures, 8-29
    - picture direction, 8-29
  - Picture story, types of, 12-20
    - technical requirements, 12-24
  - Printing, layout and makeup, 8-1
  - Privacy Act, the, 10-7
    - releasable information, civilian, 10-7
    - releasable information, military, 10-7
  - Rejection printing, 11-36
    - enlargers, 11-36
    - making enlargement prints, 11-37
  - Proofreading, 8-29
    - galley proofs, working with, 8-29
    - proofreader's marks, 8-30
  - Proofreading symbols chart, 6-5
  - Public Affairs Office operations, 16-1
    - administrative areas, 16-4
    - Naval letter, the, 16-2
  - Punctuation in newswriting, 6-10
- Q**
- Quote-summary method, 3-10
  - Quotes, 3-10
    - use of in speech story, 3-10
    - use of in sports story, 3-15
- R**
- Radio, 13-1
    - copy format for, 13-3
    - basic elements of, 13-1
    - newswriting for, 13-2
    - radio writing techniques, 13-1
  - Radio announcing, 13-17
    - announcer responsibilities, 13-20
    - delivery, 13-18
    - preparing copy, 13-17
  - Radio control room equipment, 13-25
    - audio console, 13-25
    - audiotape cartridge machines, 13-27

Radio control room equipment—Continued  
 CD players, 13-27  
 microphones, 13-29  
 reel-to-reel tape recorder/reproducer, 13-28

Radio feature, producing, 13-21  
 basic production concepts, 13-22  
 organization, 13-24  
 recorder and reproducer setup, 13-23  
 selecting music and sound effects, 13-21  
 special effects, 13-23  
 use of the voice, 13-22

Radio interviewing, 15-1

Radio program materials, 13-32

Release authority for Navy news, 7-7

Release of information and Privacy Act, 10-7

Religious terms in newswriting, 6-16

Rewriting, principles of, 5-4  
 combining stories, 5-5  
 improving copy, 5-4  
 localizing, 5-5  
 shifting emphasis, 5-5  
 transforming informal reports, 5-5  
 updating the story, 5-4

## S

Slander and libel, 10-1

Software for desktop publishing, 8-5

Speech story, the, 3-9  
 attribution, 3-12  
 paraphrasing in, 3-9  
 quote-summary method, 3-10  
 quotes, use of, 3-10

Sports story, the, 3-13  
 sports quotes, 3-15  
 sports terminology considerations, 3-15  
 writing structure of, 3-13

Spot announcements, 13-13  
 information spot, 13-15  
 selling spot, 13-13  
 writing techniques, 13-16

Still digital photography, 11-38  
 digital camera, 11-39  
 retrieving images, 11-40

## T

Television, 14-1

Television camera, the, 14-1  
 camcorders, 14-4  
 convertible cameras, 14-4  
 electronic characteristics, 14-2  
 ENG cameras, 14-4  
 optics, 14-6  
 studio cameras, 14-3

Television interviewing, 15-1

Television lighting, 14-25  
 color temperature, 14-25  
 studio lighting, 14-25

Television microphones, 14-19  
 mobile, 14-21  
 polar patterns, 14-20  
 stationary, 14-23

Television program materials, 14-41  
 cuing AFRTS videocassettes, 14-42  
 editing AFRTS television materials, 14-42  
 handling AFRTS videocassettes, 14-42  
 Navy Motion Picture Service, 14-43  
 types of television shipments, 14-41

Television sets (stage), 14-28

Television shooting techniques, 14-29  
 framing, 14-31  
 movement, 14-33  
 shot classification, 14-30  
 talent considerations, 14-32

Television studio production team, 14-8

audio switcher, 14-12

camera operator, 14-9

director, 14-12

floor manager, 14-10

talent, 14-9

video switcher, 14-12

Television visuals, 14-14

aspect ratio, 14-14

character generators, 14-17

preparation of, 14-18

technical requirements, 14-14

types of, 14-16

Tours, 16-16

## V

Videotape editing, 14-35

basic procedures of, 14-39

formats, 14-35

modes, 14-36

process, 14-36

techniques, 14-37

tracks, 14-35

Videotape scripting, 14-39

## W

Writing, 3-1

accident stories, the, 3-1

feature story, the 3-1

speech story, the 3-9

sports story, the 3-13

---

---

# *Assignment Questions*

---

---

**Information:** The text pages that you are to study are provided at the beginning of the assignment questions.





## ASSIGNMENT 1

Textbook Assignment: "The Navy Journalist" and "Basic Newswriting," pages 1-1 through 2-18.

---

- 1-1. In the civilian world, a Navy journalist's duties most closely resemble that of what career?
1. Investigative reporter
  2. Free press journalist
  3. Public information specialist
  4. Advertising copy writer
- 1-2. The chief reason that home-town newspapers print personal items about Navy personnel is that the items contain which of the following news elements?
1. Progress
  2. Consequence
  3. Proximity
  4. Prominence
- 1-3. What two basic elements of news are best illustrated by the sentence, "The Navy Department today announced that it has developed a new long-range weapon"?
1. Immediacy and proximity
  2. Drama and immediacy
  3. Progress and immediacy
  4. Progress and proximity
- 1-4. The story that a first class petty officer has made chief, if reported in the person's home-town newspaper, contains which of the following basic elements?
1. Consequence and immediacy
  2. Proximity and progress
  3. Immediacy and oddity
  4. Emotion and consequence
- 1-5. Today, if six men from your base were to volunteer for a dangerous diving mission, a story written about them would likely contain which of the following basic elements?
1. Immediacy, proximity and suspense
  2. Prominence, consequence and conflict
  3. Consequence, immediacy and prominence
  4. Prominence, suspense and progress
- 1-6. The elements of conflict and suspense would most likely be present in a story containing which of the following facts?
1. The rescue of a treed cat
  2. An increase in pay for all rates
  3. A victory for a basketball team
  4. Three men who fought off sharks for four hours
- 1-7. The elements of sex and emotion would be present to the greatest degree in which of the following stories?
1. An English war bride finally united with her sailor husband
  2. A basketball game with a close finish
  3. A woman who wins awards for rifle marksmanship
  4. An announcement of a single's picnic at a naval base
- 1-8. The element of oddity is present in which of the following stories?
1. Twins who make chief on the same day
  2. Field day aboard ship
  3. The forced landing of a bomber
  4. The rescue of six men

- 1-9. "The newly designated Under Secretary of the Navy, John T. McNaughton, was injured today in an airplane crash near Henderson, N.C. He was flying to Washington, where, in just three days, he would have been sworn into office." A story with the preceding lead features which of the following elements?
1. Oddity and immediacy
  2. Prominence and consequence
  3. Suspense and proximity
  4. Emotion and suspense
- 1-10. Which of the following elements must be present in every good news story?
1. Sex
  2. Human interest
  3. Immediacy
  4. Prominence of suspense
- 1-11. The term "news peg" refers to what factor(s)?
1. Who, what, when, where, why and how facts
  2. The dominant news elements of the story
  3. The length of the story
  4. The situation that the story concerns
- 1-12. Which of the following subjects is NOT spot news?
1. A collision of a bus in which several members of the Navy football team were injured
  2. A transcontinental record set by a Navy jet aircraft
  3. An explosion that caused serious damage and loss of life aboard an aircraft carrier at sea
  4. A christening and launching of a new nuclear submarine
- 1-13. A story about a ball to be held to raise money for the Navy Relief Society is what type of news story?
1. Hard news
  2. Feature
  3. Sports
  4. Social
- 1-14. Off-duty military personnel volunteer to treat wounded Lebanese children. This subject is what type of story?
1. Hard news
  2. Feature
  3. Sports
  4. Social
- 1-15. A story about the new football coach at the Naval Academy in which his background and qualifications are detailed is what type of news story?
1. Hard news
  2. Feature
  3. Sports
  4. Social
- 1-16. A story about new regulations affecting military pay is what type of news story?
1. Hard news
  2. Feature
  3. Sports
  4. Social
- 1-17. A metropolitan newspaper article analyzing the consequences of a primary election is what type of news story?
1. Interpretive
  2. Financial
  3. Scientific
  4. Consumer
- 1-18. One of the major differences between literary writing style and newspaper style is that newspaper journalists try to avoid using which of the following style elements?
1. Difficult or unfamiliar words
  2. Simple language and sentences
  3. Short sentences and paragraphs
  4. Complicated ideas as subjects

- 1-19. The writer should never violate which of the following principles of newswriting?
1. Clarity
  2. Accuracy
  3. Emphasis
  4. Unity
- 1-20. Attribution is often necessary to assure which principle of newswriting?
1. Clarity
  2. Brevity
  3. Accuracy
  4. Unity
- 1-21. When writing a news release, what rule should you observe with regard to completeness and brevity?
1. Be brief although you may lack completeness
  2. Assure completeness, even though the article may be lengthy
  3. Be brief without sacrificing completeness
  4. Assure that the article is short, even though it may be incomplete
- 1-22. Writing a story so that facts are presented in some specific order is necessary for which of the following principles?
1. Coherence
  2. Emphasis
  3. Objectivity
- 1-23. By injecting personal feelings or opinions in a straight news story, you violate which of the following rules?
1. Accuracy
  2. Objectivity
  3. Clarity
  4. Unity
- 1-24. You realize that the news story you are writing is developing into two basic topics. In this case, you should follow what recommendation?
1. Continue to combine all the facts into one story
  2. Select one of the topics and discard the facts on the other topic
  3. Eliminate the story and select another unrelated topic
  4. Write the topics as two separate news stories
- 1-25. Which of the following is NOT an axiom of newswriting?
1. Avoid gobbledygook
  2. Use well-known, often-used phrases
  3. Don't use unnecessary words
  4. Use specific words
- 1-26. Which of the following sentences contains a strong, active verb?
1. The tank slowly rolled to a stop
  2. The car wash was manned by the chiefs of the air station
  3. The ship's crew ate dinner with the admiral
  4. The men in the life raft were rescued by the destroyer
- 1-27. All except which of the following are guidelines you should use when writing sentences?
1. Use a simple, declarative sentences
  2. Keep the word count consistent in sentences within the same paragraph
  3. Use compound sentences sparingly
  4. Use sentences that mirror normal, informal conversation

- 1-28. To construct a good story, a JO must take good notes. Taking good notes includes which of the following techniques?
1. Taking notes in the same sequence as they appear in the final story
  2. Taking notes that are meaningful
  3. Writing legibly
  4. Both 2 and 3 above
- 1-29. The climax is always presented in the first paragraph in which of the following style(s)?
1. Pyramid
  2. Inverted pyramid only
  3. Literary only
  4. Inverted pyramid and literary
- 1-30. Which of the following is NOT an advantage of the inverted pyramid style?
1. Maintains reader interest by saving the climax until the end
  2. Presents facts rapidly and simply
  3. Makes page layout easier
  4. Makes writing headlines easier
- 1-31. The most important aspect of a news story is based on what news element?
1. The who
  2. The when
  3. The where
  4. The news peg
- 1-32. What is the purpose of a summary lead?
1. To present the essential facts quickly
  2. To give details to satisfy reader interest
  3. To make it possible for an editor to cut the story at any point
  4. To give the story coherence
- 1-33. The rule for including the five W's and H in the lead of a news story is correctly stated in which of the following principles?
1. Only the most important of these questions should be answered in a summary lead
  2. Only when and where questions are always answered in the lead
  3. Either four or five elements of the story should be included in the lead
  4. All six questions should be answered in the lead
- 1-34. To write a good lead, you should limit its length to
1. only one paragraph
  2. fewer than 30 words
  3. not more than two sentences
  4. the fewest possible words, sentences, and paragraphs required to accomplish the objective
- 1-35. Which of the following leads answers all of the five W's?
1. Thirty minutes before he was to retire from the Navy, Clifford W. Royer, 45, a chief yeoman, was killed in an automobile accident today
  2. The Navy's highest award for bravery in action - the Navy Cross -- was pinned on Seaman Emil James at a ceremony aboard USS Greene
  3. A Navy jet pilot was killed today when his fighter crashed while on a training flight over a heavily wooded area near Glens Falls, N.Y.
  4. A veteran Navy diver, Clifford A. Patterson, 35, a chief machinist's mate, lost his life yesterday in experiments to make underwater work safer

IN ANSWERING QUESTIONS 1-36 THROUGH 1-40, SELECT FROM THE FOLLOWING LIST THE TYPE OF NOVELTY LEAD THAT FITS THE DESCRIPTION USED AS THE QUESTION.

- A. Contrast
- B. Picture
- c. Freak
- D. Punch
- E. Question
- F. Background
- G. Quotation
- H. Direct Address

1-36. Uses a play on words or poetry:

- 1. A
- 2. B
- 3. C
- 4. D

1-37. Attempts to arouse the reader's curiosity:

- 1. A
- 2. c
- 3. D
- 4. E

1-38. Tries to make the reader part of the story:

- 1. B
- 2. F
- 3. G
- 4. H

1-39. Uses colorful phrases to create an image of the surroundings or setting of a news event:

- 1. A
- 2. B
- 3. c
- 4. F

1-40. Describes the persons involved in a story:

- 1. A
- 2. 8
- 3. E
- 4. F

1-41. Which of the following types of leads is NOT a novelty lead?

- 1. Picture
- 2. Contrast
- 3. Summary
- 4. Direct address

1-42. Which of the following is a contrast lead?

- 1. From debutante to grease monkey is the goal of Navy woman Doris Barnes.
- 2. Dazed but gratefully alive, EM3 Donald Clark struggled to his feet, rubbed his arms, and admitted that 440 volts are a lot of volts.
- 3. Killer Cain strikes again!
- 4. Who would have ever thought that FT2 George Regan was timid?

1-43. Novelty leads are sometimes used for which of the following purposes?

- 1. To attempt to answer all the five W's and the H
- 2. To add variety to a newspaper story
- 3. To give a strong narrative element
- 4. To introduce a chronological order

1-44. When should you identify the subject of a news story by more than just name?

- 1. When the person is not well known to the readers
- 2. When the person is a familiar public official
- 3. When the action of the story is more important than the person involved
- 4. When the person is one of a group of persons involved in the action

- 1-45. Under what circumstances should the authority for information be given in the lead?
1. Whenever the authority is widely known
  2. When the source of information is clearly implied
  3. When it is necessary to credit the Navy with a story that deals with Navy ships and personnel
  4. When it is needed to overcome skepticism or to give support or emphasis to the information
- 1-46. When writing a lead, you should abide by all except which of the following guidelines?
1. Answer all of the five W's and H
  2. Present a summary of the story
  3. Stress the news peg
  4. Get the reader interested in reading the rest of the story
- 1-47. The bridge can be used for which of the following purposes?
1. To update the reader on events related to the story
  2. To elaborate, explain or provide authority to facts in the lead
  3. To provide a smooth transition from the lead to the body by bringing in secondary facts or filling in identification for the lead
  4. All of the above
- 1-48. When writing a second, or follow-up story about a news event, you may wish to remind the reader of the previously reported facts. You should do this with which of the following devices?
1. A background lead
  2. A tie-in
  3. A tie-back
  4. A bridge
- 1-49. To inform a reader about other events taking place that supplement the story you are writing, you should use which of the following devices?
1. A background lead
  2. A tie-in
  3. A tie-back
  4. A bridge
- 1-50. You should present the facts and details of a news story in what sequence?
1. In chronological order
  2. Ranging from greater to lesser importance
  3. With the most interesting details presented last
  4. With the story built to a climax
- 1-51. What element of newswriting, when done properly, will give you an orderly outline for the body of the story?
1. The facts themselves
  2. The notes you take
  3. The lead
  4. The bridge
- 1-52. What is the current trend in newswriting style?
1. Greater formality of language
  2. A more conversational approach and vocabulary
  3. Shorter stories
  4. More detailed coverage
- 1-53. As a guide for punctuation, spelling, capitalization and abbreviation, Navy journalists should use what publication?
1. Armed Forces News Style Guide
  2. GPO Style Manual
  3. Associated Press Stylebook and Libel Manual

1-54. Sentences for news stories should NOT have which of the following characteristics?

1. Relative brevity
2. A great many details
3. The simple declarative form
4. Only one thought per sentence

1-55. You may increase the variety that enlivens writing by use of what means?

1. Different sentence lengths
2. Familiar comparisons or similes
3. Redundant word choices

1-56. You are advising a JO striker on paragraphing stories. Which of the following suggestions would be useful?

1. Alternate paragraphs of different lengths
2. Have most paragraphs consist of two or three sentences
3. Keep your average paragraph length under 60 words
- 4\* All of the above

1-57. When selecting words for a news story, you should observe which of the following rules?

1. Avoid unnecessary words
2. Use short, common words
3. Simplify technical words
4. All of the above

IN ANSWERING QUESTIONS 1-58 THROUGH 1-60, SELECT FROM THE FOLLOWING LIST OF SENTENCES THE LETTER OF THE RESPONSE THAT BEST ANSWERS THE CHARACTERISTIC USED AS THE QUESTION.

- A. The rocket blasted off at 8:10
- B. The rocket was observed to leave its launch pad at a few minutes past 8 o'clock
- C. The rocket rose very swiftly and with a hissing roar at 8:10 in view of thousands of spectators
- D. Quick as greased lightning, the rocket ascended through the early morning sunshine and beyond the vision of the enthralled spectators

1-58. Uses a weak passive verb?

1. A
2. B
3. C
4. D

1-59. Is written in typical newspaper style?

1. A
2. B
3. c
4. D

1-60. Is inexact and uses verbs and adverbs that can be condensed into more specific wording?

1. A
2. B
3. C
4. D

## ASSIGNMENT 2

Textbook Assignment: "Writing the Feature, Speech, Sports and Accident Stories," pages 3-1 through 3-23.

---

- 2-1. What type of story especially requires creative writing skills?
1. A straight news story
  2. An accident story
  3. A feature story
  4. A speech story
- 2-2. A feature story may be effectively substituted for a straight news release under which of the following circumstances?
1. When the time factor makes a straight news story non-competitive
  2. When the human interest of the story exceeds its value as straight news
  3. When the facts of a story depend on the prominence of an event or a personality profile
  4. Each of the above
- 2-3. All except which of the following elements can turn a commonplace hobby into good material for a feature story?
1. The prominence of the individual
  2. A new development in the hobby
  3. An unusual or odd angle about the hobby
- 2-4. What is the best source of ideas for feature stories?
1. Suggestions from readers
  2. News stories in the daily papers
  3. Navy news handouts
  4. News releases from local and national organizations
- 2-5. What is the critical consideration for the feature story writer?
1. Word choice
  2. Consideration of the target audience
  3. Whether to write a straight news or feature story
  4. Permission to write the article
- 2-6. Navy journalists most often can place feature stories in commercial newspapers when they write them to emphasize which of the following topics?
1. The importance of the event
  2. New equipment
  3. Individual Navy members
  4. The background of the event
- 2-7. A fact taken from the news page may be developed into a good feature article if it is written to reflect what interest?
1. Local
  2. National
  3. International
- 2-8. What type of lead can be used in a feature story?
1. Summary only
  2. Novelty only
  3. summary or novelty
  4. Any standard news or magazine style
- 2-9. What are the parts of a feature story?
1. Body, bridge and summary
  2. Lead, body and ending
  3. Lead, bridge and body
  4. Bridge, body and ending



- 2-10. Which of the following characteristics applies to a well-written lead for a feature story?
1. It contains either a question or a quotation
  2. It always consists of more than one paragraph
  3. It always corresponds to the prominence and proximity of the subject
  4. It is appropriate for the subject and immediately arouses the reader's interest
- 2-11. To develop a good feature story on equipment, the journalist should use what technique?
1. Stress the ease of maintenance of the equipment
  2. Emphasize the complexity of the equipment
  3. Create human interest by stressing the people involved with the equipment
  4. Stress the man-hours saved by the use of the equipment
- 2-12. In a feature story, quotations should be used for what reason?
1. Because they provide variety and add authenticity
  2. Because they add color
  3. Because they are required when writing about controversial subjects
- 2-13. Which of the following suggestions for writing the body of feature stories will NOT increase reader interest?
1. Using a variety of sentence lengths
  2. Comparing scientific concepts and technology to objects with which the reader is familiar
  3. Translating technical terms into lay language
  4. Avoiding figures of speech, such as comparisons and analogies
- 2-14. For writing feature stories, you should use which of the following literary techniques when dealing with numbers?
1. Avoid numbers if possible
  2. Use comparisons to make the numbers meaningful
  3. Use generalizations instead of exact numbers
  4. Include exact numbers whenever possible
- 2-15. Which of the following training materials is the best for aspiring feature writers?
1. Books and training manuals
  2. Published feature material from other writers
  3. Their own stories and experience
- 2-16. The conclusion plays what part in the structure of a good feature story?
1. It can be readily cut from the story
  2. It sums up or highlights the story
  3. It restates the material in the lead
  4. It includes the bridge
- 2-17. The personality feature differs from other feature stories in what respect?
1. It usually pertains to only one person
  2. It arouses the reader's interest
  3. It usually requires keen, inquisitive faculty for observation
  4. It requires the imagination and curiosity of the writer

- 2-18. To write a personality feature, you may use all except which of the following techniques?
1. Including the opinions of others about the subject
  2. Telling of mannerisms and actions that are characteristic of the subject
  3. Describing the subject's personal appearance, facial expressions and dress
  4. Deliberately avoid personal descriptions that might be unflattering
- 2-19. To conduct research on a person for a personality feature, you may use which of the following sources?
1. The person themselves
  2. Printed background material
  3. Others who know the subject intimately
  4. All of the above
- 2-20. In structure, a story written about a speech most closely resembles what other story?
1. A personality feature
  2. An accident story
  3. A straight news story
  4. A feature story
- 2-21. Which of the five W's and H are usually included in the lead of the speech story?
1. Why and how
  2. When and why
  3. Who and what
  4. How and what
- 2-22. When writing a speech story, you should use all except which of the following techniques?
1. Always include a direct quote in the lead
  2. Use brief, direct quotes and scatter them throughout the story
  3. When paraphrasing, be careful not to distort the speaker's meaning
  4. Include "when" and "where" in the lead
- 2-23. Which of the following sentences is NOT correctly punctuated with quotation marks?
1. The rescued man simply said, "wow"!
  2. "Before the Vietnam Campaign," the speaker declared, "a longer training period was allowed."
  3. He inquired, "Where is the action?"
  4. "Enclose quoted material in quotation marks," the teacher stated.
- 2-24. What is an ellipsis?
1. A method of indicating that words have been deleted from a direct quotation
  2. A quotation within a quotation
  3. A paraphrase of a quotation
  4. A substitute for a parenthesis
- 2-25. When a writer ends a quote in the middle of a speaker's sentence, what end punctuation should be used?
1. A period and quotation marks
  2. Three dots only
  3. Three dots and quotation marks
  4. Four dots and quotation marks
- 2-26. At what point in the speech story must the writer identify the speaker?
1. In the title
  2. In the first paragraph only
  3. In either the first or second paragraph
  4. In the summary
- 2-27. Which of the following elements of a speaker's identity need NOT be included in a speech story?
1. Full name
  2. Full title
  3. Hometown
  4. Title

- 2-28. What is the purpose of the quote-summary method of reporting speeches?
1. To give the reader the feeling of the speech
  2. To make sure all pertinent information is included
  3. To standardize reporting throughout the industry
  4. To minimize the number of times attribution is necessary
- 2-29. Where is the natural placement for attribution of a direct quote?
1. At the beginning of the quote
  2. In the middle of the quote
  3. At the end of the quote
  4. Anywhere within the same paragraph as the quote
- 2-30. What is the best way to express attribution in a speech story?
1. By using the verb "said" alone in most quotes
  2. By using a variety of vivid verbs
  3. By adding colorful details about the speaker's gestures and tone of voice
  4. By using "said" plus appropriate descriptive verbs
- 2-31. How may the journalist add more color to a speech story?
1. By using vivid words to describe how the speaker talked
  2. By occasionally describing the speaker's gestures or hand movements
  3. By using vivid verbs to describe the speaker's emotions
  4. By using a variety of adjectives and adverbs to paraphrase the quotes
- 2-32. Which of the following is NOT a key idea for speech writing?
1. Use ellipses to handle long quotes
  2. Place the most important fact in the lead
  3. Use vivid words freely to add color
  4. Attribute all information and opinions
- 2-33. What is the usual method of reporting a sports event?
1. A feature story approach
  2. A straight news story written in the inverted pyramid style
  3. In the quote-summary style
  4. With a roundup story approach
- 2-34. What is the main difference between a sports story lead and a straight news lead?
1. The sports lead emphasizes the who and how
  2. The sports lead does not necessarily include a news peg
  3. The sports lead will not be followed by a bridge
  4. The sports lead makes no attempt to answer the five W's and H
- 2-35. Where should the game's score be included in a sports story?
1. In the lead only
  2. In the lead and bridge only
  3. Throughout the story, as needed
  4. In the lead, only if not used in the headline
- 2-36. What type of lead should you use to maintain reader interest when the reader already knows the outcome of a sports event?
1. Background information
  2. Summary
  3. Novelty

- 2-37. What information should be included in the bridge of a sports story?
1. Who won and the effect of the win on the standings
  2. When and where the event took place
  3. Who won the event and under what circumstances
  4. Where and how the win was accomplished
- 2-38. In the body of a sports story, events should be presented in what order?
1. Chronologically, skipping quiet periods
  2. By starting with the most important play
  3. From finish to start
  4. Chronologically, covering every period
- 2-39. When the key play is an error, the journalist should take what action?
1. Cover the play and fully identify the player
  2. Cover the play without full identification in the case of little league or youth activities
  3. Cover the play only if it was critical to the outcome
  4. Don't mention the play
- 2-40. To a journalist who wants to write colorful sports feature stories, which of the following tips will be helpful?
1. Feature statistical comparisons
  2. Develop a set writing style
  3. Use good sports words and bromides
  4. Acquire personal information about sports stars
- 2-41. Which of the following terminology is considered editorializing in sports writing?
1. Outstanding play
  2. Sloppy defense
  3. Referee's bad call
  4. Lucky break
- 2-42. Which of the following phrases is proper sports terminology?
1. He slammed a free throw
  2. The game was won by Boston
  3. She lobbed a grounder past the shortstop
  4. The women's soccer team clawed their way to victory last night. . .
- 2-43. Which of the following phrases is written correctly?
1. The Mole Chickens swept their division
  2. NAS Pensacola lost their last game
  3. The Battlin' Lemmings have two games left on its schedule
  4. The Fightin' Giant Lampreys signed its new head coach today
- 2-44. Which of the following story subjects should be written in sports style and normally appear on the sports page?
1. Hunting and fishing
  2. Darts
  3. Aerobics
  4. All of the above
- 2-45. What journalistic device should you use to help cover a wider variety of sports?
1. Write a sidebar for each main story
  2. Employ stringers
  3. Spend a lot of time at the gym

IN ANSWERING QUESTIONS 2-46 THROUGH 2-51, SELECT FROM COLUMN B THE SOURCE OF INFORMATION A JO SHOULD CONSULT FOR THE PURPOSE IN COLUMN A. RESPONSES MAY BE USED MORE THAN ONCE.

	<u>A. PURPOSES</u>	<u>B. SOURCES</u>
2-46.	To get a team's reaction to a disputed decision	1. MWR 2. Team members
2-47.	To learn when a canceled game will be rescheduled	3. Official score-books
2-48.	To find out what the record scoring was for any single game in a season	4. Coaches or managers
2-49.	To get a team captain's opinion on the opposition's defense	
2-50.	To learn whether a baseball star will be able to play in the next game	
2-51.	To get an explanation of a game's rules	
<hr/>		
2-52.	Accident stories must especially be written in which of the following ways?	
	1. Accurately 2. With colorful detail 3. In a sympathetic manner	
2-53.	Which of the following sequences forms the structure of an accident story?	
	1. Lead, body and ending 2. Casualty list, body and ending 3. Lead, bridge and body 4. Lead, casualty list and body	

- 2-54. Which of the following news elements is usually most important to the reader in an accident story?
1. What
  2. Who
  3. How
  4. When
- 2-55. The standard accident story structure calls for listing the names of casualties, if there are less than five, in what location?
1. The bridge
  2. The lead
  3. The body
  4. At the end of the story
- 2-56. The standard accident story structure calls for listing the names of casualties, if there are more than ten, in what location?
1. The bridge
  2. The lead
  3. The body
  4. At the end of the story
- 2-57. The casualty structure of an accident story serves all except which of the following purposes?
1. Aids the reader in rapidly identifying the dead and injured
  2. Aids the paper's composing room
  3. Aids the paper's editorial staff
  4. Aids the reader in finding stories involving casualties
- 2-58. The writer of an accident story should strive for which of the following style goals?
1. Completeness
  2. Functionality
  3. Clarity
  4. Smooth reading

- 2-59. When an accident story is released before the victims have been identified or before the next of kin have been notified, how should the writer handle this situation?
1. By stating in the space ordinarily used for names, "Names of casualties are being withheld pending notification of next of kin."
  2. By stating in the lead that names will be released later
  3. By directing the news media to hold the story until names are supplied
  4. By writing in the lead, "Names of casualties are being withheld pending notification of next of kin."
- 2-60. For the sake of clarity, what word should a JO substitute for the word "trauma"?
1. Abrasions
  2. Contusions
  3. Shock
  4. Bruises
- 2-61. When you write an account of a death, which of the following expressions is acceptable?
1. Went to his final reward
  2. Golden years
  3. Funeral services
  4. Interred
- 2-62. You can usually get the basic information about an accident involving a Navy member from which of the following sources?
1. The witnesses of the accident
  2. The casualty's division officer
  3. The personnel office "casualty report"
  4. The casualty's commanding officer
- 2-63. Since readers often unjustly blame the persons involved in an accident, in writing the story a JO should remember to observe which of the following information practices?
1. Suggest possible reasons why the Navy member was blameless
  2. Report known mitigating circumstances
  3. State that no blame should be placed
  4. Omit mention of any damaging circumstances

## ASSIGNMENT 3

Textbook Assignment: "Writing for Magazines," pages 4-1 through 4-11.

3-1. Which of the following news media tends to be overlooked by Navy journalists?

1. Newspapers
2. Magazines
3. Radio
4. Television

3-2. Magazines are especially valuable for telling the Navy's story because they have which of the following characteristics?

1. Magazines offer a ready market for any subject considered
2. Magazines are published specifically for any audience segmentation one might wish to reach
3. Magazines provide a market for stories of too narrow an interest to be published by newspapers
4. All of the above

3-3. Which of the four classes of magazines is the largest?

1. Consumer magazines
2. Business journals
3. Company publications
4. Service-oriented periodicals

3-4. What are the two types of consumer magazines?

1. Employee and sales
2. Internal and commercial enterprise
3. General interest and special interest
4. Trade and technical journals

3-5. Which of the following characteristics serve to distinguish one magazine from another?

1. Style and primary subject matter
2. Competence of the writers and lengths of articles
3. Number of subjects covered and the amount of information presented

IN ANSWERING QUESTIONS 3-6 THROUGH 3-15, SELECT FROM COLUMN B THE CATEGORY WHICH BEST DESCRIBES THE TYPE OF MAGAZINE LISTED IN COLUMN A. RESPONSES MAY BE USED MORE THAN ONCE.

	<u>A. MAGAZINE</u>	<u>B. CATEGORY</u>
3-6.	<u>Cashflow</u>	1. General
3-7.	<u>Military Living</u>	2. Special
3-8.	<u>Time</u>	3. Professional or trade
3-9.	<u>Sports Illustrated</u>	4. Commercial Enterprise
3-10.	<u>Golf Digest</u>	
3-11.	<u>Reader's Digest</u>	
3-12.	<u>Denver Living</u>	
3-13.	<u>Motor Magazine</u>	
3-14.	<u>Editor and Publisher</u>	
3-15.	<u>Life</u>	

3-16. Magazines directed at a specific group of readers are in which of the following categories?

1. General interest publications
2. Special interest publications
3. Customer magazines
4. Professional journals

- 3-17. A. Magazine aimed at skilled laborers in a particular field and addressing the work performed in that field is listed with which of the following publications?
1. Technical journals
  2. Trade journals
  3. Professional journals
  4. Special interest publications
- 3-18. Publications produced by a particular business for its employees, its customers or its stockholders are known as what category of publication?
1. Business journals
  2. Trade journals
  3. House organs
  4. Service-oriented magazines
- 3-19. A company publication designed to inspire and motivate the workers of a business is known as what category of publication?
1. Trade journal
  2. Business journal
  3. Employee magazine
  4. Sales magazine
- 3-20. What type of house organ is designed to maintain an open channel of communication between a manufacturer and an independent dealer?
1. Sales magazine
  2. Dealer magazine
  3. Stockholder magazine
  4. Technical service magazine
- 3-21. Ship and station newspapers produced by Navy journalists most closely resemble what type of company publications?
1. Employee magazines
  2. Customer magazines
  3. Sales magazines
  4. Technical service magazines
- 3-22. Service-oriented magazines may be compared with publications in which of the following categories?
1. General interest
  2. Special interest
  3. Sales magazines
  4. House organs
- 3-23. Service-oriented magazines include which of the following categories?
1. Internal magazines
  2. Trade journals
  3. Technical service magazines
  4. Business journals
- 3-24. Internal magazines include which of the following publications?
1. Magazines produced by individual naval commands
  2. Magazines produced by the Department of Defense
  3. Magazines produced by the Department of the Navy
  4. All of the above
- 3-25. All Hands differs from Sea Power in which of the following ways?
1. Its primary audience is Navy personnel
  2. Its method of financing
  3. Its availability to civilians
  4. It carries articles by Navy journalists
- 3-26. Commercial enterprise magazines are categorized with which of the following types of publications?
1. Trade journals
  2. General interest publications
  3. Special interest publications
  4. Employee magazines
- 3-27. Which of the following terms identifies a story before it is published by a magazine?
1. An article
  2. A feature
  3. A creation
  4. A manuscript



- 3-28. What factor contributes the most to creative writing?
1. Deadline pressure
  2. Ample time
  3. Subject matter
  4. Market variety

- 3-29. What major difference exists between a magazine article and a newspaper article?
1. Length
  2. Subject matter
  3. Style
  4. Punctuation rules

- 3-30. The adoption of magazine traits by newspapers was influenced most by what factor?
1. Magazine competition
  2. Television competition
  3. Educational advances of the public
  4. Increased creative writing ability of newspaper journalists

- 3-31. Which of the following magazine style elements are now used by newspapers?
1. Feature stories
  2. Glossy paper stock
  3. Looser deadlines
  4. Color pages

- 3-32. Most major newspapers deal with the challenge from the electronic media in reporting timely news events in which of the following ways?
1. They ignore, for the most part, those events reported live by radio and television
  2. They offer in-depth coverage (background information and lengthy analysis) of those events
  3. They report those news events using the upright pyramid style

- 3-33. When you write a magazine article, you should use which of the following formats?
1. Inverted pyramid
  2. Upright pyramid
  3. The one that best suits the story

---

IN ANSWERING QUESTIONS 3-34 THROUGH 3-39, SELECT FROM COLUMN B THE TYPE OF MAGAZINE ARTICLE DESCRIBED IN COLUMN A. RESPONSES MAY BE USED MORE THAN ONCE.

A. DESCRIPTIONS    B. TYPES

- |       |   |                        |
|-------|---|------------------------|
| 3-34. | It presents an inside story of conditions or problems normally unfamiliar to the average reader   | 1. Personality sketch  |
| 3-35. | Articles of this type often carry an "as told to..." byline   | 2. Personal experience |
| 3-36. | Its most noticeable characteristic is its intimate, confidential tone in which the writer seems to be personally revealing a secret to the reader | 3. Confession          |
| 3-37. | It contains sharp characterizations, vivid descriptions, dialogue, action and suspense to dramatize the facts                                     | 4. Narrative           |
| 3-38. | It is a short biography that includes an individual's achievements  |                        |
| 3-39. | The purpose of this type of article is to portray the intimate details of the character and personality of an individual                          |                        |

- 3-40. Which of the following statements characterize(s) a utility article?
1. The writing is colorful and fast-paced
  2. It is short and simple and contains the element of humor or oddity
  3. It often involves handicaps or disadvantages that a person overcomes by determination and common sense
  4. It is sometimes called the "how-to-do-it" article and it usually features expository, or explanatory, material
- 3-41. The interview article is NOT characterized by which of the following statements?
1. It requires much advance planning
  2. It presents questions and answers that offer a subject's views on a given topic
  3. Quite often it requires very little background information on the person being interviewed
  4. It requires thorough research on the person being interviewed
- 3-42. What is probably the most popular and best-selling type of short article for magazines?
1. The utility article
  2. The featurette
  3. The narrative
  4. The interview article
- 3-43. Which of the following types of magazine articles is intended solely to entertain the reader?
1. The utility article
  2. The narrative
  3. The featurette
  4. The personality sketch
- 3-44. Story ideas for magazine articles are available from which of the following sources?
1. Books and magazines
  2. The writer's observation of people and events
  3. The writer's memory of past experiences
  4. All of the above
- 3-45. You should begin all magazine articles with which of the following steps?
1. Outline the proposed article
  2. Secure a market for the story to be developed
  3. Bring the idea into sharp focus with a statement of its purpose
  4. Thoroughly research the idea to determine its feasibility
- 3-46. A writer can expect to find in the Reader's Guide to Periodical Literature which of the following items of information?
1. A listing of recently published material, indexed according to subject, title and author
  2. A list of subjects not written about within a two-week period
  3. A list of subjects reserved by individual authors for future works
  4. A listing of authors, subjects and titles of works currently being written
- 3-47. What basic knowledge can a writer obtain from the Reader's Guide to Periodical Literature?
1. The market for a particular manuscript
  2. The freshness of an idea
  3. The market value of a particular story
  4. The names and addresses of agents whose clients are being published

- 3-48. Which of the following classes of magazines is addressed by the Air University Index?
1. Consumer magazines
  2. Business journals
  3. Company publications
  4. Service-oriented magazines
- 3-49. Most magazine articles have which of the following elements in common?
1. Style similarities
  2. Identical formats
  3. Research requirements
  4. Inverted pyramid form
- 3-50. A writer should study magazines for which of the following reasons?
1. To find out the names of authors routinely published in a magazine
  2. To learn the style in which a particular magazine's publishers want articles to be written
  3. To learn the standard punctuation rules for magazines
  4. To learn what format in which a particular article should be presented
- 3-51. Preliminary research to determine consumer magazine interest in a journalist's article is conducted by which of the following parties?
1. The journalist's public affairs officer
  2. The writer of the article
  3. A regional Navy Office of Information (NAVINFO)
  4. The Magazine Writer Service in CHINFO
- 3-52. Manuscripts intended for internal magazines should be submitted to which of the following offices?
1. The NAVINFO in your region
  2. The Public Affairs Center nearest your command
  3. The editor of the internal magazine in question
  4. CHINFO
- 3-53. An outline serves which of the following functions for a magazine writer?
1. It helps in the evaluation of information
  2. It aids in the organization of information
  3. It makes writing an article easier and faster
  4. All of the above
- 3-54. Which of the following listings shows the correct order of the basic magazine article outline?
1. Purpose, plan of development, sources, market analysis and markets
  2. Market analysis, markets, sources, purpose and plan of development
  3. Purpose, market analysis, markets, sources and plan of development
  4. Purpose, market analysis, plan of development, sources and markets
- 3-55. For a Navy journalist's official work, steps 2 and 3 of the basic magazine article outline are performed by which of the following parties?
1. CHINFO
  2. District NAVINFO
  3. Area Public Affairs Center
  4. Local public affairs office
- 3-56. What part of the basic magazine article outline contains the list of pertinent facts, subtitles and anecdotes intended for the article?
1. Purpose
  2. Markets
  3. Sources
  4. Plan of development

3-57. What determines the newsworthiness of magazine articles?

1. Style
2. Format
3. The presence and intensity of the news elements
4. The application of the ABCs of journalism

3-58. Which of the following literary devices are used to give "flesh and blood" to most magazine articles?

1. Bromides
2. Allegories
3. Anecdotes
4. Alliterations

## ASSIGNMENT 4

Textbook Assignment: "Writing for Magazines" (continued), "Advanced Stories, Follow-ups and Rewrites" and "Copy Editing," pages 4-12 through 6-9.

---

IN ANSWERING QUESTIONS 4-1 THROUGH 4-11,  
SELECT FROM COLUMN B THE MAGAZINE ARTICLE  
COMPONENT IDENTIFIED IN COLUMN A.  
RESPONSES MAY BE USED MORE THAN ONCE.

<u>A. IDENTIFICATIONS</u>	<u>B. STATEMENTS</u>
4-1. A short, terse statement designed to attract the attention or arouse the curiosity of readers	1. Title 2. Lead 3. Body 4. Conclusion
4-2. A series of sentences or paragraphs intended to hold the reader's interest	
4-3. The component that neatly and succinctly ties together all the threads of an article	
4-4. Contains anecdotes, specific examples and hypothetical situations to illustrate important facts	
4-5. The most important part of a magazine article	
4-6. Intended to generate enough interest to cause the reader to read the entire article	
4-7. Conveys the tone and spirit of the material featured in the article	
4-8. May consist of as little as one paragraph in length, or may run as much as 10 percent of the entire article	

4-9. Contains a hint of the spirit and movement of the article

4-10. Sometimes employs an anecdote that typifies the main points presented in another component of the article

4-11. Indicates the central idea to be conveyed in the article

---

4-12. A Navy journalist writing magazine articles should be concerned with the possibility of violating laws in which of the following areas?

1. Copyright
2. Libel
3. Privacy invasion
4. All of the above

4-13. Permission for Navy journalists to write for non-Navy magazines is contained in which of the following publications?

1. Navy Public Affairs Regulations
2. The Associated Press Stylebook and Libel Manual
3. Navy Publications and Printing Regulations
4. Availability to the Public of Department of the Navy Records

- 4-14. Official and personal manuscripts written by Navy journalists for non-Navy publications must be reviewed and cleared if they deal with which of the following subjects?
1. Families of naval personnel
  2. Military policy
  3. Navy history
  4. Any subject, since all manuscripts must be reviewed and cleared by CHINFO
- 4-15. Manuscripts requiring review and clearance must be forwarded to which of the following offices?
1. CNO
  2. SECNAV
  3. CHINFO
  4. District NAVINFO
- 4-16. Published copies of magazine articles should be sent to which of the following offices for inclusion in Navy Department files?
1. CNO
  2. SECNAV
  3. CHINFO
  4. ASD(PA)
- 4-17. When a manuscript requires review and clearance, how many copies of the typewritten, double-spaced material should be forwarded to the reviewer?
1. One
  2. Two
  3. Three
  4. Four
- 4-18. When may a Navy journalist write for commercial publications for pay?
1. When the subject of the journalist's article is in no way related to the Navy
  2. When the writing of the article is officially assigned by the journalist's supervisor
  3. When the research and writing is done on the journalist's off-duty time, without the use of Navy facilities, equipment or personnel
- 4-19. Navy policy usually prevents which of the following desires of commercial magazine publishers from being served by Navy journalists?
1. Timely copy
  2. Preferred style
  3. Exclusive material
  4. All of the above
- 4-20. What type of story is normally written for created news only?
1. Advance
  2. Spot news
  3. Follow-up
  4. Feature
- 4-21. The first release in a series of advance news stories should contain which of the following elements?
1. All of the known facts concerning a scheduled event
  2. A few publicity puffs to whet the public's appetite
  3. An announcement that information on an upcoming event will be provided in the near future
  4. Legitimate news

4-22. The second and subsequent releases in a series of advance news stories should contain which of the following elements?

1. All of the known facts concerning a scheduled event
2. A restatement of the same information in the first release
3. Some new information not already presented
4. Only the basic nature of the event and a telephone number to call for detailed information

4-23. In reporting new developments of a previously released spot news story, you should use what method?

1. Exclusives
2. Follow-ups
3. New pegs
4. Rewrites

4-24. When writing a follow-up story, you need only consider those readers who have read the original story.

1. True
2. False

4-25. A follow-up story is written for which of the following stories?

1. Hard news
2. Advance release
3. Feature
4. All of the above

4-26. The elements of the follow-up story should be written in what order?

1. Lead, body and tie-back
2. Tie-back, body and lead
3. Tie-back, lead and body
4. Lead, tie-back and body

4-27. What element of the follow-up satisfies the requirements of readers who may or may not have read the original story?

1. The body
2. The lead
3. The tie-back

4-28. The body of a follow-up story need not be written in inverted pyramid style.

1. True
2. False

---

IN ANSWERING QUESTIONS 4-29 THROUGH 4-34, SELECT FROM COLUMN B THE REASON WHY A JOURNALIST WOULD REWRITE THE MODIFICATION IN COLUMN A. RESPONSES MAY BE USED MORE THAN ONCE.

A. MODIFICATIONS

B. REASONS

4-29. To suit the needs of different media

1. Improving copy

4-30. To include a fresh angle

2. Shifting emphasis

4-31. Finding the proper lead and placing it where it belongs

3. Updating

4-32. Converting a feature story to hard news

4. Transforming informal reports

4-33. Adding background information from the files to information phoned in by journalists in the field to complete a story

4-34. To report sports scores phoned in by MWR

---

4-35. Providing a fresh angle to a story that has been released previously is known as slanting the copy.

1. True
2. False

4-36. For use by the media in your area, you should refine and rewrite a news release from the Navy Department for what reason?

1. To update the material
2. To convert the feature story into a news story
3. To localize the general release
4. To change the emphasis

4-37. What type of lead should be used when two stories are rewritten as one?

1. Novelty
2. Hard news
3. summary
4. Combination

4-38. What is the best way for you to obtain a high percentage of coverage for one special story?

1. Distribute copies to all the media you service
2. Contact various news media directly
3. Revamp the structure of the story several ways
4. Rewrite the same story, stressing different points to meet the needs of the media you service

4-39. What is the meaning of the term "copy editing"?

1. Composing and publishing the writer's copy
2. Writing editorials from copy
3. Catching and correcting errors before they are printed and distributed
4. Catching errors in a printed publication for the purpose of correcting them in a revision

IN ANSWERING QUESTIONS 4-40 THROUGH 4-42, SELECT FROM THE FOLLOWING RESPONSES THE ONE THAT BEST INDICATES THE COPY EDITOR'S DUTY.

- 4-40.
1. To be on the alert for violations of the activity's policies
  2. To assign reporters to their areas
  3. To number all galleys
  4. To make sure that the editor okays all copy

- 4-41.
1. To make sure that reporters write their own headlines
  2. To indicate the kind and size of type to be used
  3. To review all copy for legibility
  4. To make sure that all material conforms to the style sheet of the paper

- 4-42.
1. To make all reporters revise their copy
  2. To indicate the style of type to be used
  3. To see that all facts are presented accurately
  4. To make all reporters meet their deadlines

4-43. A Navy copy editor releasing a story for civilian use need not perform which of the following duties of the civilian copy editor?

1. Checking for libelous statements
2. Writing headlines for the stories being edited
3. Adding copy for clarity or emphasis when necessary
4. Deleting unnecessary words or sentences

4-44. What function of copy editing is of prime importance to the Navy copy editor?

1. Checking for grammar and punctuation
2. reviewing for style and accuracy
3. Restoring objectivity
4. Checking for possible security violations



4-45. The procedures of a good copy editor include reading a story to (a) correct errors and make additions or deletions, (b) grasp its meaning and note the arrangement and (c) make sure the story reads smoothly. The copy editor should follow these procedures in what sequence?

1. b, a, c
2. c, b, a
3. b, c, a
4. a, b, c

4-46. A copy editor who finds an omission of essential details in a story should take what action?

1. Give the story to a second editor for revision
2. Return the story to the originating JO for rewriting
3. Read the story three times to make sure all errors are noticed and corrected
4. Rewrite the story

4-47. What is a "rough story"?

1. A new story that has been corrected by a copy editor
2. The original draft of a story
3. A story submitted by a reporter in the field over a telephone
4. A story returned from the editor to the originator for rewriting

4-48. Before submitting a story to the editor in a large office, you should type (at the top of the story) a slug line and what other information?

1. A headline
2. Your full name and date only
3. Your last name only
4. Your full name, your rate and the date

4-49. Which of the following practices is NOT a firm rule of copy editing?

1. Using a soft, black lead pencil
2. Writing legibly and clearly
3. Adding a paragraph in longhand in the margin
4. Placing copy editing symbols above or within the lines containing the errors

4-50. Editorializing means including in a news story which of the following elements?

1. Opinion of the writer
2. Contradictions
3. Personalities
4. Quotations

4-51. When, if ever, may writers refer to themselves in a news story?

1. When the writer is praising the subject of the story
2. When the writer is censuring the actions of a person in the story
3. When the writer is considered to be an authority on the subject being reported
4. Never

IN ANSWERING QUESTIONS 4-52 THROUGH 4-56, ASSUME THAT THE STATEMENTS ARE PORTIONS OF NEWS COPY. SELECT THE RESPONSE THAT INDICATES THE COPY EDITING GUIDELINE THAT IS BEING VIOLATED IN EACH STATEMENT USED AS A QUESTION.

4-52. Harrison's exemplary behavior, dedication to the Navy and performance of duties were recognized during his recent retirement ceremony. Harrison retired as a Personnelman Third Class after 20 years of service.

1. Style
2. Editorializing
3. Contradiction
4. Incompleteness

- 4-53. An outstanding performance is planned at the sports arena tonight.
1. Style
  2. Editorializing
  3. Contradiction
  4. Incompleteness
- 4-54 . Eight beautiful young ladies from the Navy community participated in the city's annual pageant.
1. Style
  2. Editorializing
  3. Contradiction
  4. Incompleteness
- 4-55. Navy pilot, James Cramer of Seattle, Wash., was killed in an air crash near Mobile, Ala. (Note: no further identification)
1. Style
  2. Editorializing
  3. Contradiction
  4. Incompleteness
- 4-56. The cafeteria is located at 3849 Pennsylvania Avenue which is a block east of the intersection of Penn. Ave. and Alabama Ave.
1. Style
  2. Editorializing
  3. Contradiction
  4. Incompleteness
- 4-57. For submitted material to be acceptable, which of the following newspaper standards must be followed?
1. Complete details on the person and circumstances central to the story must be provided
  2. The story must contain no questionable facts
  3. Correct grammar, spelling, sentence structure and punctuation must be used
  4. All of the above
- 4-58. How should the writer indicate the proper spelling of an unusual name in the rough?
1. Draw a box around it
  2. Put it in parentheses
  3. Put quote marks around it
  4. Underline it
- 4-59. When editing a story containing numbers, which of the following procedures should you follow?
1. Always apply logic to the statistics of the story
  2. Have questionable numbers verified by the writer
  3. Both 1 and 2 above
  4. Eliminate numbers as much as possible
- 4-60. Which of the following numbers is NOT acceptable in news releases?
1. 5 feet, 10 inches tall
  2. 1/2 inch
  3. 5°F
  4. Five men on the team
- 4-61. What is the most common reason every copy editor needs a dictionary?
1. To check the writer's style
  2. To check syllabication used by the writer
  3. To check the spelling of troublesome words
  4. To check grammatical usage

## ASSIGNMENT 5

Textbook Assignment: "Copy Editing" (continued) and "Gathering and Disseminating Navy News," pages 6-9 through 7-4.

---

- 5-1. Which of the following rules explains why the spelling of the word "preference" is incorrect?
1. The accent remains on the last syllable ending in a consonant preceded by a vowel in the basic word
  2. The basic word ends in a consonant preceded by a vowel; however, the last syllable of the basic word is not accented
  3. The accent has shifted away from the last syllable of the basic word, and the final consonant should not be doubled
  4. The accent remains on the syllable ending in a consonant preceded by a single vowel in the basic word
- 5-2. Which of the following words is misspelled?
1. Controler
  2. Planner
  3. Occurrence
  4. Clannish
- 5-3. Which of the following words is incorrectly spelled as a result of adding a suffix?
1. Changeable
  2. Approveal
  3. Easement
  4. Traceable
- 5-4. Which of the following words is incorrectly spelled?
1. Lateness
  2. Shapely
  3. Courageous
  4. Noticable
- 5-5. Which of the following words is incorrectly spelled as a result of adding a suffix?
1. Modification
  2. Disobeying
  3. Buoiancy
  4. Opportunities
- 5-6. Which of the following words is misspelled?
1. Activities
  2. Auxiliaries
  3. Ceremonies
  4. Phonies
- 5-7. How should you indicate voice inflection in writing?
1. By the proper use of spelling rules
  2. By the proper use of punctuation
  3. By the proper use of abbreviation rules
  4. By the proper use of capitalization
- 5-8. Punctuation is used incorrectly in which of the following instances?
1. Frank Stallings, Sr.
  2. Open the gate.
  3. 6.35 miles
  4. Jim is tall, but his brother is taller.
- 5-9. What punctuation mark separates statements of contrasts and phrases containing coronas?
1. Comma
  2. Colon
  3. Semicolon
  4. Parentheses

5-10. Which of the following sentences is improperly punctuated?

1. The envelope was addressed to Brown, Wilson & Co.
2. Among the group the question arose; Where is the building?
3. The departure time of 5:30 was too late for us.
4. The revolt occurred during the reign of Henry VIII.

5-11. Which of the following sentences contains an incorrect use of the apostrophe?

1. Isn't this the right room?
2. These are the boys' showers.
3. During the early '30s the country experienced a depression.
4. He returned the car to it's owner.

5-12. When a nickname is set apart from the name, what punctuation is used?

1. Quotation marks
2. Hyphens
3. Commas
4. Parentheses

IN ANSWERING QUESTIONS 5-13 THROUGH 5-15, SELECT FROM COLUMN B THE PUNCTUATION MARK THAT SERVES THE PURPOSE IN COLUMN A. NOT ALL RESPONSES IN COLUMN B ARE USED.

<u>A. PURPOSES</u>	<u>B. PUNCTUATION</u>
--------------------	-----------------------

5-13 . To set off letters or figures in a series	1. -- 2. ()
--	----------------

5-14. To separate figures, compound words and abbreviations and figures	3. - 4. " "
---	----------------

5-15 . To identify slang expressions and titles of books, plays, TV programs and poems	
--	--

IN ANSWERING QUESTIONS 5-16 AND 5-17, SELECT THE SENTENCE THAT CONTAINS AN ERROR IN CAPITALIZATION.

- 5-16. 1. The coastal area was devastated by Hurricane Cindy.  
2. "The devil made me do it!"  
3. The Fourth of July is on Tuesday this year.  
4. Famine is prevalent in the far east.

- 5-17. 1. The purple Heart is among the medals he wears.  
2. Texas is the Lone Star State.  
3. They are employed by the government.  
4. The Cub Scouts are going to Disney World.

5-18. You are writing a story that will contain the term "Underwater Demolition Team" several times. The term is uncommon to the general public and you plan to abbreviate it. How should you show the abbreviation when you introduce the term?

1. Underwater (U) Demolition (D) Team (T)
2. UDT (Underrater Demolition Team)
3. Underwater Demolition Team (UDT)
4. Either 2 or 3 above

IN ANSWERING QUESTIONS 5-19 THROUGH 5-22, SELECT THE PHRASE OR SENTENCE THAT CONTAINS THE INCORRECT USE OF ABBREVIATIONS IN NEWSWRITING.

- 5-19. 1. 10:00 o'clock CST  
2. The Washington Redskins vs. Dallas Cowboys  
3. Jones & Son  
4. 1621 Grover Rd.

- 5-20. 1. Zion National Park, Utah  
2. Yellowstone National Park, Ida.  
3. We visited the United Nations Building.  
4. Clark Field is near Manila, Luzon, R.P.

- 5-21. 1. Frank R. Philips, the Prof., presented the lecture.  
 2. Aubrey Crossland, B.S., M.S., is the head of the department.  
 3. He enlisted Sept. 18, 1940, and was discharged in September 1945.  
 4. His home is in Mount Clemens, Mich.

- 5-22. 1. Ft. Worth, Texas  
 2. Fort Bliss, Texas  
 3. 155 mm howitzer  
 4. St. Louis, Mo.

5-23. Of the following examples, which abbreviation is NOT correct in newswriting?

1. Johnson & Johnson
2. 513 Clemson Dr.
3. 201 Baker St. NW
4. St. Paul, Minn.

5-24. What is the civilian editor's major complaint against military journalism?

1. The incorrect use of punctuation
2. Excessive title and organization abbreviation
3. Articles that lack completeness
4. Excessive contradictions in the articles

5-25. Which of the following professional identifications is properly written?

1. Dr. (Army Captain) Henry Philips
2. Navy Chaplain John Murphy, Lt.
3. Navy Nurse Lt. Helen Brown
4. Navy Commander (Dr.) Alice Robinson

5-26. Which of the following references to members of the clergy is NOT a correctly written title?

1. The Rev. Betty Jones, D.D.
2. The Rev. Smith
3. The Rev. Dr. John A. Parker
4. The Rev. Mr. Thomas

IN ANSWERING QUESTIONS 5-27 THROUGH 5-30, SELECT FROM COLUMN B THE CLERGYMAN TITLE THAT CORRESPONDS TO THE FAITH IN COLUMN A.

	<u>A. FAITH</u>	<u>B. CLERGY TITLE</u>
5-27.	Latter-Day Saints	1. The Most Rev. Frank Porter
5-28.	Christian Science	2. Reader Harvey Whelchel
5-29.	Methodist	3. Pastor Floyd
5-30.	Mormon	4. President Claude Jones

---

5-31. Unlike regular Navy messages, press release messages are usually transmitted in news style.

1. True
2. False

5-32. Which of the following headings properly identifies a message news release?

1. PRESS RELEASE 0945Z 15 AUG 93
2. PRESREL 0945Z 15 AUG 93
3. PRESREL 150945Z AUG 93
4. 150945Z AUG 93 PRESS RELEASE

5-33. Which of the following date times does NOT indicate local time in an area outside of Greenwich Mean Time?

1. 111300Z
2. 171545U
3. 080730R
4. 231423K

5-34. When may a news message with no special instructions to the contrary be printed?

1. Immediately
2. After an interval of 24 hours
3. When security clearance is received
4. Simultaneously with other press releases

- 5-35. What must you do to a message press release before releasing it to the news media?
1. Add color to the story by inserting adjectives and adverbs
  2. Type the information in the proper format
  3. Copy edit and duplicate it
  4. Grammatically complete many of the sentences
- 5-36. When you copy edit a message press release, what assumption must you make?
1. That the release needs no correction in punctuation
  2. That all letters are lowercase and you must indicate capital letters
  3. That paragraphs have been properly indented
  4. That no capitalization is necessary since the whole release is in capital letters
- 5-37. A run-on sentence may be defined in what way?
1. As a sentence that contains too many verbs
  2. As a sentence that is too long or drawn out
  3. As two or more sentences that are punctuated to appear as one sentence
  4. As a single thought evolved into two or more sentences by improper punctuation
- 5-38. Which of the following examples is a sentence fragment?
1. He ran the ship aground.
  2. The boy and his father went fishing.
  3. As she ran up the street, she screamed.
  4. Being unfamiliar with the area, what he would do.

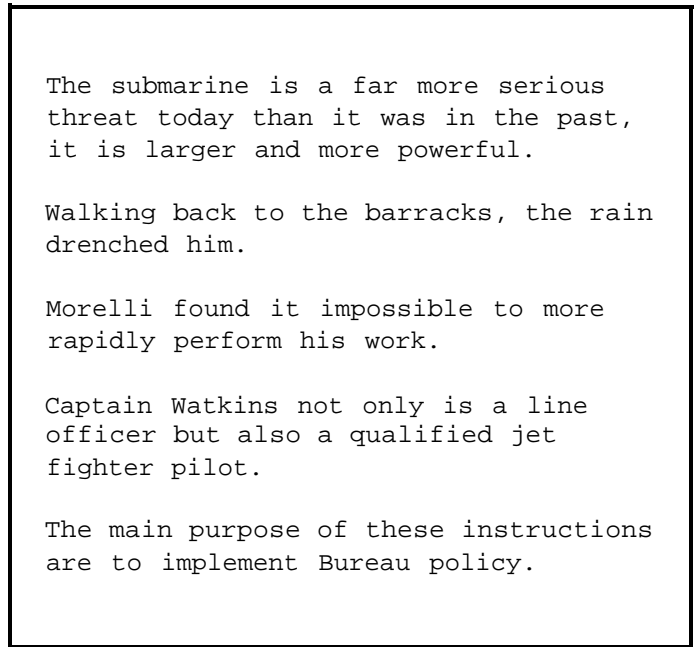

Figure 5-A.

IN ANSWERING QUESTIONS 5-39 THROUGH 5-43, REFER TO FIGURE 5-A.

- 5-39. How should the run-on sentence be reworded?
1. Being larger and more powerful, the submarine is a far more serious threat today than it was in the past.
  2. The rain was drenching him while walking back to the barracks.
  3. It was found impossible for Morelli to more rapidly perform his work.
  4. Captain Watkins is a line officer not only but also a qualified jet fighter pilot.

- 5-40. How should the sentence that contains the dangling participle be reworded?
1. Today's submarine is a far more serious threat, it is larger and more powerful than it was in the past.
  2. Walking back to the barracks, he was drenched by the rain.
  3. It was impossible, Morelli found, to more rapidly perform his work.
  4. Captain Watkins not only is a line officer but a qualified jet fighter pilot.

- 5-41. How should you reword the sentence that contains a misplaced correlative conjunction?
1. The submarine today is a far more serious threat than it was in the past, it is larger and more powerful than before.
  2. In walking back to the barracks the rain drenched him.
  3. The work was impossible to more rapidly perform, Morelli found.
  4. Captain Watkins is not only a line officer but also a qualified jet fighter pilot.

- 5-42. How should you revise the sentence that contains a split infinitive?
1. Submarines are far more serious threats today, they are larger and more powerful than in the past.
  2. The rain drenched him in walking back to the barracks.
  3. Morelli found it impossible to perform his work more rapidly.
  4. Implementation of Bureau policy is the main purpose of these instructions.

- 5-43. Which of the following revisions corrects the grammatical error in the last sentence?
1. The main purpose of these instructions are the implementation of Bureau policy.
  2. The main purpose of these instructions is to implement Bureau policy.
  3. The main purpose of these instructions are to implement Bureau policies.
  4. To implement Bureau policy are the main purpose of these instructions.

- 5-44. Where should correlative conjunctions be positioned in a sentence?
1. Immediately following the words they connect
  2. Immediately ahead of the words they connect
  3. As far as possible from the words they connect
  4. Between the words they connect

IN ANSWERING QUESTIONS 5-45 THROUGH 5-49, SELECT THE RESPONSE OF THE TYPE OF GRAMMATICAL ERROR DEMONSTRATED IN THE INFORMATION USED AS THE QUESTION.

- 5-45. Either complete the form in this room or in your office and return it to me.
1. Misplaced correlative conjunction
  2. Misplaced prepositional phrase
  3. Misplaced relative clause
  4. Dangling participle phrase

- 5-46. Judge Harter asked for the submission of briefs before handing down a decision on the alleged criminal actions which were prepared by the opposing officers.
1. Misplaced correlative conjunction
  2. Misplaced prepositional phrase
  3. Misplaced relative clause
  4. Dangling participle phrase
- 5-47. He was not only courteous to rich customers but also to poor ones.
1. Misplaced correlative conjunction
  2. Misplaced prepositional phrase
  3. Misplaced relative clause
  4. Dangling participle phrase
- 5-48. Skidding off the road, he was hit by a truck.
1. Misplaced correlative conjunction
  2. Misplaced prepositional phrase
  3. Misplaced relative clause
  4. Dangling participle phrase
- 5-49. With large, sharp teeth, he fought a shark.
1. Misplaced correlative conjunction
  2. Misplaced prepositional phrase
  3. Misplaced relative clause
  4. Dangling participle phrase
- 5-50. Which of the following sentences contains a split infinitive?
1. Their main objective was to completely destroy the target
  2. The purpose of the maneuver was to destroy the target completely
  3. To understand thoroughly his book you must refer to the dictionary constantly
  4. Either we will go to the races or to the ball game
- 5-51. What is the definition of a gerund?
1. A noun or pronoun used as a verb
  2. A verb or adverb used as a noun clause
  3. A participle used as a verb
  4. A verb used as a noun
- 5-52. Which of the following sentences illustrates the proper case for the subject of a gerund?
1. The captain knew of him securing the life boat.
  2. The officer did not approve of you firing the pistol.
  3. The division officer approved his taking special liberty.
  4. They were not aware of him meeting the selection board today.
- 5-53. Which of the following sentences does NOT illustrate the cases of pronouns introducing noun clauses?
1. Whoever wins the preliminary heat will represent us in the final race.
  2. The student who makes the best poster will be honored in the assembly.
  3. The commanding officer will give special recognition to whomever wins the race.
  4. The duty officer wishes to know who has the watch.



IN ANSWERING QUESTIONS 5-54 THROUGH 5-60, SELECT FROM COLUMN B THE PRIMARY SOURCE OF NAVY NEWS THAT WILL PROVIDE THE INFORMATION LISTED IN COLUMN A. RESPONSES MAY BE USED MORE THAN ONCE.

<u>A. INFORMATION</u>	<u>B. SOURCES</u>
5-54. Search and rescue operations	1. Future file operations
5-55. Armed Forces Day parade	2. Special contacts
5-56. Adoption of a beneficial suggestion submitted by a seaman at your command	3. Messages, directives and official correspondence
5-57. Publicity material on new ship construction	
5-58. New equipment being tested at your base	
5-59. A former child TV star, now in the Navy, reports for duty at your base	
5-60. Changes in Navy retirement benefits	
5-61. What factor should you consider when using information in naval messages, directives and official correspondence as news stories?	
	1. Length of the article
	2. Reader appeal
	3. Security
	4. Authenticity
5-62. You may obtain a good flow of news tips by which of the following ways ?	
	1. Trying to develop as many contacts as possible
	2. Talking about your job with your friends
	3. Cultivating good relationships with the senior officers in your command
	4. All of the above

- 5-63. Public affairs office personnel will find it useful to keep track of future events and to schedule publicity releases by use of which of the following methods?
1. Assigning one person in the office to write created news stories
  2. Using a tickler system
  3. Scheduling the publicity story for each event on a certain date
  4. Each of the above
- 5-64. What source of Navy news is usually collected as created news?
1. The future file
  2. Official contacts
  3. Unofficial contacts
  4. Messages, directives and official correspondence
- 5-65. In what method of gathering news should you attempt to get more information than is actually needed?
1. Research
  2. Interview
  3. Telephone conversation
  4. Observation
- 5-66. You should avoid using the telephone to request information under what circumstance?
1. When a third person can overhear the conversation
  2. When your information source is a very busy person
  3. When the person called can be easily reached in other ways
  4. When the subject of your conversation may touch upon classified matters
- 5-67. In writing a feature story, you should use what method of gathering news to give depth to the story?
1. Interview
  2. Research
  3. Observation
  4. Telephone conversation

5-68. What method of getting information for news stories is the most frequently used?

1. Research
2. Observation
3. Interviewing by phone or in person
4. Reading Navy messages and directives

## ASSIGNMENT 6

Textbook Assignment: "Gathering and Disseminating Navy News" (continued) and "Printing, Layout and Makeup," pages 7-4 through 8-10.

---

- 6-1. An interview feature story, unlike an interview-based news story, emphasizes which of the following factors?
1. The central news event
  2. The writer's opinions and reactions about an event
  3. The accomplishments or views of a group or of an individual
  4. Information about an occurrence
- 6-2. A tip that arouses the curiosity of the writer and becomes a major news story can often result from what type of interview?
1. News
  2. Casual
  3. Personality
  4. Prepared question
- 6-3. To illuminate, expand and add depth to an original news release of importance to a community, you should use what type of interview?
1. News
  2. Casual
  3. Personality
  4. Prepared question
- 6-4. If you are unable to arrange a direct face-to-face interview, you should rely on what type of interview?
1. news
  2. Casual
  3. Personality
  4. Prepared question
- 6-5. A feature story that delineates the character, appearance and mannerisms of an individual is best written after the writer has conducted what type of interview?
1. News
  2. Casual
  3. Personality
  4. Prepared question
- 6-6. An event or development of current and immediate interest would be the subject of what type of interview?
1. News
  2. Casual
  3. Personality
  4. Prepared question
- 6-7. Which of the following types of interviews is a modified version of the news interview?
1. Symposium
  2. Telephone
  3. Prepared question
  4. News conference
- 6-8. A symposium interview is used for which of the following purposes?
1. Getting authoritative opinion
  2. Sampling the opinions of a number of persons
  3. Getting background material for a created news story
  4. Writing a personality profile

- 6-9. A new officer in charge has reported for duty. Before interviewing the officer for a feature story in the station newspaper, you should take which of the following actions?
1. Talk to the officer's family for background color
  2. Study all biographical data on the subject so you can demonstrate your knowledge of him or her
  3. Interview shipmates who served with the officer before
- 6-10. During an interview, the subject mentions an angle to the story that you hadn't known about. What action should you take?
1. Politely listen and write down the information, but don't use it in the story
  2. Request that the interviewee remain on the subject
  3. Record the information and ask any appropriate follow-up questions
- 6-11. At an interview, you are using a portable tape recorder equipped with a separate microphone. How should you handle the microphone?
1. Hand it to the subject to obtain the best recording
  2. Hold it yourself, directly in front of the subject's mouth
  3. Hold it yourself, but out of the way
  4. Either 2 or 3 above, depending on the subject's wishes
- 6-12. During an interview, the subject mentions a family member with an unusual name. How should you handle the spelling of the name?
1. Give it your best guess
  2. Ask the subject to spell it for you
  3. Don't use the name in the story
  4. After the interview, call the family member for a correct spelling
- 6-13. You are seeking information about an automobile accident and the eyewitness you have located refuses to answer your questions. What approach should you take first to get the story?
1. Threaten the witness with court action
  2. Seek the information elsewhere
  3. Try persuading the witness to change his or her mind
  4. Politely inform the witness about the Freedom of Information Act
- 6-14. A naval station's public affairs officer may be authorized to release Navy news of purely local interest.
1. True
  2. False
- 6-15. news releases must be approved by an authority higher than a commanding officer for which of the following subjects?
1. Reductions in naval personnel at a naval station
  2. Names of civilian casualties aboard a Navy ship
  3. Routine movement of a naval ship from one naval station in the United States to another
  4. All of the above
- 6-16. Complete details on the proper release of all types of news is covered in which of the following publications?
1. Navy Regulations
  2. Navy Public Affairs Regulations
  3. Freedom of Information Act
  4. All of the above
- 6-17. To disseminate news, Navy journalists use what method most often?
1. Interviews
  2. Background briefing
  3. Spot news announcements
  4. Standard Navy news releases

● QUESTIONS 6-19 THROUGH 6-23 PERTAIN TO THE STANDARD NAVY NEWS RELEASE FORMAT.

- 6-18. Which of the following information must appear on every release?
1. Name and address of originating command
  2. Point of contact for further information
  3. Office telephone numbers
  4. All of the above
- 6-19. How should copy be typed on the release form(s)?
1. Single spaced, one side per page
  2. Single spaced, on both sides of the paper, if needed
  3. Double spaced, one side per page
  4. Double spaced, on both sides of the paper, if needed
- 6-20. The majority of standard Navy news releases are of what type?
1. Hold For Release
  2. For Immediate Release
  3. Background Information Only
- 6-21. If a Navy story is for immediate release, how is that information conveyed to the news media receiving the release?
1. The words "FOR IMMEDIATE RELEASE" are typed in the upper right-hand corner of the release
  2. The words "FOR IMMEDIATE RELEASE" are typed near the left margin of the release, preceding the story
  3. The date and time a story may be released are included in the cover letters to the media
  4. News media representatives are informed by telephone when the releases can be printed
- 6-22. Which of the following news items prepared on 1 July might you justify issuing on a "HOLD FOR RELEASE" basis?
1. A ship to be commissioned on 21 July
  2. Text of a speech to be given by the CO on 4 July
  3. Naval station general public visit schedule for 3, 4 and 5 July
  4. Story of an accident that does not include names of casualties
- 6-23. Local newsmen gain which of the following advantages by receiving a "HOLD FOR RELEASE" future speech of a Navy official?
1. They need to record only a part of the speech
  2. They would not have to take notes during the speech
  3. They may set their story in type ahead of time, then only modify any changes made in the speech
  4. Each of the above
- 6-24. What is the purpose of a release numbering system?
1. To simplify identification of each release
  2. To expedite getting spot news released
  3. To make workload scheduling in the office more efficient
  4. To keep track of how many stories are written monthly
- 6-25. You are preparing a news release for media A, B and C. It is the first release made by your office in calendar year 1994. What release number should you assign to each release?
1. 1a-94 to A, 1b-94 to B, 1c-94 to c
  2. 1-94 to A, 2-94 to B, 3-94 to C
  3. 1-94 to all three
  4. 94-1a to A, 94-2b to B, 94-3c to c

- 6-26. A news conference should be called for which of the following purposes?
1. Requesting media to submit questions in advance
  2. Squelching disclosures that the Navy wants to hide
  3. Increasing the prestige of the information to be released
  4. Releasing information that cannot be sufficiently covered by any other means
- 6-27. To release information without identifying the individual as the source of the news, the Navy uses what method?
1. Symposium interviews
  2. Background briefings
  3. News conferences
  4. written releases
- 6-28. Immediacy is of the greatest importance in what type(s) of release(s)?
1. Spot news announcements
  2. Feature releases only
  3. Advance releases only
  4. Feature and advance releases
- 6-29. Photographs are often included with what type(s) of release(s)?
1. Spot news announcements
  2. Feature releases only
  3. Advance releases only
  4. Feature and advance releases
- 6-30. What type(s) of release is/are newsworthy only when it contains a great deal of general human interest?
1. Spot news announcements
  2. Feature releases only
  3. Advance releases only
  4. Feature and advance releases
- 6-31. Invitations, background material and programs are often issued for future events and accompany what type(s) of release(s)?
1. Spot news announcements
  2. Feature releases only
  3. Advance releases only
  4. Feature and advance releases
- 6-32. A follow-up story usually supplements what type(s) of release(s)?
1. Spot news announcement
  2. Feature releases only
  3. Advance releases only
  4. Feature and advance releases
- 6-33. An interview as a method of disseminating news differs from a news conference in which of the following ways?
1. It involves communication of information from a spokesperson to only one reporter
  2. It is limited to a shorter period of time
  3. It usually produces more information for the reporter
- 6-34. An unexpected and important event occurs at your command. The local radio station and other media call for information. Assuming the news is not classified, the PAO should respond in which of the following ways?
1. Answer all questions of each caller
  2. Write and release a news story addressing the event as soon as possible
  3. Invite representatives from all news media in the area to attend a news conference
  4. Depending on the circumstances, any one of the above responses may be used

- 6-35. Your PAO has just finished a speech at a local Rotary club meeting. As he is leaving, club members comment on the speech and ask his opinion on another military matter not related to the speech. If he were to respond to the questions, what method of news dissemination, if any, would he or she be using?
1. Background briefing
  2. Casual interview
  3. Personal appearance
  4. None
- 6-36. What is the most common printing process used today to produce civilian and Navy newspapers?
1. Mimeograph
  2. Offset lithography
  3. Letterpress
  4. Silk screening
- 6-37. Which of the following is/are a component of a desktop publishing system?
1. Personal computer
  2. Page layout software
  3. Laser printer
  4. All of the above
- 6-38. Which of the following printing methods is the cheapest and quickest?
1. Desktop publishing
  2. Mimeograph
  3. Offset lithography
  4. Silk screening
- 6-39. Which of the following is NOT an advantage of desktop publishing?
1. A dramatic cut in cost
  2. Standardized page layouts
  3. Less space occupied
  4. Less disruptive last minute changes
- 6-40. Which of the following is/are an advantage of desktop publishing?
1. Faster turnaround time
  2. Eliminates the need to work with publishers on initial paste-up
  3. Both 1 and 2 above
  4. Eliminates the need to work with reporters and copy editors
- 6-41. Peripheral equipment that will add greatly to the flexibility of your desktop publishing system includes all except which of the following?
1. Mouse
  2. Scanner
  3. Surge suppressor
- 6-42. All word processing programs and desktop publishing programs are compatible.
1. True
  2. False
- 6-43. Which of the following is NOT a requirement in selecting desktop publishing software?
1. It must be able to convert files from your current word processing program
  2. It must be compatible with your hardware
  3. It must be capable of operating on a local area network
  4. It must have a good graphics file
- 6-44. Which of the following is NOT an example of desktop publishing software for a PC-based system?
1. Aldus Pagemaker
  2. QuarkXPress
  3. Legacy
  4. Ventura Publisher

- 6-45. In line engraving, an acetate shading sheet applied to original art serves what purpose?
1. It converts the illustration into a pattern of dots of varying sizes
  2. It introduces flat, gray tones by means of small, black solids of a single size, separated from one another by white space
  3. It prevents the art from yellowing by shielding out unwanted light
- 6-46. In preparing a page paste-up, when would you NOT paste up a piece of line art?
1. When the artwork hasn't been photographed through a halftone screen
  2. When the artwork requires enlarging or reducing
  3. When the artwork consists of two or more cartoon panels
- 6-47. How should you indicate the margins and guidelines on your paste-up?
1. Draw them in with black india ink
  2. Have the layout sheets printed with the lines in black
  3. Draw in light blue lines or have them printed in blue on the layout sheets
  4. Lightly draw them in with a pencil
- 6-48. You do not have a headliner machine at your command. What can you use to set headlines for your photo-offset newspaper?
1. Paper letters, such as Fototype
  2. Letters printed on wax acetate, such as Art Type
  3. Rub-on transfer letters
  4. Each of the above
- 6-49. To mask out an area on a paste-up to indicate the size, shape and position of a halftone, you would use which of the following materials?
1. India ink
  2. Black paper
  3. Red adhesive film
  4. Each of the above
- 6-50. If a halftone is irregular in shape, the photo can be pasted on the line paste-up when which of the following devices is used?
1. A mirror
  2. A window
  3. A doot-
  4. A chimney
- 6-51. A newspaper measuring 12 inches by 18 inches and having five columns is said to be what format?
1. Magazine
  2. Full format
  3. Tabloid
  4. Compact
- 6-52. Which of the following characteristics determines the format of the newspaper?
1. The position of the lead story
  2. The number of halftones used
  3. The shape, size and general physical form
  4. The newspaper's editorial policy
- 6-53. The design for a newspaper should accomplish which of the following purposes?
1. Emphasize which material presented is most important
  2. Draw and hold the reader's eye
  3. Allow the reader to obtain the most information in the shortest amount of time
  4. All of the above



- 6-54. A detailed plan or sketch showing the arrangement of art, headlines and copy to guide in making up the actual pages is known by what term?
1. A paste-up
  2. A dummy
  3. A matrix
  4. A pattern
- 6-55. In planning a page for a newspaper, the columns on your layout sheet should be drawn in which of the following ways?
1. To scale only
  2. To size only
  3. To scale or size, as desired
  4. To rough approximation of actual size
- 6-56. On a layout sheet, what is the recommended way for you to indicate where a particular story goes?
1. Slug the story
  2. Number the story
  3. Write the lead on the layout sheet
  4. Draw an arrow from the headline of the story to the space on the layout sheet
- 6-57. A story is under a two-column head with each column measuring 5 inches down the page. How many column inches does the story fill?
1. 5
  2. 2
  3. 7 1/2
  4. 10
- 6-58. You've typewritten a story that is 10-point type on two 8 1/2- by n-inch paper, 45 lines long. Your newspaper has five columns at 14 picas each. How many column inches will your story occupy?
1. 5
  2. 11
  3. 15
  4. 22
- 6-59. Figure 8-8 in your textbook illustrates a typical news story as edited and submitted to the printer. Which part of the copy is the slug line?
1. The sentence beginning, "Navy Enlisteds"
  2. Exam
  3. JOSN Jackson
  4. "A-head, 3 col."

## ASSIGNMENT 7

Textbook Assignment: "Printing, Layout and Makeup" (continued), pages 8-12 through 8-30.

---

- 7-1. What photograph cropping procedure is the most accurate and most commonly used by the Navy?
1. Masking
  2. Cutting
  3. Cutlining
  4. Marking margins with grease pencil or ink
- 7-2. You must crop a valuable photo of which you have only one print. What procedure(s) should you follow?
1. Marking with grease pencil
  2. Scaling only
  3. Masking only
  4. Masking and scaling
- 7-3. You have a photo that is 3 inches wide and 5 inches deep. You wish to use it as a two-column picture, which is 5 inches wide. For the enlarged photo, how many inches in depth should you mark off on the layout?
1. 5 in.
  2. 8 in.
  3. 8 1/3 in.
  4. 8 3/4 in.
- 7-4. Concerning type size, 1/2 inch is equal to how many points?
1. 12
  2. 24
  3. 36
  4. 72
- 7-5. In measuring type, six picas is equal to how many points?
1. 12
  2. 24
  3. 36
  4. 72
- 7-6. The width of a line of type is measured in which of the following dimensions?
1. Picas
  2. Points
  3. Inches
  4. Millimeters
- 7-7. The height of a letter of type is measured in which of the following dimensions?
1. Millimeters
  2. Points
  3. Picas
  4. Inches
- 7-8. What term is used to describe the different styles of type?
1. Faces
  2. Series
  3. Families
  4. Serifs
- 7-9. When selecting type, what should you consider first?
1. Dignity
  2. Clarity
  3. Boldness
  4. Strength
- 7-10. The principle difference between old style and modern Roman types is that old style has which of the following characteristics?
1. Rounded serifs
  2. Thin hairlines
  3. Straight serifs
  4. Heavier shadings

7-11. What is the name given to the typeface characterized by slanted letters that is made to match almost every type style in use?

1. Script
2. Gothic
3. Italics
4. Text

7-19. Typefaces that bear a close resemblance to each other but are not exactly alike in design are known by which of the following names?

1. Series
2. Races
3. Families
4. Fonts

---

IN ANSWERING QUESTIONS 7-12 THROUGH 7-16, SELECT FROM COLUMN B THE TYPEFACE CUSTOMARILY USED FOR THE PURPOSE STATED IN COLUMN A. RESPONSES MAY BE USED MORE THAN ONCE.

7-20. What is the complete assortment of type in one size and style called?

1. Case
2. Class
3. Series
4. Font

<u>A. PURPOSES</u>	<u>B. TYPE-FACE</u>
--------------------	---------------------

7-12. To print the text of newspapers, books and magazines	1. Roman 2. Gothic
--	-----------------------

7-13. To print formal material, such as invitations	3. Contemporary
---	-----------------

7-14. To print advertisements, compositions and TV commercials

7-15. To print labels on cans and boxes

7-16. To print posters and newspaper headlines

7-21. When you use an initial letter to begin a page or a paragraph, what rule is generally followed?

1. The entire sentence is capitalized
2. The rest of the word is capitalized
3. The remainder of the word is italicized
4. The rest of the sentence is printed in boldface

7-22. When you select ornaments for a print job, what is the general rule to follow?

1. Select ornaments for decoration only
2. Abundantly decorate the job with ornaments
3. Select ornaments that contrast with the type
4. Use ornaments that correspond with the type

---

7-17. What typeface is used to emphasize work in text material?

1. Roman
2. Italics
3. Script
4. Text

7-23. What is meant by the focal point of a newspaper page?

7-18. What typeface most closely resembles handwriting?

1. Script
2. Italics
3. Gothic
4. Text

1. The name of the newspaper
2. The area where the reader normally expects to find the most important story
3. The area occupied by the largest picture
4. The most attractive area of the page

- 7-24. What device was used by newspaper editors of the '30s and '40s to establish the upper right-hand corner of a newspaper page as the focal point?
1. Arrows
  2. Art
  3. Banner headlines
  4. Sub-heads
- 7-25. What area, if any, is considered best for use as the front-page focal point for a newspaper?
1. Upper right-hand corner
  2. Upper left-hand corner
  3. Upper center
  4. None
- 7-26. On an inside page with no advertising, where is the focal point?
1. Upper right-hand corner
  2. Upper left-hand corner
  3. Upper center
  4. Center page
- 7-27. On an inside page with a mass of advertising in the lower left corner, where is the focal point?
1. Lower left-hand corner
  2. Lower right-hand corner
  3. Upper left-hand corner
  4. Upper right-hand corner

---

IN ANSWERING QUESTIONS 7-28 THROUGH 7-32 IN THE FOLLOWING COLUMN, SELECT FROM COLUMN B THE TYPE OF MAKEUP LINE CHARACTERIZED BY THE INFORMATION IN COLUMN A USED AS THE QUESTION. RESPONSES MAY BE USED MORE THAN ONCE.

- | <u>A. INFORMATION</u>  | <u>B. MAKEUP LINE</u>                               |
|--|---|
| 7-28. Tends to add rhythm to a page and encourages the reader to read through the page   | 1. Circle<br>2. Diagonal<br>3. Horizontal           |
| 7-29. Places equal importance on all stories   | 4. Vertical   |
| 7-30. Was used in makeup in early America  |   |
| 7-31. Introduced in World War II and is the most striking change in newspaper appearance this century  |   |
| 7-32. Used to get reader to read back and forth on page  |   |
| <hr/>  |   |
| 7-33. Which of the following design concepts is used to standardize the day-to-day appearance of a newspaper?  | 1. Balance<br>2. Unity<br>3. Rhythm<br>4. Harmony   |
| 7-34. Separating display items to give each the attention it deserves on a newspaper page is the practice of which of the following design concepts? | 1. Balance<br>2. Contrast<br>3. Unity<br>4. Harmony |
| 7-35. A paneled page is one that lacks adherence to which of the following design concepts?  | 1. Balance<br>2. Harmony<br>3. Contrast<br>4. Unity |

- 7-36. Which of the following elements help the reader to identify a particular newspaper?
1. Masthead, headlines and devices
  2. Nameplate, flags and devices
  3. Nameplate, masthead and flags
  4. Flags, headlines and nameplate
- 7-37. Which of the following elements of the newspaper include(s) the disclaimer?
1. The flag
  2. The nameplate
  3. The masthead
  4. All of the above
- 7-38. To indicate the section pages of a newspaper, you should use which of the following newspaper makeup elements?
1. Nameplates
  2. Flags
  3. Mastheads
  4. Section logos
- 7-39. The disclaimer is a component of which of the following newspaper makeup elements?
1. Nameplate
  2. Flag
  3. Masthead
  4. Section Logo
- 7-40. Which of the following newspaper makeup elements contribute to all of the five concepts of newspaper design?
1. Flags
  2. Mastheads
  3. Typographic devices
  4. Headlines
- 7-41. A story requiring a jump should be split in which of the following ways?
1. At the end of a paragraph
  2. At the end of a sentence not ending a paragraph only
  3. In midsentence only
  4. Either 2 or 3 above, depending on editorial preference
- 7-42. In newspaper makeup design, which of the following practices should NOT be done?
1. Separate the headline of one story from that of another
  2. Place pictures between headlines and their accompanying stories when possible
  3. Decrease the point size of headlines as they descend the page
  4. Keep all stories under their respective headlines
- 7-43. Concerning pictures in newspaper makeup design, which of the following practices is NOT recommended?
1. Stand pictures on either a headline, another picture or the bottom of a page
  2. Float a picture of two-column width or more in the copy
  3. Separate unrelated pictures with body type
  4. Give important pictures maximum display on a page
- 7-44. Which of the following examples represents the best use of a thumbnail photo?
1. It is positioned so that it looks into the story or out of the page and has a name line
  2. It is printed one column wide and floated in the copy above a name line
  3. It shows action or motion and is used to guide the reader's eye through a page
  4. It should give a "thumbnail sketch" of the story, and it should be at least two columns wide and placed at the end of the story
- 7-45. Which of the following techniques may be used to break up the grayness of a page?
1. Using boxes and dingbats
  2. Using pictures effectively
  3. Using a variety of type
  4. All of the above

- 7-46. Which of the following typographic devices are commonly favored by contemporary newspaper editor-s to separate unrelated items and to unite related items?
1. Column rules and cutoff rules
  2. End dashes and jim dashes
  3. Cutoff rules and dinky dashes
- 7-47. Reefers are used to break up grayness on a page by employing which of the following typographical devices?
1. A hammerhead
  2. Dingbats
  3. A sandwich
  4. An initial letter
- 7-48. Which of the following elements identifies a newspaper on each page of the publication?
1. A dateline
  2. A folio line
  3. A window
  4. A flag
- 7-49. All special pages of a newspaper should have which of the following traits in common?
1. Artistic designs
  2. Individual personalities
  3. A similarity in makeup
  4. Action pictures
- 7-50. What factor determines the format to be used in laying out a picture story?
1. The importance of the story
  2. The space limitations of the publication
  3. The expressed interests of the publication's readers
  4. The number of photographs available
- 7-51. In a picture story, what picture is the most important?
1. The central picture in the body
  2. The closing picture
  3. The lead picture
- 7-52. For a picture story layout, the subject of the lead photograph should face in what direction?
1. To the viewer's right
  2. Downward
  3. Straight out of the page
  4. To the viewer's left
- 7-53. Headlines, cutlines and text in a picture story layout serve which of the following functions?
1. They provide facts to supplement the pictures editorially
  2. They serve graphically as elements of composition
  3. Both 1 and 2 above
  4. They duplicate the message in the pictures
- 7-54. What are the initial copies of your typeset stories called?
1. Galley proofs
  2. Galleys only
  3. Proofs only
  4. All of the above
- 7-55. What method of noting proof-reader's marks requires the editor to draw lines to the error and place the proofreading symbol in the margin?
1. Book system
  2. Guideline system
  3. College system
  4. AP system

A. Mans odds for survival in polar area could be

B. greatly increased as a result of 2 recent inventions

c. sponsored by the coast guard.

D. The inventions include a light weather-Resistant tent,

E. and a blanket which, when folded, will fit in the palm

F. of the hand Both are designed to conserve body warmth.

G. Light, portable and easily assembled, the tent is

H. made of fabric which is windproof and water proof.

I. Yet it is porous enough to permit the escape of body

3. moisture while retaining the occupants body heat.

K. The blanket is made of light, aluminized plastic film

L. which possesses unusual toughness and durability. This

M. type film is presently used in space operations.

N. Although the blanket measures 56 by 84 in, it

O. be can folded into a small, rectangular package suitable

P. for easy for handling.

Figure 7-A.--A galley proof to be proofread

FIGURE 7-A IS AN ARTICLE TO BE PROOFREAD AND EDITED. THE LETTERS PRECEDING EACH LINE ARE REFERENCES IN ANSWERING QUESTIONS 7-56 THROUGH 7-67. PROOFREAD THE ARTICLE, USING THE APPROPRIATE MARKS GIVEN IN FIGURE 8-21 OF YOUR TEXTBOOK, THEN ANSWER THE FOLLOWING QUESTIONS.

7-56. What symbol should you enter to correct the possessive cases in lines A and J?

1. ↘ ↙ ↗ ↖
2. ∘
3. ∙
4. ↙ ↘



7-57. What indication should you make to show the printer that the number in line B and the measurement in line N are to be spelled out?

1. ~~AP~~
2. two and inches
3. 7
4. ~~ld~~

7-58. Which of the following marks should you use on line C?

1. //
2. m
3. C + sc
4. =/

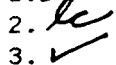



7-59. What mark should be used for the error in line D?

1. 
2. 
3. 
4. *no cap*



7-60. In line E, assume that you made marks to remove the commas preceding and following "when folded." However, you now decide to retain the commas. What should you write to indicate that fact?

1. Don' t change
2. Disregard
3. Stet
4. Replace commas



7-61. Which of the following marks should you use to correct the punctuation of line F?

1. 
2. 
3. 
4. 



7-62. What mark indicates that punctuation has been omitted from line G?

1. 
2. 
3. 
4. 



7-63. What mark should you use for line H to indicate that "water proof" is one word?

1. 
2. 
3. 
4. 

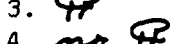

7-64. What mark should you use to indicate that line I continues the sentence begun on line G?

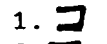
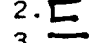
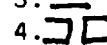
1. 
2. 
3. 
4. *no ff*

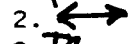

7-65. What mark should you enter to correct line M?

1. 
2. 
3. 
4. 

7-66. What symbol you insert at line O to indicate the transposition of words?

1. 
2. 
3. 
4. 

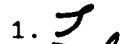
7-67. What mark should you use to eliminate the duplicated word in line P?

1. 
2. *Delete*
3. 
4. 



## ASSIGNMENT 8

Textbook Assignment: "Printing, Layout and Makeup" (continued) and "Writing Headlines and Cutlines," pages 8-31 through 9-15.

- 
- 8-1. What is the primary reason for designing a newspaper page?
1. To decrease the time required in the makeup process
  2. To make the page easier to read
  3. To provide equal treatment to all major stories
  4. To keep readers from becoming bored with one repetitious pattern

- 8-2. Which of the following patterns is representative of contemporary style magazines?
1. Formal balance
  2. Focus
  3. Grid
  4. Quadrant

- 8-7. The reader's attention is directed to the upper corners of the page by the stairstep arrangement of headlines

- 8-8. This design is characterized by such elements as immense type and large art masses in unorthodox shapes

- 
- 8-9. In which of the following design patterns is the page divided in half vertically and, for each element placed on one side of the center line, a duplicate element is placed at the same point on the opposite side?

1. Dynamic balance
2. Functional
3. Formal balance
4. Modular

- 8-10. Which of the following designs follows no set pattern and allows the news to dictate the layout?

1. Formal balance
2. Functional
3. Horizontal
4. Dynamic balance

---

IN ANSWERING QUESTIONS 8-3 THROUGH 8-8, SELECT FROM COLUMN B THE DESIGN PATTERN CHARACTERIZED BY THE STATEMENT IN COLUMN A. RESPONSES MAY BE USED MORE THAN ONCE.

A. STATEMENTS

B. CATEGORIES

- 8-3. The page is divided into quarters and a major element is placed in each quarter
- 8-4. The news is made up on a diagonal line that calls the reader's attention to most important story on the page
- 8-5. The news is presented so that all elements vie for the reader's immediate attention
- 8-6. The page is divided in half vertically

1. Focus
2. Dynamic balance
3. Quadrant
4. Circus

IN ANSWERING QUESTIONS 8-11 THROUGH 8-15, SELECT FROM COLUMN B THE DESIGN PATTERN CHARACTERIZED BY THE STATEMENT IN COLUMN A. RESPONSES MAY BE USED MORE THAN ONCE.

	<u>A. STATEMENTS</u>	<u>B. CATEGORIES</u>
8-11.	Large multi-column headlines, large horizontal pictures	1. Horizontal 2. Modular
8-12.	This format came about from a study that showed that readers estimate they read horizontal copy faster than vertical copy	3. Grid
8-13.	Intersecting lines are used to form rectangles to give a page the look of modern magazines	
8-14.	Pleasing vertical and horizontal rectangles are combined and irregular story shapes are avoided	
8-15.	A strong vertical chimney is the earmark of this design pattern	
<hr/>		
8-16.	Which of the following design patterns places a strong emphasis on a single story or issue?	
		1. Focus 2. Total 3. Functional 4. Grid
8-17.	What design, if any, is best for a ship or station newspaper?	
		1. Horizontal 2. Functional 3. Dynamic balance 4. None

- 8-18. Around the time of the Spanish-American War, which headline form was introduced?
1. Initial letter
  2. Multi-column heads
  3. Multi-decked heads
  4. Streamlined, compact heads
- 8-19. In colonial America, what was the predominant headline form?
1. Initial letter
  2. Multi-column heads
  3. Multi-decked heads
  4. Streamlined, compact heads
- 8-20. In the modern period following World War I, what headline type came into prominence?
1. Initial letter
  2. Multi-column heads
  3. Multi-decked heads
  4. Streamlined, compact heads
- 8-21. Which of the following pairs of adjectives best describe a good, modern headline?
1. Long and specific
  2. Brief and dramatic
  3. Long and informative
  4. Brief and informative
- 8-22. What facet of the story helps determine the size of a headline?
1. The prominence of the persons in the story
  2. The importance of the story
  3. The interest of the story to the reader
  4. The timeliness of the story
- 8-23. The headline "Navy to Buy Whole Town" illustrates what headline style?
1. Downstyle
  2. All caps
  3. Upper and lower head
  4. Lower head

- 8-24. A single-line headline across the top of the page is what type of headline?
1. Hammerhead
  2. Kicker
  3. Banner
  4. Readout
- 8-25. The headline "Upgrading urged for nation's railroads" illustrates what headline style?
1. Downstyle
  2. All caps head
  3. Upper and lower head
  4. Lower head
- 8-26. What headline style is the most difficult to read?
1. Downstyle
  2. All caps head
  3. Upper and lower head
  4. Lower head
- 8-27. In a flush-left head, the lines must be of equal length.
1. True
  2. False
- 8-28. A headline that is twice the size and set flush left above the main head is known by what term?
1. Tripod
  2. Hammerhead
  3. Rocket
  4. Wicket
- 8-29. What is the composition of the tripod head?
1. A short line of larger type set flush left and above two lines of smaller type
  2. Two lines of small type to the right of a short line of larger type twice the size of the smaller
  3. A single, short line of smaller type to the left of two lines of larger type
  4. A larger type centered above the main head of smaller type
- 8-30. What is the unit count system?
1. A unit value assigned to each character expressing its height relationship to other characters
  2. A unit value assigned to each character expressing its width relationship to other characters
  3. The unit value assigned to each character expressing the style in point size and line count
  4. An expression of the height and width of each character in terms of units
- 8-31. What letters each equal two units in an all-cap headline?
1. M and W
  2. N and O
  3. P and Q
  4. R and S
- 8-32. What letter of the alphabet is counted as one-half unit whether capitalized or lower case?
1. s
  2. q
  3. i
  4. d
- 8-33. In headline counting, all numerals, with one exception, equal how many units?
1. 1
  2. 2
  3. 1/2
  4. 1 1/2
- 8-34. Which of the following punctuation marks is evaluated as 1 1/2 units?
1. Exclamation mark
  2. Question Mark
  3. Apostrophe
  4. Semicolon

- 8-35. For what purpose should you use a headline chart?
1. To determine the minimum and maximum count for each line of a specific style and size of type
  2. To determine the point size of a given style of type
  3. To select the proper style of type to use for any given headline
  4. To compose a headline that fits within the minimum and maximum count per newspaper column
- 8-36. Which of the following sizes of type is the largest?
1. 60 pt
  2. 48 pt
  3. 30 pt
  4. 24 pt
- 8-37. Assume you have a three-column headline of 24 units. Which letter-number key in figure 9-13 of the text should you use in your code to the printer?
1. B5
  2. D3
  3. F3
  4. G3
- 8-38. In striving to write brief headlines, you often omit which of the following parts of speech?
1. The action verb
  2. Nouns used as subjects
  3. Adjectives, adverbs and articles
  4. Abbreviations
- 8-39. Which of the following is a rule for verb use in headlines?
1. Use active verbs in the past tense
  2. Use active verbs in the historical present tense
  3. Use passive verbs in the past tense
  4. Use passive verbs in the historical present tense
- 8-40. Which of the following is the rule for verb and article use in headlines?
1. Verbs may be omitted, articles may not
  2. Verbs and articles are required
  3. Verbs and articles may be omitted
  4. Verbs may be omitted; articles are always omitted
- 8-41. Which of the following headlines is written in the best style?
1. Bar S. Africa  
From Olympics
  2. Voters Bar  
S. Africa
  3. Olympic Committee  
Bars South Africa
  4. S. Africa is Barred  
From Olympic Games
- 8-42. "Young pedestrian shot in leg" is a better headline than "Injuries sustained by child" for what reason?
1. It is more specific
  2. It is more positive
  3. It includes more of the five Ws
  4. It uses more short, active words
- 8-43. For what reason is "Clinton sees peace talks soon" a better headline than "Peace talks may begin next week?"
1. A good headline always answers "what" first
  2. Opinion stories should include attribution in the headline
  3. It is more specific
  4. It contains more short, active words
- 8-44. Which of the five Ws can generally be omitted in the headline of a local story?
1. Where
  2. When
  3. Who and what
  4. Where and when

- 8-45. The main reason headline writers use a specialized vocabulary is the necessity for which of the following?
1. Colorful writing
  2. Brevity
  3. Clarity
  4. Originality
- 8-46. Under what circumstances may you use the abbreviation SECNAV in a headline?
1. When space constraints make it necessary
  2. When you spell out the title in the lead of the story
  3. When the press release goes to a broadcast outlet
  4. When the headline is for a Navy publication
- 8-47. What is the purpose of a picture cutline?
1. To add interest to the picture
  2. To tell the complete story
  3. To add information that, together with the picture, tells the story
  4. To identify the picture elements
- 8-48. Gathering information for a cutline is similar to compiling material for what other publication element?
1. A film script
  2. An editorial cartoon
  3. A brief TV or radio announcement
  4. A news story
- 8-49. What is the rule for the length of a cutline?
1. Use one line
  2. Use one sentence
  3. Use two or three lines
  4. Use the fewest words that will convey the message clearly
- 8-50. Which of the following is a principle about the style of writing cutlines?
1. The cutline should arouse, but not satisfy, the reader's curiosity
  2. The style varies according to the type of picture and the policies of the individual publication
  3. The cutline should serve as a lead-in to an accompanying story
  4. The style is always the same for any type of picture
- 8-51. What are the major components of a cutline?
1. Lead, bridge, action and credit line
  2. Tie-back, identification, attribution and conclusion
  3. Identification, tie-in, action and background information
  4. Action, background information, credit line and identification
- 8-52. The first sentence in a good cutline usually describes or names which of the following picture elements?
1. The action shown, or "what"
  2. The persons shown, or "who"
  3. The background details, or "when"
  4. The news peg, or "why"

8-53. You are writing a cutline for a news photo that shows a Navy plane on fire after being struck by lightning. Which of the following first sentences is the best?

1. Fire fighters save lightning-struck Navy plane
2. Fire fighters combatted flames on a Navy plane struck by lightning
3. Fire fighters at Memphis Naval Air Station pumped foam on burning plane set afire by lightning
4. Foam pumped on this Navy plane, struck by lightning, put out the fire before great damage was done

8-54. The "when" element in a cutline, if needed, is usually included where?

1. In the news story, not in the cutline
2. At the end of the cutline
3. In the second sentence of the cutline
4. In the first sentence of the cutline

8-55. A photo shows two statesmen arriving by plane from an important meeting. One of the men is partially obscured by the other one. No one in the welcoming crowd can be seen clearly. Who should be identified by name?

1. Only the statesman seen clearly in the picture
2. Both statesmen
3. Both men and important welcomers who are not clearly shown
4. Only the partially obscured statesman, if the clearly seen one is well-known

8-56. Which of the following descriptions about the identification of persons illustrates good cutline writing?

1. The identification of six persons shown inspecting a building site appears in the first sentence of the cutline
2. A group of winners in a contest is captioned, top row, left to right, and bottom row, left to right. Over the picture is the phrase "contest winners"
3. A presidential candidate is shown donning a war bonnet presented by a costumed Native-American. Both are named in the first sentence of the cutline
4. A Navy member is shown applying mouth-to-mouth resuscitation to a child lying on a beach. The child's name was not known and that fact was not mentioned in the cutline

8-57. The amount of background information needed in a cutline is influenced by which of the following factors?

1. Who is in the picture and what is being depicted
2. When and where the action occurred
3. Why the picture was taken and what the story tells
4. How and where the picture will be used

8-58. How should you use verb tenses in cutlines?

1. Use present, past and future tenses as in any writing
2. Use the present tense throughout
3. Describe the action in the present tense, and use appropriate tenses for background information
4. Use the past tense throughout

8-59. Where is the recommended position of the credit line in the outline?

1. Preceding the action element
2. Following the action element
3. Preceding the background information
4. following the background information

## ASSIGNMENT 9

Textbook Assignment: "Writing Headlines and Cutlines" (continued) and "Libel, Right of Privacy, Freedom of Information and Copyright," pages 9-16 through 10-15.

---

- 9-1. By which of the following methods of cutline typography may you heighten the impact of a picture for better display?
1. By setting the cutline in a larger typeface than the news column
  2. By setting the cutline boldface in the same style and size of type as the news column
  3. By using a different typeface than that in the news column
  4. Each of the above
- 9-2. The cutline for a three-column photo is wrapped when it is set in what way?
1. As a single column stretching the full length of the photo
  2. As a column of two-column width and centered under the photo
  3. As two columns, each one and a half columns in width and set side by side
  4. As three columns of one column width each and set side by side
- 9-3. A three-column picture carries a two-column wide cutline to the right and a caption under the left hand column. What is the caption called?
1. An underline
  2. An overline
  3. A lead-in
  4. A side catchline
- 9-4. Assume that a publication containing pictures is to be produced on the offset press. How may you save space if one of the pictures lends itself to this method?
1. Mortise the cutline into the picture
  2. Run the cutline beside the picture
  3. Place the cutline below the picture
  4. Locate the cutline above the picture
- 9-5. What principle should you observe when you lay out a page containing pictures, cutlines and accompanying stories?
1. Always run the picture and accompanying story side by side
  2. follow tradition and place the cutline below the story
  3. Consider the picture and its cutline as one element
  4. Run the cutline beside the picture
- 9-6. You write a story and have a photo to accompany it. You learn the newspaper has space problems and can use the photo only. What, if anything, should you do?
1. Rewrite the story to shorten it
  2. Ask the layout artist to find another spot for the story and key the story and picture appropriately
  3. Rewrite the cutline to include all the essential facts
  4. Nothing



- 9-7. You are training a JO striker, He has both a picture and story material for the station newspaper. You should suggest that he begin writing which element first?
1. The story
  2. The outline
  3. The headline
  4. The dateline
- 9-8. A dateline for a photograph is required when a picture is submitted under which of the following conditions?
1. When it's set for immediate release to a ship's newspaper
  2. When it's prepared for external release
  3. When it's accompanied by a story
  4. When it has no outline
- 9-9. Which of the following statements is true of libel and slander?
1. Libel is spoken, slander is written
  2. Slander is spoken, libel is written
  3. Reporters are protected by libel and slander charges by the First Amendment to the U.S. Constitution
  4. Libel and slander laws are federal statutes
- 9-10. What statement best defines libel?
1. Libel is a printed lie about somebody
  2. Libel is a published defamation that unjustly holds a person up to ridicule
  3. Libel is a spoken defamation that unjustly holds a person up to ridicule
  4. Libel is a defamation that results in a sensational court case
- 9-11. For a statement to be libelous, which of the following conditions must be present?
1. The statement must have clearly identified the person in question
  2. The statement must have been published
  3. The character or property of the person in question must have been degraded
  4. Each of the above
- 9-12. For what reason does a respectable news medium obey the libel laws?
1. It believes in the dignity of the individual
  2. It wishes to shun controversy
  3. It does not desire adverse criticism
  4. It does not wish to be closed by the government
- 9-13. Which of the following acts would constitute libel?
1. A newspaper's attack on an individual's personal reputation
  2. A comment regarding the political position of a candidate
  3. A review of a new movie
- 9-14. A reporter writes a story accusing a county official of taking bribes. His paper prints it, the UPI picks it up and other newspapers print it as well. The accused official sues. Who could be named as a defendant in the suit and be held liable for damages?
1. Only the reporter who wrote the story
  2. Just the newspapers that ran the story
  3. Only the original newspaper
  4. Everyone who had anything to do with the story

- 9-15. What are the two types of libel?
1. Libel per quod and defamation
  2. Libel per se and defamation
  3. Libel per quod and libel per se
  4. Libel per se and slander
- 9-16. A feature story about a presidential candidate stresses his strong affiliation with and loyalty to a particular church. It also states later in the article that the church discriminates against several ethnic groups, implying that the candidate shares those views. What term best describes the legal posture of the story?
1. Libel per se
  2. Libel per quod
  3. Uncontradicted rumor
  4. Fair comment or criticism
- 9-17. In a small town, the newspaper publisher is the brother of a prominent doctor who runs the local clinic. When a new doctor comes to town and opens an office, the newspaper publishes a story about him. The article tells of the new doctor's involvement in a malpractice suit, but fails to mention he was acquitted of the charge. What term best describes the legal posture of the story?
1. Libel per se
  2. Libel per quod
  3. Uncontradicted rumor
  4. Fair comment or criticism
- 9-18. A newspaper article states that a candidate for Congress is said to be a former member of the Ku Klux Klan. The purpose of the claim is apparently to discredit the candidate through association. The candidate states that the accusation was based on a wrong identification. If the candidate's claim is true, what term best describes the legal posture of the story?
1. Libel per se
  2. Libel per quod
  3. Uncontradicted rumor
  4. Fair comment or criticism
- 9-19. In a city crippled by a transit strike, the mayor refuses to appoint an arbitrator to consider the union's grievances. A local newspaper accuses the mayor of neglecting the public welfare. The mayor sues the paper. What term best describes the legal posture of the story?
1. Libel per se
  2. Libel per quod
  3. Uncontradicted rumor
  4. Fair comment or criticism
- 9-20. Whether words involved in a libel suit are libelous is determined by which of the following parties?
1. The courts
  2. The plaintiff
  3. The defendant
  4. The public
- 9-21. What type of libel is considered most serious and can support a lawsuit in itself?
1. Libel per se
  2. Libel per quod
  3. Civil libel
  4. Slander
- 9-22. The legal action of one individual suing a corporation for alleged defamation may result from which of the following classes of libel?
1. Seditious
  2. Obscene
  3. Civil
  4. Criminal
- 9-23. Under what condition may an individual bring a civil libel suit against the U.S. government?
1. When the government has committed seditious libel
  2. When the government admits guilt of libel
  3. When the government will not settle out of court
  4. Only when the government consents to the suit

- 9-24. Who is the accuser in a criminal libel suit?
1. The Department of Justice
  2. The state
  3. The defendant
  4. The plaintiff
- 9-25. Which of the following are partial defenses that can lessen the damages assessed against a defendant in a libel suit?
1. Retraction (or apology) and good faith (or honest mistake)
  2. Truth and retraction (or apology)
  3. Fair comment and criticism
  4. Honest mistake (or good faith) and truth
- 9-26. Under what circumstances can the defense of "repetition" be used?
1. When a libelous story is repeated in a subsequent edition of the same publication before the libeled party can begin legal action
  2. When the libeled party has a history of committing the act reported on by the publication
  3. When a publication uses a libelous story that has been printed elsewhere
  4. When another publication is already charged with libel for the same story
- 9-27. What are two complete defenses against libel action that, if proved, will lead to acquittal?
1. Truth and honest mistake
  2. Fair comment and criticism and retraction
  3. Honest mistake and publishing an apology
  4. Truth for a good reason and fair comment and criticism
- 9-28. When will even ethical editors and reporters disregard an individual's right to privacy?
1. When the person is noteworthy
  2. When there is a compelling need to publish the information for the public good
  3. When the information is not libelous
  4. When they believe the information is about to be published by other newspapers
- 9-29. Current copyright laws in the United States are in what form?
1. State statutes
  2. The Copyright Act of 1976
  3. Federal copyright laws dating from 1909
  4. Current international treaties that the U.S. has signed
- 9-30. Which of the following is NOT eligible for copyright protection?
1. Audiovisual works
  2. Slogans and familiar symbols
  3. Choreographed works
  4. Sound recordings
- 9-31. Which of the following is NOT eligible for copyright protection?
1. Sculptures
  2. Facts and lists taken from public documents
  3. Maps photographs and drawings
  4. Technical encyclopedias
- 9-32. Where copyright protection applies, it is available to which of the following works?
1. Published works only
  2. Unpublished works only
  3. Both published and unpublished works
  4. Published works and original ideas

- 9-33. The Copyright Act of 1976 became effective on what date?
1. Jan. 1, 1976
  2. Jan. 1, 1977
  3. Jan. 1, 1978
  4. Jan. 1, 1979
- 9-34. A journalist quoting in a news story an excerpt from a popular novel without permission from the copyright holder is an example of which of the following terms?
1. Copyright infringement
  2. Doctrine of fair use
  3. Compulsory license limitation
  4. Plagiarism
- 9-35. While in the course of carrying out official duties, a Navy journalist infringes on a copyright. What legal action, if any, may the copyright owner take with the federal government's permission?
1. Sue only the journalist who infringed the copyright
  2. Sue the journalist and all persons who may have edited the material containing the infringement
  3. Sue only the U.S. government
  4. None
- 9-36. Which of the following materials is NOT subject to U.S. copyright laws?
1. Books written by professors at state universities
  2. Magazine articles written by Navy journalists during off-duty time
  3. Books published by the U.S. government
  4. Books written in federal prisons by convicted felons
- 9-37. When does copyright protection for a work begin?
1. At the moment the creator notifies the Copyright Office of the form of the work
  2. At the moment the idea for the work is conceived
  3. At the time the work is created in fixed form
  4. At the time it is labeled "copyrighted" by the U.S. Copyright Office
- 9-38. In the case of works made for hire, who is legally considered to be the author of such works?
1. Only the actual creator of the work
  2. Only the employer who commissioned the work
  3. Only the publisher of the work
  4. Anyone designated by the publisher of the work
- 9-39. Unless there is an agreement specifying ownership, who is the rightful owner of a joint work?
1. The publisher of the work
  2. The author who supplied the largest percentage of input to the work
  3. All contributing authors of the work are co-owners
  4. The first author to file the work with the Copyright Office
- 9-40. Under the current copyright laws, who owns the copyright on a work after the transfer of any material object that embodies a protected work has taken place?
1. The person holding the copyright before the transfer occurred
  2. The person to whom the material object was transferred
  3. Both 1 and 2 above, as co-owners
  4. The U.S. Copyright Office

- 9-41. Copyright protection is available for all unpublished works, regardless of the nationality or domicile of the author.
1. True
  2. False
- 9-42. To obtain copyright protection under the current copyright laws, which, if any, of the following actions is necessary?
1. The work must be published, containing a notice of copyright
  2. The work must be registered with the Copyright Office
  3. The work must be accepted by a publisher
  4. None of the above
- 9-43. Under the new copyright laws, when is a work considered created?
1. When it is published for the first time
  2. When it is fixed in a copy or phonorecord for the first time
  3. When the basic idea for the work is first conceived
  4. When the Copyright Office acknowledges the existence of the work
- 9-44. Which of the following examples constitutes publication of a work?
1. A copyrighted song is performed on network television by the songwriter
  2. A new manuscript is put in smooth form by the author's secretary
  3. Three thousand copies of a new book are printed by a publishing house
  4. The manager of a small, independent bookstore purchases 100 copies of a new book printed privately by the author
- 9-45. What is the significance of a particular work bearing the year of its publication date?
1. The date is used to determine the duration of copyright protection
  2. The date is used in determining the duration of copyright protection for an anonymous work or a work made for hire
  3. The date is used in determining the duration period between the publication of a work and the date the copyright can be renewed
  4. The date is used to indicate when a work has been deposited with the Library of Congress
- 9-46. The inclusion of a copyright notice on a work is the responsibility of which of the following parties?
1. The Registrar of the Copyright Office
  2. The copyright owner
  3. The Clerk of the Library of Congress
  4. The publishing house that prints the work
- 9-47. A book protected by copyright should bear a notice of copyright containing which of the following elements?
1. The name of the copyright owner, the date the book was registered with the Copyright Office, and the word "copyright" (can be abbreviated to "copr." or the symbol ©)
  2. The symbol ©, the year of last publication and the name of the Copyright Office official who registered the book
  3. The word "copyright" (can be abbreviated "copr." or the symbol ©), the year of first publication, and the name of the copyright owner
  4. The name of the copyright owner, the year of first publication and the registered trademark of the copyright owner

- 9-48. The letter "P" in a circle indicates what type of copyright notice?
1. Printed matter and illustrations
  2. Published works of any type
  3. Unpublished works of any type
  4. Phonorecords or sound recordings
- 9-49. Which of the following works is NOT eligible for retroactive protection under the new copyright law?
1. Works published before January 1, 1978, that did NOT carry a proper copyright notice
  2. Any work published before January 1, 1978
  3. Works published before January 1, 1978, in foreign countries
- 9-50. If the copyright notice was omitted on a work created after January 1, 1978, what action can the owner take to maintain copyright protection?
1. Exert a reasonable effort to correct the omission within five years of registration
  2. Notify the Copyright Office of the omission and request extended protection
  3. Accept the fact that nothing can be done to maintain protection on a work if it has no copyright notice affixed
- 9-51. Which of the following is NOT a benefit of registering a work with the Copyright Office?
1. It establishes a public record of the copyright
  2. It provides prima facie evidence in court to the validity of the copyright claim
  3. It is the only way to get copyright protection
  4. If made within three months of publication, lawyer's fees and statutory damages are available to the owner if the copyright is infringed upon
- 9-52. You have written a book about your experiences as a Navy journalist. What is the duration of the copyright protection for your work?
1. For 28 years from the date of first publication
  2. From the moment of first publication and enduring for 50 years after your death
  3. From the moment the work is created to 50 years after your death
  4. For 75 years from publication or 100 years from creation, whichever is shorter
- 9-53. In the case of a joint work prepared by two or more authors who did not work for hire, what is the duration of copyright protection?
1. From the work's creation to the death of the last surviving author
  2. From the first publication of the work to 50 years after the death of the last surviving author
  3. From the work's first publication to 50 years after the death of the first author
  4. From the work's creation to 50 years after the death of the last surviving author
- 9-54. For a work copyrighted before January 1, 1978, whose copyright is still in effect, what copyright renewal term is available?
1. 28 years
  2. 47 years
  3. The life of the present copyright owner
  4. The life of the author plus 50 years
- 9-55. When a work has been registered in unpublished form, a second registration is unnecessary when the work is published.
1. True
  2. False

9-56. During the registration process, how many copies should be deposited for a work published before January 1, 1978?

1. One copy as first published
2. One copy of the best edition
3. Two copies as first published
4. Two copies of the best edition

9-57. Which of the following is NOT a reason the concept of publication is important in copyright laws?

1. Works that are published must be deposited with the Library of Congress
2. The date of publication affects the copyright duration for anonymous or pseudonymous works
3. Publication is required for registration
4. Deposit requirements for registration differ based on publication

## ASSIGNMENT 10

Textbook Assignment: "Basic Photography," pages 11-1 through 11-42.

---

- 10-1. What are the two man-made essentials for taking a picture?
1. A camera and a light
  2. A film and a camera
  3. A light and a film
  4. A film and a lens
- 10-2. Modern photographic film is made by using an emulsion to coat which of the following substances?
1. Glass
  2. Paper
  3. Cellulose or polymer plastic
  4. Sheet gelatin
- 10-3. Which of the following groups of components is essential to a camera?
1. A lighttight box, an exposure calculator and an image support
  2. An optical system, an image support and a view finder
  3. An image support, a light-tight box and an optical system
  4. A focusing device, a light-tight box and an optical system
- 10-4. During processing, the developing solution changes the image of the exposed film into a visible image by what conversion process?
1. Metallic silver into silver halides
  2. Silver halides into metallic silver
  3. Silver halides into soluble salts
  4. Soluble salts into metallic silver
- 10-5. Making positive prints of various sizes from a photographic negative involves the use of which of the following equipment?
1. Contact printer
  2. Projection printer
  3. Printing frame
  4. Reducer and enlarger
- 10-6. After exposure but before development, the image on the film is known by what terminology?
1. Latent image
  2. Exposed image
  3. Halide image
  4. Monochromatic image
- 10-7. Which of the following camera features does NOT describe an SLR camera?
1. A mirror reflects the image formed by a single viewing and taking lens onto a viewing screen for focusing
  2. A reflex mirror in its focusing and viewing lens gives a reversed and inverted image on a ground-glass screen
  3. At the moment of exposure, viewing is disrupted for a split second, as the mirror swings out of the lens-to-film optical path
  4. It is not susceptible to the parallax problem
- 10-8. The design of the SLR allows the accomplishment of which of the following functions?
1. Judging the depth of field at a selected aperture
  2. Rapid film changing
  3. Speedy camera settings
  4. All of the above



- 10-9. Which of the following features is NOT common to modern SLR cameras?
1. Built-in, through the lens exposure meter
  2. Interchangeable lenses with sophisticated leaf shutters
  3. Focal plane shutters
  4. Interchangeable lenses with iris diaphragm
- 10-10. When you focus a camera, what is actually happening mechanically within the camera?
1. The lens is moving closer or farther from the focal plane
  2. The aperture is changing
  3. The mirror is moving closer or farther from the focal plane
  4. The focal plane angle is changing
- 10-11. How should you remove a smudge from a camera lens?
1. With any tissue only
  2. With a lens-cleaning tissue soaked with lens-cleaning solution
  3. With a lens-cleaning tissue moistened with one or two drops of lens-cleaning solution
  4. Any soft, dry cloth
- 10-12. How can you determine if a scratch on the lens is bad enough to require its replacement?
1. Any scratch will require replacement
  2. Focus the camera on an object, and check for obscured or blurred areas
  3. Give the lens to a local photo lab for a prism test
  4. Give the lens to your supervisor for his or her determination
- 10-13. What material(s) should be used to clean a camera body?
1. A soft tissue and cleaning fluid
  2. Cotton swab and water
  3. Silicon cloth or soft chamois
  4. Soft cloth and isopropyl alcohol
- 10-14. All photographic equipment used in picture making, other than cameras and lenses, is referred to by what terminology?
1. Photographic aids
  2. Camera accessories
  3. Non-optic material
  4. Camera bag items
- 
- IN ANSWERING QUESTIONS 10-15 THROUGH 10-17, SELECT FROM COLUMN B THE PHRASE THAT DESCRIBES OR APPLIES TO THE EQUIPMENT LISTED IN COLUMN A. NOT ALL RESPONSES ARE USED.
- |        | <u>A. EQUIPMENT</u> | <u>B. PHRASES</u>   |
|--------|---------------------|---|
| 10-15. | Autowinder          | 1. Glass optical element dyed to absorb colors selectively        |
| 10-16. | Filters             | 2. Shades used to keep sunlight from striking the front of a lens |
| 10-17. | Lens hoods          | 3. Devices used to increase light efficiency                      |
|        |                     | 4. Device that automatically advances exposed film                |

- 10-18. What direction of lighting produces the most natural form of illumination?
1. Light from directly above the subject
  2. Backlight from behind the subject
  3. Light from behind the camera and in front of the subject
  4. Light from one side and above the subject
- 10-19. The type of lighting you should use to bring out texture and provide depth to the subject is known by what terminology?
1. Frontlight
  2. Backlight
  3. Light from directly above or below
  4. Sidelight
- 10-20. A photojournalist often uses electronic flash for which of the following purposes?
1. To fill in shadow areas
  2. To stop a subject's motion
  3. To increase illumination
  4. All of the above
- 10-21. What lighting technique should you use to photograph a silhouette?
1. Sidelight the subject and overexpose
  2. Backlight the subject and underexpose
  3. Sidelight the subject and underexpose
  4. Overexpose with the subject backlit
- 10-22. Which of the following is NOT a primary color?
1. Red
  2. Blue
  3. Green
  4. Cyan
- 10-23. You are taking a black and white picture of a blond child standing on a green lawn. She is wearing a pale yellow dress. You can make a more natural-looking photo and make the yellows and greens a darker gray by using what type of filter?
1. Blue
  2. Yellow
  3. Green
  4. Red
- 10-24. You want to photograph an old map that has the important boundaries drawn with red ink. The marks are rather faint in color, so to darken them, you use a filter in what complimentary color?
1. Yellow
  2. Red
  3. Cyan
  4. Magenta
- 10-25. The filter factor, which affects the amount of exposure needed, depends partly on which of the following factors?
1. The color of the filter
  2. The latitude of the film
  3. The intensity of the light source
  4. The aperture setting on the camera
- 10-26. You are using a light red filter with a factor of 8.0 in daylight. The exposure should be increased by, (a) how much and the diaphragm must be opened, (b) how many stops?
1. (a) 2 times; (b) 2 stops
  2. (a) 4 times; (b) 3 stops
  3. (a) 8 times; (b) 3 stops
  4. (a) 8 times; (b) 4 stops
- 10-27. What term denotes the amount of light that acts upon a photographic film?
1. Intensity
  2. Sensitivity
  3. Reflection
  4. Exposure

- 10-28. What technical error is responsible for ruining more photographs than any other?
1. Wrong filter selection
  2. Incorrect exposure
  3. Improperly operating flash equipment
  4. Wrong film selection
- 10-29. Which of the following terms expresses the formula for exposure?
1. Intensity x time
  2. Sensitivity x time
  3. Intensity x film speed
  4. Time divided by intensity
- 10-30. All except which of the following are factors that govern correct film exposure time?
1. The size of the lens opening
  2. The shutter speed
  3. The intensity and nature of the light
  4. The sensitivity of the film
- 10-31. What term defines the range between the minimum and maximum satisfactory exposures of film?
1. Block
  2. Sensitivity
  3. Latitude
  4. Intensity
- 10-32. Film speed is a measure of what film characteristic?
1. Maximum development time
  2. Sensitivity to color
  3. Sensitivity to light
  4. Minimum development time
- 10-33. What designation is given the universal expression for uniform film-speed standards?
1. USS
  2. UEV
  3. ISO
  4. DIN
- 10-34. Most panchromatic films are sensitive to all visible light in the same degree as the human eye.
1. True
  2. False
- 10-35. What type of color film is identified by the suffix "color"?
1. Slide film
  2. Print film
  3. Reproduction paper
  4. Transparencies
- 10-36. What does stopping down the lens mean?
1. Increasing the size of the lens aperture
  2. Decreasing the size of the lens aperture
  3. Decreasing the focal length of the lens
  4. Decreasing the speed of the lens
- 10-37. Which of the following f/numbers is NOT a major step?
1. f/1.4
  2. f/2.8
  3. f/4.5
  4. f/5.6
- 10-38. Which of the following f/stops allows the least amount of light to reach the film?
1. f/5.6
  2. f/8
  3. f/22
  4. f/45

10-39. Moving the diaphragm control one full stop requires doubling the time of exposure. What effect does that setting change have on the aperture opening and the exposure?

1. It increases the aperture opening and doubles the exposure
2. It decreases the aperture opening and halves the exposure
3. It decreases the aperture opening but does not change the exposure
4. It increases the aperture opening but does not change the exposure

10-40. To stop movement or action in a picture, you should consider all except which of the following details?

1. The relative movement of the subject
2. The subject's direction of movement
3. The camera-to-subject distance
4. The depth of field

10-41. Depth of field depends on all except which of the following factors?

1. The focal length of the lens
2. The lens aperture
3. The distance focused on
4. The sensitivity of the film

10-42. With a given camera and lens system, what factor affecting the depth of field can NOT be changed by the cameraman?

1. The lens opening
2. The focus distance
3. The focal length of the lens

10-43. You want to photograph an object in sharp detail with the background out of focus. The object is six feet from your camera lens. What is the best f/stop setting?

1. f/4.5
2. f/11
3. f/16
4. f/32

IN ANSWERING QUESTIONS 10-44 THROUGH 10-49, ASSUME THAT THE SUBJECT IS 25 FEET FROM THE CAMERA AND IS MOVING IN THE DIRECTION AS DESCRIBED IN FIGURE 11-21 OF THE TEXTBOOK. SELECT THE RESPONSE OF THE MINIMUM SHUTTER SPEED SETTING FOR EACH ACTION USED AS THE QUESTION.

10-44. A base runner in a baseball game running at right angles to the line of sight of the camera.

1. 1/125 sec
2. 1/250 sec
3. 1/500 sec
4. 1/1000 sec

10-45. A boy riding a bicycle toward you at about 8 miles per hour.

1. 1/125 sec
2. 1/250 sec
3. 1/500 sec
4. 1/1000 sec

10-46. A horse galloping toward you in a diagonal direction.

1. 1/125 sec
2. 1/250 sec
3. 1/500 sec
4. 1/1000 sec

10-47. An automobile accelerating in front of and away from you at about 35 miles per hour.

1. 1/125 sec
2. 1/250 sec
3. 1/500 sec
4. 1/1000 sec

- 10-48. A football-play taken at right angles to the motion.
1. 1/125 sec
  2. 1/250 sec
  3. 1/500 sec
  4. 1/1000 sec
- 10-49. A motor boat moving away from you in a diagonal direction at about 8 miles per hour.
1. 1/125 sec
  2. 1/250 sec
  3. 1/500 sec
  4. 1/1000 sec
- 10-50. Other than water, only two solutions are required for basic photographic processing. One is a developer. What is the second solution called?
1. A stop bath solution
  2. A fixer
  3. A wetting agent
  4. A negative preserver
- 10-51. The solution that causes silver halides on exposed film to change chemically into metallic silver is known by what terminology?
1. Fixer
  2. Wetting agent
  3. Developer
  4. Stop bath
- 10-52. The possibility of water spots forming on film as it dries is reduced by what photo processing solution?
1. The hypo
  2. Running water
  3. The wetting agent
  4. The fixer
- 10-53. Before you open a film cassette or film roll to begin processing, which of the following conditions must exist?
1. The room temperature must be between 50 and 65 degrees
  2. The room must be totally dark
  3. The room must be illuminated by only a red safety light
- 10-54. The silver halides not changed to metallic silver are converted into soluble salts by what photo processing solution?
1. The fixer
  2. The wetting agent
  3. The developer
  4. The stop bath
- 10-55. In processing exposed film, you must perform the following steps: (a) develop the latent image, (b) eliminate the chemicals used, (c) fix the image and (d) stop the action. Which response lists these steps in the proper sequence?
1. b, d, c, a
  2. c, a, b, d
  3. a, d, c, b
  4. a, c, b, d
- 10-56. Hypo is the common name of the solution used for what purpose?
1. To fix the negative
  2. To harden the emulsion on the negative
  3. To neutralize the developer
  4. To change the silver salts to silver
- 10-57. When processing film, you should maintain the water within what temperature range in degrees Fahrenheit?
1. 75 to 85
  2. 65 to 75
  3. 45 to 55
  4. 32 to 40

- 10-58. Which of the following data is NOT required on a Navy photo job order?
1. Number of views needed
  2. Description of the job to be photographed
  3. Type of film to use
  4. Size and finish of prints
- 10-59. A system that allows you to take and store photos electronically is known by what terminology?
1. Computer photography
  2. Still digital photography
  3. Electronic camera
- 10-60. Using your computer, you can send a digital photograph to all except which of the following outlets?
1. Another computer via modem
  2. A hard drive for storage
  3. A printer for a print
  4. A darkroom for further processing
- 10-61. Which of the following is a serious disadvantage in using a still digital camera?
1. The image cannot be cropped
  2. The camera needs up to eight seconds between shots
  3. The photos are black and white only
  4. You cannot tell how many shots you have already taken

## ASSIGNMENT 11

Textbook Assignment: "Basic Photojournalism" and "Radio," pages 12-1 through 13-9.

- 11-1. Photojournalists normally communicate by which of the following methods?
1. Photographs only
  2. Carefully worded copy only
  3. A harmonious combination of photographs and words
  4. One dynamic photograph that portrays the essence of a news story

- 11-2. What is the primary objective of a photojournalist?
1. To write interesting captions that adequately describe the photographs
  2. To communicate primarily through well-written copy
  3. To tell the Navy story in whatever form that best suits a given event or situation
  4. To communicate primarily through photographs

- 11-6. News photographs may NOT be used to accomplish which of the following objectives?
1. Supplement feature stories
  2. Support headlines and spot news stories
  3. Present a different idea to each person who sees the photograph
  4. Act as independent stories when accompanied by a cutline

- 11-7. Almost all press photography is classified into what two categories?
1. Movies and stills
  2. Spot news and features
  3. Advance news and spot news
  4. Hometown news and spot news
- 11-8. The spot news photo differs from the feature photo in that the spot news photo is affected by what other factor?

IN ANSWERING QUESTIONS 11-3 THROUGH 11-5, SELECT FROM COLUMN B THE HISTORICAL PERIOD IN WHICH PHOTOJOURNALISM WAS USED AS DESCRIBED IN COLUMN A. NOT ALL RESPONSES IN COLUMN B ARE USED.

<u>A. USES</u>	<u>B. PERIODS</u>
11-3. Professional photographers used to record war as history and to present realistic scenes designed to shock	1. Spanish-American War 2. Civil War
11-4. Progress in producing film, more rapid transportation and photoengraving	3. World War I 4. Korean
11-5. Photojournalists sought to interpret the war by concentrating on individuals	

1. It is unrehearsed
2. It requires extensive planning
3. It permits the photographer to use lighting to establish a desired mood
4. It requires selection and posing of the subject for an effective shot

- 11-9. When you plan photographic coverage of a news event, which of the following goal(s) should you attempt to achieve?
1. Creative impressions through the use of people
  2. Pictures that tell a story within themselves, when necessary
  3. Simplicity and the human element
  4. All of the above

- 11-10. Which of the following is NOT an effective technique in planning pictorial coverage of a news event?
1. Preparing outlines and identification for personnel who you plan to photograph
  2. Planning the inclusion of real or implied action in the shot
  3. Preparing a complete shooting schedule and sticking to it
  4. Planning your shots to show only emotions or attitudes appropriate to the event

- 11-11. A storyboard should be included in which part of the photo-journalist's shooting script?
1. First part only
  2. Second part only
  3. Third part only
  4. Anywhere, depending on your preference

- 11-12. The reason(s) a planned photo feature will interest a particular audience should be listed in which of the following part of a photojournalist's shooting script?
1. First part only
  2. Second part only
  3. Third part only
  4. Anywhere, depending on your preference

IN ANSWERING QUESTIONS 11-13 THROUGH 11-15, SELECT FROM COLUMN B THE TECHNIQUE OF GOOD SCRIPT SHOOTING THAT IS BEST DESCRIBED BY THE DEFINITION IN COLUMN A. NOT ALL RESPONSES IN COLUMN A ARE USED.

	<u>A. DEFINITIONS</u>	<u>B. TECHNIQUES</u>
11-13.	A shot that is the same as the eye receives	1. Closeup 2. Long shot
11-14.	A shot that shows greater detail than the eye receives	3. Medium shot 4. Natural shot
11-15.	A shot that shows the subject in its entirety and relates it to its surroundings	

- 
- 11-16. In a picture story layout, the lead picture can be identified by which of the following factors?
1. It's the first picture in the sequence
  2. It's the picture that contains the essence of the story
  3. It's referred to directly in the outline
- 11-17. Assume that you are assigned to furnish regular photo coverage for the public affairs office. To be ready for this duty at all times, you should perform all except which of the following actions?
1. Have a camera and accessories assigned for your exclusive use
  2. Clean and test your equipment regularly
  3. Keep your equipment assembled in one place
  4. Make sure the PMS card is maintained up to date



- 11-18. Of the following attributes, which is the most difficult and important for a good news photographer to cultivate?
1. Mastering the mechanics of photography
  2. Developing an inquisitive nature
  3. Gaining a self-confident attitude
  4. Learning to work with sureness, deftness and thoroughness
- 11-19. When shooting good composition, you should give primary consideration to what element?
1. Creating the illusion of depth to the scene
  2. Selecting the lighting conditions
  3. Properly placing the subject within the area of the photo
  4. Selecting the proper supporting elements of the main subject
- 11-20. To keep composition simple while maintaining interest, you should use which of the following procedures?
1. Include several objects of equal interest
  2. Include as many lines and shapes as possible
  3. Use numerous objects scattered at random
  4. Use a single object with less conspicuous supporting elements
- 11-21. By portraying supporting elements in a simple composition, you achieve what objective?
1. Accentuate the main idea of the photograph
  2. Separate the subject into several interesting ideas
  3. Eliminate empty spaces in the photograph
  4. Eliminate the need of taking more than one shot of the scene
- 11-22. Assume that you are assigned to photograph the Naval station's new swimming pool to accompany a story about it in a local newspaper. Which of the following details is most likely to detract from the intended point of interest?
1. A number of spectators around the pool watching the water activities
  2. The lines of the sidewalks in the recreation tend to point toward the pool
  3. A pretty girl in a bathing suit is seated in the foreground facing the camera
  4. The bright reflection on the water is in sharp contrast to the dark trees in the background
- 11-23. Where may the point of interest be located when you apply the rule of thirds?
1. In any one of the nine areas formed by the vertical and horizontal lines
  2. In only the center area formed by the vertical and horizontal lines
  3. In any of the three areas formed between the two horizontal lines
  4. At any one of the intersections formed by the horizontal and vertical lines

- 11-24. Which of the following scenes describes the best use of a leading line?
1. A winding path beginning in the center foreground and leading to a cottage, the intended point of interest, at the top center of the picture
  2. A waterfall, the point of interest, in the upper left of the picture produces a small stream flowing diagonally to the lower right foreground
  3. A street beginning in the lower left corner of the scene leads to the point of interest, a mansion, in the upper right corner. The street has two intersections and several parked cars.
  4. A narrow river flows from the upper left of the picture to the lower right. An old grist mill, the intended point of interest, is situated on the bank of the river in the upper one-third of the scene

11-25. To suggest the great height of a building effectively, you should use which of the following techniques?

1. Tilt the camera upward from a low angle
2. Take a downward shot from a taller building
3. Include a nearby tree for a framing effect
4. Take an eye-level shot at sunrise or sunset so the light is coming from a low angle

11-26. To attract attention to the point of interest of a building, you should use which of the following photographic techniques?

1. Shoot the building from as far away as possible
2. Show a road starting in one corner, and going past the building
3. Frame the building with some trees, or some type of arch
4. Place several people in front of the building facing the camera

---

IN ANSWERING QUESTIONS 11-27 THROUGH 11-31, SELECT FROM COLUMN B THE COMPOSITIONAL LINE THAT ACHIEVES THE EFFECT IN COLUMN A. RESPONSES MAY BE USED MORE THAN ONCE.

	<u>A. EFFECTS</u>	<u>B. LINES</u>
11-27.	Action	1. Curved
11-28.	Dignity	2. Diagonal
11-29.	Beauty	3. Horizontal
11-30.	Tranquility	4. Vertical
11-31.	Strength	

---

11-32. The term "weight" in the discussion of a balanced composition has what meaning?

1. The relative size of an object
2. The amount of light reflected by an object
3. The object's size, shape, tone and location
4. The actual weight of an object in relation to a standard weight

11-33. To take a picture of a white dog and bring out its details, you should photograph it using which of the following techniques?

1. Against a dark background
2. In a very bright light
3. Against a white background
4. With backlighting and underexposure

11-34. Which of the following procedures is the best method for stressing depth in a photograph?

1. Using frontlighting principally
2. Keeping the foreground completely clear
3. Focusing for the greatest possible depth of field
4. Placing familiar objects in the background or foreground

11-35. What is the most critical factor in good action photography?

1. Timing
2. Perspective
3. Composition
4. Tone

11-39. Pictures selected to 4. Illustrated  
tell a complete story text  
and used with a text text  
that presents a separate  
but related story

11-40. Pictures chosen to attract attention and introduce a story

11-41. What type of picture story is the most difficult to develop?

1. Picture-text combination
2. Pure picture story
3. Picture story within text
4. Illustrated text

11-42. What are the two approaches that a photojournalist may apply to a subject?

1. Perspective and subjective
2. Subjective and objective
3. Objective and perspective
4. Subjective and interpretive

11-43. Photojournalists attempt to portray their feelings of the subject to the viewer by what approach?

1. Interpretive
2. Objective
3. Subjective
4. Perspective

IN ANSWERING QUESTIONS 11-36 THROUGH 11-40, SELECT FROM COLUMN B THE TYPE OF PICTURE STORY USED FOR THE EXAMPLE IN COLUMN A. RESPONSES MAY BE USED MORE THAN ONCE.

	<u>A. EXAMPLES</u>	<u>B. TYPES</u>
11-36.	Pictures that tell the main story supplemented with some related information	1. Pure picture 2. Picture text
11-37.	A series of pictures selected to stand alone in telling a story	combination 3. Picture story within text
11-38.	Pictures of Navy scenes chosen to give a nautical effect to a brochure	story

11-44. In general, you should NOT take informal portraits of subjects in which of the following locations?

1. Their work areas
2. A studio
3. Their homes
4. In recreational areas

11-45. What parts of the subject are important in the informal portrait?

1. The hands and face
2. The shoulders and head
3. The chin and mouth
4. The mouth and eyes

- 11-46. Which of the following is NOT a technical requirement of a good news photograph?
1. Important details well lighted and emphasized
  2. Good composition consisting of leading lines and based on the rule of thirds
  3. Enough contrast so important halftones will not be lost in reproduction
  4. Sharp focus on the main points of interest
- 11-47. Which of the following groups of words lists the elements of radio writing?
1. Music, conflict and voice
  2. Sound, music and voice
  3. Conflict, sound and voice
  4. Conflict, music and voice
- 11-48. What is the most important element of radio writing?
1. Sound
  2. Conflict
  3. Voice
  4. Music
- 11-49. According to radio writers, the backbone of interest in radio writing is which of the following techniques?
1. Pacing and timing
  2. Aural sense appeal
  3. Conflict
  4. Rapid getaway
- 11-50. Broadcast copy with all unnecessary words trimmed away is writing that adheres to which of the following principles?
1. Clarity
  2. Conciseness
  3. Correctness
  4. Conversation
- 11-51. The hallmark of broadcast journalism as a writing art is that copy must have what element?
1. Color
  2. Conversational tone
  3. Accuracy
  4. Interesting angle
- 11-52. Broadcast news copy normally has what type of lead?
1. Who
  2. What
  3. When
  4. Why
- 11-53. What primary factor governs the length of most radio news stories?
1. Contents
  2. Time
  3. Announcer discretion
  4. Commercial value
- 11-54. In introducing the name of an individual into a news story, which of the following examples indicates the recommended style of use?
1. John Smith, city councilman
  2. The Honorable Joseph Sims, Mayor of Fort Worth
  3. Baseball great Joe DiMaggio
  4. Caspar Weinberger, Secretary of Defense
- 11-55. Which of the following statements is a recommended rule for broadcast writing?
1. Ignore colorful words in hard news copy
  2. Use a person's middle initial, when available, in all copy
  3. Use contractions whenever possible
  4. Use numbers whenever possible at the beginning of a lead to catch listener interest

- 11-56. Which of the following statements is NOT a broadcast writing rule concerning abbreviations?
1. Avoid starting a sentence with an abbreviation
  2. When in doubt about using an abbreviation, write it out
  3. The use of abbreviations for most military installations is permissible
  4. Never abbreviate the names of states
- 11-57. "She sells seashells by the seashore" is an example of which of the following grammatical terms?
1. Alliteration only
  2. Sibilants only
  3. Both alliteration and sibilants
  4. Homonyms
- 11-58. A fund drive netted \$10,421.10. How should that amount appear when included in a radio news release on the drive?
1. \$10,000
  2. \$10,421.10
  3. 10-thousand-400 dollars
  4. Ten thousand, four hundred dollars
- 11-59. What verb tense is the most effective for broadcast news?
1. Present tense only
  2. Past tense only
  3. Future tense only
  4. The one most natural to a given situation
- 11-60. Which of the following sentences is written in the active voice?
1. The speech was delivered by Dr. Smith
  2. The speech will be delivered by Dr. Smith
  3. Dr. Smith delivered the speech
- 11-61. As a general rule of thumb, you should keep broadcast copy sentences within a maximum length of how many words?
1. 14
  2. 20
  3. 25
  4. 40
- 11-62. Which of the following styles is best for most radio writing?
1. Formal
  2. Forceful
  3. Conversational
  4. Impersonal
- 11-63. Broadcast copy is constructed to allow for easy editing by deleting sentences from the bottom up.
1. True
  2. False
- 11-64. Question and quotation leads should NEVER be used in hard news stories.
1. True
  2. False

## ASSIGNMENT 12

Textbook Assignment: "Radio," "Television," and "Radio and Television Interviewing," pages 13-9 through 15-8.

- |   | IN ANSWERING QUESTIONS 12-5 THROUGH 12-7,<br>SELECT FROM COLUMN B THE PUNCTUATION MARK<br>THAT SERVES THE FUNCTION DESCRIBED IN<br>COLUMN A. NOT ALL RESPONSES IN COLUMN B<br>ARE USED.   |                     |                 |  |  |  |  |   |  |  |   |
|---|---|---------------------|-----------------|--|--|--|--|---|--|--|---|
|   | <table style="width: 100%; border-collapse: collapse;"> <thead> <tr> <th style="width: 50%; text-align: center;"><u>A. FUNCTIONS</u></th> <th style="width: 50%; text-align: center;"><u>B. MARKS</u></th> </tr> </thead> <tbody> <tr> <td style="vertical-align: top;"> <p>12-1. Radio listeners should be alerted to quoted material in the body of a news story by the use of the word "quote" preceding the remarks and the word "unquote" following the statement.</p> <p>1. True<br/>2. False</p> </td> <td style="vertical-align: top;"> <p>12-5. Indicates a pause shorter than that of a period</p> </td> </tr> <tr> <td style="vertical-align: top;"> <p>12-2. For which of the following reasons is the hyphen used in broadcast copy?</p> <p>1. To help announcers phrase difficult words<br/>2. To instruct announcers to pronounce individual elements of a word distinctly<br/>3. Both 1 and 2 above<br/>4. To tell announcers to pause a bit longer than at a corona</p> </td> <td style="vertical-align: top;"> <p>12-6. Sets off information that is not to be read aloud</p> <p>12-7. Sets off parenthetical information</p> </td> </tr> <tr> <td style="vertical-align: top;"> <p>12-3. The body of the broadcast news story may be developed in which of the following patterns?</p> <p>1. Chronological, descending importance or expanding the five Ws<br/>2. Upright pyramid, ascending importance or expanding the five Us<br/>3. Chronological, inverted pyramid or suspense building<br/>4. Upright pyramid, inverted pyramid or ascending importance</p> </td> <td style="vertical-align: top;"> <p>12-8. When preparing broadcast copy, you should observe all except which of the following practices?</p> <p>1. Number each page<br/>2. Double-space all lines of type<br/>3. Split sentences between pages<br/>4. Use all uppercase letters</p> </td> </tr> <tr> <td style="vertical-align: top;"> <p>12-4. In writing the body of a broadcast story, which of the following rules apply?</p> <p>1. Repeat all names used in the lead<br/>2. Give complete identification of persons named in the lead<br/>3. Save one or more of the important facts for a punch close<br/>4. Present the most important facts first</p> </td> <td style="vertical-align: top;"> <p>12-9. When you type broadcast copy, your typewriter margin should be set for an average of how many spaces per line?</p> <p>1. 30<br/>2. 45<br/>3. 60<br/>4. 75</p> <p>12-10. When broadcast copy is prepared correctly, approximately how many lines of type equal 30 seconds of reading time by an average announcer?</p> <p>1. 2 to 4<br/>2. 7 to 8<br/>3. 11 to 12<br/>4. 14 to 16</p> </td> </tr> </tbody> </table> | <u>A. FUNCTIONS</u> | <u>B. MARKS</u> | <p>12-1. Radio listeners should be alerted to quoted material in the body of a news story by the use of the word "quote" preceding the remarks and the word "unquote" following the statement.</p> <p>1. True<br/>2. False</p> | <p>12-5. Indicates a pause shorter than that of a period</p> | <p>12-2. For which of the following reasons is the hyphen used in broadcast copy?</p> <p>1. To help announcers phrase difficult words<br/>2. To instruct announcers to pronounce individual elements of a word distinctly<br/>3. Both 1 and 2 above<br/>4. To tell announcers to pause a bit longer than at a corona</p> | <p>12-6. Sets off information that is not to be read aloud</p> <p>12-7. Sets off parenthetical information</p> | <p>12-3. The body of the broadcast news story may be developed in which of the following patterns?</p> <p>1. Chronological, descending importance or expanding the five Ws<br/>2. Upright pyramid, ascending importance or expanding the five Us<br/>3. Chronological, inverted pyramid or suspense building<br/>4. Upright pyramid, inverted pyramid or ascending importance</p> | <p>12-8. When preparing broadcast copy, you should observe all except which of the following practices?</p> <p>1. Number each page<br/>2. Double-space all lines of type<br/>3. Split sentences between pages<br/>4. Use all uppercase letters</p> | <p>12-4. In writing the body of a broadcast story, which of the following rules apply?</p> <p>1. Repeat all names used in the lead<br/>2. Give complete identification of persons named in the lead<br/>3. Save one or more of the important facts for a punch close<br/>4. Present the most important facts first</p> | <p>12-9. When you type broadcast copy, your typewriter margin should be set for an average of how many spaces per line?</p> <p>1. 30<br/>2. 45<br/>3. 60<br/>4. 75</p> <p>12-10. When broadcast copy is prepared correctly, approximately how many lines of type equal 30 seconds of reading time by an average announcer?</p> <p>1. 2 to 4<br/>2. 7 to 8<br/>3. 11 to 12<br/>4. 14 to 16</p> |
| <u>A. FUNCTIONS</u>   | <u>B. MARKS</u>   |                     |                 |  |  |  |  |   |  |  |   |
| <p>12-1. Radio listeners should be alerted to quoted material in the body of a news story by the use of the word "quote" preceding the remarks and the word "unquote" following the statement.</p> <p>1. True<br/>2. False</p>  | <p>12-5. Indicates a pause shorter than that of a period</p>  |                     |                 |  |  |  |  |   |  |  |   |
| <p>12-2. For which of the following reasons is the hyphen used in broadcast copy?</p> <p>1. To help announcers phrase difficult words<br/>2. To instruct announcers to pronounce individual elements of a word distinctly<br/>3. Both 1 and 2 above<br/>4. To tell announcers to pause a bit longer than at a corona</p>  | <p>12-6. Sets off information that is not to be read aloud</p> <p>12-7. Sets off parenthetical information</p>  |                     |                 |  |  |  |  |   |  |  |   |
| <p>12-3. The body of the broadcast news story may be developed in which of the following patterns?</p> <p>1. Chronological, descending importance or expanding the five Ws<br/>2. Upright pyramid, ascending importance or expanding the five Us<br/>3. Chronological, inverted pyramid or suspense building<br/>4. Upright pyramid, inverted pyramid or ascending importance</p> | <p>12-8. When preparing broadcast copy, you should observe all except which of the following practices?</p> <p>1. Number each page<br/>2. Double-space all lines of type<br/>3. Split sentences between pages<br/>4. Use all uppercase letters</p>  |                     |                 |  |  |  |  |   |  |  |   |
| <p>12-4. In writing the body of a broadcast story, which of the following rules apply?</p> <p>1. Repeat all names used in the lead<br/>2. Give complete identification of persons named in the lead<br/>3. Save one or more of the important facts for a punch close<br/>4. Present the most important facts first</p>  | <p>12-9. When you type broadcast copy, your typewriter margin should be set for an average of how many spaces per line?</p> <p>1. 30<br/>2. 45<br/>3. 60<br/>4. 75</p> <p>12-10. When broadcast copy is prepared correctly, approximately how many lines of type equal 30 seconds of reading time by an average announcer?</p> <p>1. 2 to 4<br/>2. 7 to 8<br/>3. 11 to 12<br/>4. 14 to 16</p>   |                     |                 |  |  |  |  |   |  |  |   |

12-11. Approximately how many words make up a 60-second story read by an average announcer?

1. 50
2. 100
3. 150
4. 200

12-12. Besides the slugline and the type of release submitted, what information should be contained in the four-unit heading of a broadcast script?

1. Name of writer and telephone number
2. Date the copy is written and the length of copy
3. Brief summary of the release and length of the copy
4. Length of the copy and the date the copy is to be released

12-13. Which of the following practices applies to in-house broadcast copy?

1. Copy must be absolutely clean
2. The same copy-editing marks as those used by the print media are used by broadcasters
3. Broadcast editing methods are used
4. No special concern is paid to the appearance of broadcast copy

12-14. What are the forms of spot announcements?

1. Selling and appeal
2. Information and selling
3. Attention and information
4. Information and action

12-15. Which of the following elements describe the three-pronged approach to structuring a selling spot announcement?

1. Research, target and delivery
2. Attention, audience and activity
3. Estimate, energize and execute
4. Attention, appeal and action

12-16. What important step in a selling spot is unnecessary in an information spot?

1. The attention-getting step
2. The audience-targeting step
3. The call for audience response step
4. The audience research step

In a telephone interview with the Chairman of the Armed Forces Day program for your area, you obtained the information in figure 12-A below. Your PAO wants you to write a spot announcement on the program for broadcast over local, commercial radio stations.

- 
- A. Armed Forces Day is scheduled for May 13 and 14.
  - B. Exciting exhibits and demonstrations will be held at Naval Air Station North Island.
  - C. Admission is free.
  - D. The program begins on Saturday the 14th at 1245.
  - E. This is a chance to get a first-hand look at over a thousand exhibits of our latest military equipment, including our newest missile and supersonic aircraft.
  - F. Ample free parking is available for 25,000 cars.
  - G. Additionally, there will be aerial demonstrations by the Armed Forces; acrobatic flying by the Navy's Blue Angels and the Air Force's Thunderbirds; a simulated attack on an enemy position by Army Ranger units; plus a demonstration of Marine Corps invasion techniques using helicopters.

Figure 12-A.

IN ANSWERING QUESTIONS 12-17 THROUGH 12-20. REFER TO FIGURE 12-A.

- 12-17. Which of the following examples of sentence F is the preferred form for radio spot announcements?
1. The base has available parking facilities for an estimated 25,000 automobiles
  2. Ample free parking is available for 25 thousand cars
  3. Ample free parking is available for twenty-five thousand cars
  4. Parking facilities for 25 thousand cars are available, according to the Chairman of the Armed Forces Day Committee
- 12-18. What changes should you make to sentence D for the spot announcement?
1. Spell out the numerals for the date "14th"
  2. Spell out the numerals for the hours only
  3. Spell out the numerals for the dates and hours
  4. Use "12:45 p.m." instead of "1245"
- 12-19. What changes should you make in sentence G?
1. Rewrite it in several short sentences
  2. Add more details
  3. Simplify the vocabulary used
  4. Delete part of it
- 12-20. What is the best way for you to rephrase the information in line B so the sentence is in spot announcement style?
1. The public is invited. . .
  2. Everyone is invited. . .
  3. You're invited. . .
  4. All of you are invited. . .
- 12-21. In which part of a spot announcement would you put the following sentence: "Navy fighter planes and Army Rangers are invading NAS North Island?"
1. At the beginning
  2. Immediately after the beginning
  3. In the body of the message
  4. After the message
- 12-22. Assume that you are preparing radio copy for a 30-second recruiting spot that will include 10 seconds of "Anchors Aweigh" music. You should limit your copy to approximately how many words?
1. 50
  2. 75
  3. 100
  4. 150
- 12-23. How should you indicate to the radio station that a spot announcement should not be used indefinitely?
1. Attach a note to the copy saying new material will be furnished every two weeks
  2. Include a cut-off time and "kill date" with the spot
  3. When you hand the radio copy to the news manager, tell him when you will replace it
  4. When you telephone the spot to the station, tell the announcer how many times it may be read
- 12-24. Which of the following groups of words indicates the methods of interviewing?
1. Semi-scripted, fully-scripted and ad-lib
  2. Ad-lib, canned and semi ad-lib
  3. Fully-scripted, ad-lib and semi ad-lib
  4. Ad-lib, questionnaire and fully-scripted

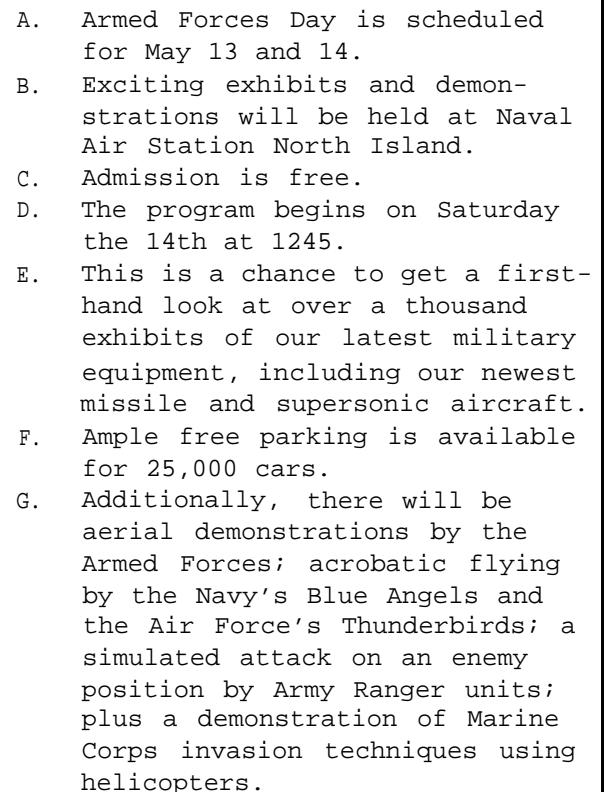

12-25. What method is usually the recommended way for a Navy journalist to conduct most radio interviews?

1. Semi ad-lib
2. Semi-scripted
3. Ad-lib
4. Fully-scripted

12-31. Assume that J03 Peters has arranged a recorded interview with Lieutenant Bowers who has been flown back to the United States after surviving for two weeks in a life raft in the Mediterranean Sea. Which of the following procedures should Peters NOT observe?

1. Asking questions that require Lt. Bowers to do most of the talking and avoiding questions that could be answered with a simple yes or no
2. Rehearsing to the extent that Lt. Bowers may have a chance to memorize most of his answers
3. Lowering his voice to the same level as Lt. Bowers' if the officer begins to answer in a lower tone
4. Making a brief, light explanation to relieve the awkwardness when an ashtray is knocked off a table and clatters to the floor.

---

IN ANSWERING QUESTIONS 12-26 THROUGH 12-29, SELECT FROM COLUMN B THE BASIC TYPE OF INTERVIEW THAT IS DESCRIBED IN COLUMN A. RESPONSES MAY BE USED MORE THAN ONCE.

<u>A. SAMPLE INTERVIEW</u>	<u>B. TYPE</u>
12-26. The President presents the Medal of Honor to a Navy member who grants an interview.	1. Personality 2. Informative
12-27. A senator is interviewed for his opinions on increasing sea power.	3. Combination
12-28. A Navy pilot is rescued from a crash at sea. The pilot's home-town radio reporter asks the well-known pilot about his experiences while adrift.	
12-29. A Navy officer is asked to discuss the usefulness of new equipment.	

---

IN ANSWERING QUESTIONS 12-32 THROUGH 12-35, SELECT FROM COLUMN B THE TYPE OF TV AREA THAT MATCHES THE DESCRIPTION IN COLUMN A. RESPONSES MAY BE USED MORE THAN ONCE.

<u>A. DESCRIPTION</u>	<u>B. AREA</u>
12-32. All of the area transmitted by the television camera	1. Essential area 2. Border area
12-33. Area that provides a background in case of over-scanning	3. Scanning area
12-34. Area seen by the TV viewer	
12-35. Handling area that provides protection for a picture or other artwork if dropped	

---

12-30. Which of the following points should an interviewer consider for an interview?

1. Propriety, good taste and accuracy
2. Timeliness and location of the interview
3. Newsworthiness
4. All of the above

12-36. Which, if any, of the following areas of limitation are required by each television visual?

1. Scanning and border
2. Essential and scanning
3. Border and essential
4. None of the above

12-37. The aspect ratio of television cameras and television receivers means they are designed in which of the following shapes?

1. Three units wide to three units high
2. Three units high to four units wide
3. Four units high to four units wide
4. Four units high to three units wide

12-38. The portion of a picture seen by a television camera that does not appear on television receivers is known by what term?

1. Transmission loss
2. Overscan
3. Essential area
4. Vertical filter

12-42. Which of the following television shots is considered the most common and efficient?

1. Medium long shot (MLS)
2. Medium close-up (MCU)
3. Close-up (CU)
4. Extreme close-up (ECU)

12-43. Movement in front of the camera, usually by the talent, is referred to as what type of movement?

1. Primary movement
2. Secondary movement
3. Tertiary movement

12-44. What camera movement will provide the viewer with a high or low perspective of the subject?

1. Pan
2. Dolly
3. Pedestal
4. Tilt

12-45. If the homecoming shooting script calls for several closeup shots of persons waiting on the pier and long shots of the ships maneuvering to their berths, how will the close-ups most likely be used in the finished product?

1. As cut-ins
2. As cutaways
3. As compilations
4. As cut-ups

---

IN ANSWERING QUESTIONS 12-39 THROUGH 12-41, SELECT FROM COLUMN B THE EDITING TECHNIQUE DESCRIBED IN COLUMN A. NOT ALL RESPONSES IN COLUMN B ARE USED.

A. DESCRIPTION	B. TECHNIQUE
12-39. Matched cuts that maintain the flow of action	1. Compilation cutting
12-40. Depends on narration to tie scenes together	2. Consistency cutting
12-41. Employs various transitional devices	3. Continuity cutting
	4. Composite cutting

12-46. A series of shots shows a sailor on one of the ships searching the crowd for familiar faces, then waving and finally running down the brow to greet his family. If these scenes were interspersed with shots of his family responding to his wave, then moving closer to the brow as he approached, this method used by the film or tape editor would be an example of which of the following transitional devices?

1. Cutaway
2. Cut-in
3. Both 1 and 2 above
4. Crosscutting

- 12-47. When writing the script to accompany a taped or filmed news release, you should observe which of the following practices?
1. Use the pictures to supplement the narration
  2. Let the narration supplement the picture
  3. Never include in the narration details that are presented by the picture
  4. Never include in the narration details not presented by the picture
- 12-48. In marking broadcast copy, the single slash mark (/) tells you to do which of the following actions?
1. Make a full stop and take a big breath
  2. Pause and take a short breath
  3. Pause for emphasis, take no breath
  4. Read the next passage carefully due to tricky pronunciation
- 12-49. When there are a lot of stumbles in your delivery, which of the following is the most likely cause?
1. Vision problems
  2. The brain getting ahead of the mouth
  3. Lack of practice with the copy
  4. Lack of concentration skills
- 12-50. Which of the following types of production music is used to set the mood for the production?
1. Fill
  2. Background
  3. Theme
  4. Bridge
- 12-51. Which of the following production concepts allows the broadcaster to adapt the vocal mood to the mood created by the other elements in the production?
1. Beginning to end
  2. Prerecorded voice
  3. Prerecorded music and sound effects
  4. Segmenting
- 12-52. Which control on the audio console should NEVER be adjusted by studio announcers?
1. AFRTS/Network selector button
  2. Output selector button
  3. Audition/Program master gain control
  4. Monitor selection switch
- 12-53. In which of the following production phases should you review the script for unfamiliar words or names?
1. Preproduction
  2. Production
  3. Postproduction
- 12-54. Which of the following types of special effects adds depth to sounds and is used to enhance the voice?
1. Filtering
  2. Equalization
  3. Reverb
  4. Phasing
- 12-55. Which of the following components is the heart of the TV system?
1. Control room
  2. CCU
  3. Camera
  4. VCR
- 12-56. What causes "snow" on a TV picture?
1. Too little light on the subject
  2. A camera that needs adjusting
  3. A CCU out of sync with the camera it is mated with
  4. Low signal strength on the cable

- 12-57. What does the "T" stand for on the zoom servo switch?
1. Toggle
  2. Telephoto
  3. Towards (zoom in)
  4. Tight
- 12-58. Which of the following television production personnel is responsible for the special effects bank?
1. Director
  2. Floor manager
  3. Audio switcher
  4. Video switcher
- 12-59. Which of the following television production personnel acts as a liaison between the director and the talent?
1. Floor manager
  2. Camera operator
  3. Audio switcher
  4. Video switcher
- 12-60. Which of the following types of television visuals usually has a chroma-blue background?
1. Studio card
  2. Super key card
  3. Chroma key card
  4. Plain title card
- 12-61. What floor manager's hand signal is used to tell the talent to wrap it up?
1. Arm and hand rotating above the head
  2. The letter "T" formed with both hands
  3. A grabbing motion ending in a fist
  4. Hand across the throat in a slashing motion

## ASSIGNMENT 13

Textbook Assignment: "Public Affairs Office Operations" and "Home Town news," pages 16-1 through 17-12.

---

- 13-1. All except which of the following are departments within a public affairs office?
1. Media relations
  2. Internal relations
  3. Community relations
  4. Administration
- 13-2. What office or individual is responsible for writing flag officer's biographies?
1. Administration office
  2. Public affairs office
  3. The flag officer concerned
  4. The flag secretary
- 13-3. What public affairs file contains information about local military beat reporters?
1. command
  2. Media relations
  3. community relations
  4. Future
- 13-4. What public affairs file contains general background material on the Navy, such as "Navy Fact File"?
1. Command
  2. Project
  3. Speech
  4. Clip
- 13-5. In what public affairs file would you keep query sheets documenting the release of information orally?
1. Media relations
  2. Project
  3. Alibi
  4. News release
- 13-6. All except which of the following items should be found in a welcome aboard booklet?
1. Mission statement
  2. General unclassified command facts
  3. Biography of all senior officers
  4. Brief command history
- 13-7. What is the most logical order for the portion of a command presentation that describes your unit?
1. Strict chronological order based on when a department or section was established
  2. Straight from the organizational chart, starting at the top and working down
  3. Straight from the organizational chart, starting at the bottom and working up
  4. Start with the most important department and end with the least important
- 13-8. All except which of the following are rules for a good command presentation?
1. Avoid Navy acronyms
  2. Keep sentences short
  3. Keep charts and graphs simple
  4. Use a variety of styles for "word" slides
- 13-9. What is the recommended length for command presentations?
1. 5 to 10 minutes
  2. 10 to 12 minutes
  3. 15 to 20 minutes
  4. 20 to 25 minutes

- 13-10. What source is used as the basis for published naval histories?
1. Published newspaper and television accounts of command happenings
  2. Official correspondence files
  3. command histories
  4. Narratives from commanding officers
- 13-11. In what paragraph of a flag officer's biography would you find information about marital status and family members?
1. First only
  2. Any middle paragraph only
  3. Last only
  4. Any paragraph
- 13-12. The standard biography format has what size margin?
1. One-half inch
  2. Three-quarter inch
  3. One inch
  4. One and one-half inch
- 13-13. Which of the following titles in a flag officer's biography is capitalized correctly?
1. Commanding officer
  2. Fred Lemming, Commanding Officer
  3. Training Officer
  4. Fred Lemming, an Unrestricted Line Officer
- 13-14. What office or authority owns an official flag officer's biography and therefore has the ultimate say over its contents?
1. The public affairs office
  2. The flag officer concerned
  3. The Navy
  4. The flag secretary
- 13-15. What office or authority determines the newsworthiness of Navy news?
1. The public affairs office
  2. The commanding officer
  3. The media it is released to
  4. The nearest public affairs center
- 13-16. Which of the following media is the backbone of public information today?
1. Newspapers
  2. Television
  3. Radio
  4. News magazines
- 13-17. All except which of the following are advantages of radio as a mass communicator?
1. Immediacy
  2. Inexpensive radios
  3. Aural appeal
  4. Mobility
- 13-18. What media type is the most potent?
1. Newspapers
  2. Radio
  3. Television
  4. News magazines
- 13-19. You have received a request from Time magazine for help in completing an article about your command. How should you respond to this request?
1. Provide the information and file a copy in your alibi file
  2. Provide the information and forward a copy to CHINFO
  3. Forward the request to CHINFO for approval before providing any information
  4. Forward the request to your commanding officer before providing any information

- 13-20. What type of publication is the Public Affairs Communicator?
1. News magazine
  2. Consumer magazine
  3. Trade journal
  4. Internal memorandum
- 13-21. All except which of the following are key words for dealing with the media?
1. Accuracy
  2. Promptness
  3. Politeness
  4. Honesty
- 13-22. Which of the following is your most valuable asset when dealing with the media?
1. Accuracy
  2. Politeness
  3. Honesty
  4. Promptness
- 13-23. Which of the following statements is true of reporters traveling aboard Navy ships and aircraft?
1. Travel may be provided when commercial transportation is available, as long as it is necessary to obtain the news material
  2. Reporters may not use shipboard communications facilities
  3. Transportation does not have to be in the interest of the DoD or DON
  4. Detailed information about media embarks can be found in chapter 8 of PA Regs
- 13-24. All except which of the following should be included in a media information kit?
1. Biographies of senior officers
  2. command photographs
  3. Welcome aboard booklets
  4. Telephone numbers for the PAO and staff
- 13-25. In a news release about an upcoming day set aside for the public to visit your base, what phrase should be avoided?
1. General public visitation
  2. Open house
  3. Everyone invited
- 13-26. The psychological need for sailors to be recognized and appreciated is addressed by which of the following programs?
1. Community relations
  2. Hometown News
  3. Internal information
  4. CHINFO Merit Awards
- 13-27. What is the purpose of the homeowner?
1. To provide service members with current news from their respective hometowns
  2. To stimulate recruiting efforts in small towns
  3. To provide information on service members to major news media outlets
  4. To report the status and achievements of service members to the people in the member's hometown
- 13-28. Homeowners are processed and disseminated by which of the following activities?
1. CHINFO
  2. FHTNC
  3. Individual commands
  4. Various hometown news media organizations
- 13-29. The Navy's Fleet Home Town News Center serves all except which of the following organizations?
1. The Navy
  2. The Coast Guard
  3. The Marine Corps
  4. The National Health Service

- 13-30. A service member from all except which of the following areas is able to participate in the Home Town News program?
1. Alaska
  2. The Republic of the Philippines
  3. Guam
  4. American Samoa
- 13-31. To receive hometown material from the FHTNC, clients must meet which of the following requirements?
1. Agreeing to publish all material received
  2. Officially requesting the material
  3. Paying a nominal fee for each item received
- 13-32. Under most circumstances, individual commands are authorized to submit hometown news directly to which of the following activities?
1. All recognized news media
  2. The FHTNC
  3. All newspapers within 50 miles of the command
- 13-33. Hometown news feature material on specific individuals requested by the news media will normally be provided directly to the news media by which of the following activities?
1. The command receiving the request
  2. FHTNC
  3. Local recruiting office
  4. Nearest NAVINFO
- 13-34. In addition to instructions for filling out the NAVSO 5724/1 form, what information is presented on the back of that form?
1. A disclaimer
  2. The Freedom of Information statement
  3. The Privacy Act statement
  4. A list of news media authorized to receive the form directly from the command
- 13-35. In which of the following publications can you expect to find detailed information on submitting material to the FHTNC?
1. Fleet Home Town News Guide
  2. U.S. Navy Public Affairs Regulations
  3. Both 1 and 2 above
  4. The AP Stylebook and Libel Manual
- 13-36. Which of the following blocks must be filled out for the form to be accepted for processing by the FHTNC?
1. Block 17 - signature
  2. Block 19 - release number
  3. Block 7 - name(s) of parent(s)
  4. Block 15 - duties to which assigned
- 13-37. When 10 or more forms are submitted at the same time to the FHTNC, a releasing authority signature on the cover letter will satisfy the requirement for a signature in block 18 on each of the forms.
1. True
  2. False
- 13-38. All except which of the following news media have requested and receive hometown news material from the FHTNC?
1. Newspaper
  2. Radio stations
  3. Television stations
  4. news magazines
- 13-39. All except which of the following categories of stories are processed by the FHTNC?
1. Military achievement
  2. Personal achievement
  3. Wedding announcements
  4. Participation stories



- 13-40. A hold file is a collection of FHTNC forms that have what condition in common?
1. They are all about individuals who do not want any publicity
  2. They are all about the members of a unit whose forms are kept at the FHTNC while that unit is on extended deployment
  3. They are all the forms for sea service personnel participating in the program
  4. They are all the forms held by the public affairs office until enough are accumulated for mailing to the FHTNC

- 13-41. If an individual whose name is in a hold file reenlists or is promoted in rate during a deployment, what should the administrator of the unit's hometown news program do?
1. Have the individual fill out a new form and mail it to the FHTNC
  2. Notify the FHTNC by message of the event
  3. Ask the individual to reconsider his "no publicity" stand
  4. Nothing, since the individual has already requested no publicity

- 13-42. How often must hold files be updated?
1. Once a year
  2. Once, midway through the deployment
  3. Every 30 days
  4. Every 60 days

- 13-43. Under which of the following circumstances must the FHTNC be an addressee on death or serious injury messages?
1. Only when the dead or injured person's name is listed in the hold file
  2. Only when the dead or injured person's name is NOT in the hold file
  3. Only when the death or injury was-job related
  4. Under all circumstances

---

IN ANSWERING QUESTIONS 13-44 THROUGH 13-51, SELECT FROM COLUMN B THE STORY CATEGORY IDENTIFIED BY THE TOPIC LISTED IN COLUMN A. RESPONSES MAY BE USED MORE THAN ONCE.

	<u>A. TOPICS</u>	<u>B. CATEGORIES</u>
13-44.	Reenlistment	1. Military achievement
13-45.	Earned college degree	2. Personal achievement
13-46.	Reported aboard	3. Participating story
13-47.	Received award as Coach of the Year from local little league	
13-48.	Port visit of ship	
13-49.	Named Sailor of the Year	
13-50.	Promoted to 302	
13-51.	Received Good Conduct Medal	

---

- 13-52. A story about one person involved in one event would be submitted to the FHTNC as what type of story?
1. Roster
  2. Personal
  3. Individual
  4. Military achievement

- 13-53. What is (a) the minimum number of prints and (b) the type of prints required when photographs are submitted to FHTNC?
1. (a) Four (b) black and white wallet size prints
  2. (a) Six (b) color wallet size prints
  3. (a) Five (b) black and white wallet size prints
  4. (a) Four (b) color 8- by 10-inch prints
- 13-54. For single stories, negatives of any size are accepted by the FHTNC .
1. True
  2. False
- 13-55. Your 90-day logbook should contain what information?
1. Number of releases generated by each form
  2. news clippings of stories actually printed off each form
  3. Date form was mailed to the FHTNC



